

**mitsubishi  
electric**



# **INVERTER FR-E700**

## **INSTRUCTION MANUAL**

# **FR-E720-008 to 600 - NA FR-E740-016 to 170 - NA**

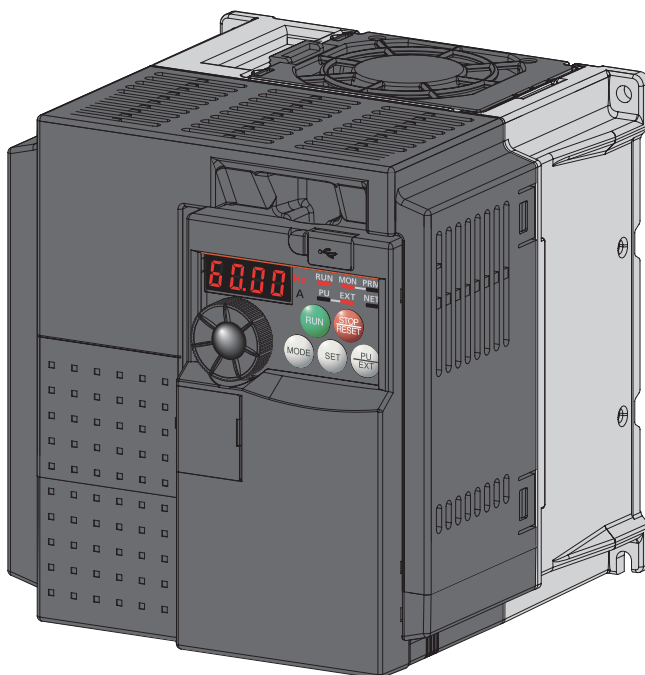

**OUTLINE**

**1**

**WIRING**

**2**

**PRECAUTIONS FOR USE  
OF THE INVERTER**

**3**

**PARAMETERS**

**4**

**TROUBLESHOOTING**

**5**

**PRECAUTIONS FOR  
MAINTENANCE AND INSPECTION**

**6**

**SPECIFICATIONS**

**7**

Thank you for choosing this Mitsubishi Inverter.

This Instruction Manual provides instructions for advanced use of the FR-E700 series inverters.

Incorrect handling might cause an unexpected fault. Before using the inverter, always read this instruction manual and the Installation Guideline [IB-0600333ENG] packed with the product carefully to use the equipment to its optimum performance.

**This section is specifically about safety matters**

Do not attempt to install, operate, maintain or inspect the inverter until you have read through the Instruction Manual and appended documents carefully and can use the equipment correctly. Do not use this product until you have a full knowledge of the equipment, safety information and instructions.

In this Instruction Manual, the safety instruction levels are classified into "WARNING" and "CAUTION".

**⚠ WARNING** Assumes that incorrect handling may cause hazardous conditions, resulting in death or severe injury.

**⚠ CAUTION** Assumes that incorrect handling may cause hazardous conditions, resulting in medium or slight injury, or may cause physical damage only.

Note that even the **⚠ CAUTION** level may lead to a serious consequence according to conditions. Please follow the instructions of both levels because they are important to personnel safety.

## 1. Electric Shock Prevention

### **⚠ WARNING**

- While power is on or when the inverter is running, do not open the front cover. Otherwise you may get an electric shock.
- Do not run the inverter with the front cover or wiring cover removed. Otherwise, you may access the exposed high-voltage terminals or the charging part of the circuitry and get an electric shock.
- Even if power is off, do not remove the front cover except for wiring or periodic inspection. You may access the charged inverter circuits and get an electric shock.
- Before starting wiring or inspection, switch off power, check to make sure that the operation panel indicator is off, wait for at least 10 minutes after the power supply has been switched off, and check that there are no residual voltage using a tester or the like. The capacitor is charged with high voltage for some time after power off and it is dangerous.
- This inverter must be earthed (grounded). Earthing (grounding) must conform to the requirements of national and local safety regulations and electrical code. (NEC section 250, IEC 536 class 1 and other applicable standards)
- Any person who is involved in the wiring or inspection of this equipment should be fully competent to do the work.
- Always install the inverter before wiring. Otherwise, you may get an electric shock or be injured.
- Perform setting dial and key operations with dry hands to prevent an electric shock. Otherwise you may get an electric shock.
- Do not subject the cables to scratches, excessive stress, heavy loads or pinching. Otherwise, you may get an electric shock.
- Do not change the cooling fan while power is on. It is dangerous to change the cooling fan while power is on.
- Do not touch the printed circuit board with wet hands. Otherwise, you may get an electric shock.
- When measuring the main circuit capacitor capacity, the DC voltage is applied to the motor for 1s at powering off. Never touch the motor terminal, etc. right after powering off to prevent an electric shock.

## 2. Fire Prevention

### **⚠ CAUTION**

- Install the inverter on an incombustible wall without holes, etc. Mounting it to or near combustible material can cause a fire.
- If the inverter has become faulty, switch off the inverter power. A continuous flow of large current could cause a fire.
- When using a brake resistor, make up a sequence that will turn off power when an alarm signal is output. Otherwise, the brake resistor may excessively overheat due to damage of the brake transistor and such, causing a fire.
- Do not connect a resistor directly to the DC terminals P/+, N/-. This could cause a fire.

### 3. Injury Prevention

#### CAUTION

- Apply only the voltage specified in the instruction manual to each terminal. Otherwise, burst, damage, etc. may occur.
- Ensure that the cables are connected to the correct terminals. Otherwise, burst, damage, etc. may occur.
- Always make sure that polarity is correct to prevent damage, etc. Otherwise, burst, damage, etc. may occur.
- While power is on or for some time after power-off, do not touch the inverter as they will be extremely hot. Doing so can cause burns.

### 4. Additional Instructions

Also note the following points to prevent an accidental failure, injury, electric shock, etc.

#### (1) Transportation and mounting

#### CAUTION

- Transport the product using the correct method that corresponds to the weight. Failure to observe this could lead to injuries.
- Do not stack the inverter boxes higher than the number recommended.
- Ensure that installation position and material can withstand the weight of the inverter. Install according to the information in the instruction manual.
- Do not install or operate the inverter if it is damaged or has parts missing.
- When carrying the inverter, do not hold it by the front cover; it may fall off or fail.
- Do not stand or rest heavy objects on the product.
- Check the inverter mounting orientation is correct.
- Prevent other conductive bodies such as screws and metal fragments or other flammable substance such as oil from entering the inverter.
- As the inverter is a precision instrument, do not drop or subject it to impact.
- Use the brake unit under the following environmental conditions: Otherwise, the inverter may be damaged.

Environment	Ambient Temperature	-10°C to +50°C (14°F to 122°F) (non-freezing)
	Ambient humidity	90%RH maximum (non-condensing)
	Storage temperature	-20°C to +65°C (-4°F to 149°F) *1
	Atmosphere	Indoors (free from corrosive gas, flammable gas, oil mist, dust and dirt)
	Altitude/vibration	Maximum 1000m (3280.80feet) above sea level for standard operation. After that derate by 3% for every extra 500m (1640.40feet) up to 2500m (8202feet) (92%) 5.9m/s <sup>2</sup> or less

\*1 Temperature applicable for a short time, e.g. in transit.

#### (2) Wiring

#### CAUTION

- Do not install a power factor correction capacitor or surge suppressor/capacitor type filter on the inverter output side.
- The connection orientation of the output cables U, V, W to the motor will affect the direction of rotation of the motor.

### (3) Trial run

#### CAUTION

- Before starting operation, confirm and adjust the parameters. A failure to do so may cause some machines to make unexpected motions.

### (4) Usage

#### WARNING

- When you have chosen the retry function, stay away from the equipment as it will restart suddenly after trip.
- Since  is valid only when functions are set (Refer to page 176), provide a circuit and switch separately to make an emergency stop (power off, mechanical brake operation for emergency stop, etc).
- Make sure that the start signal is off before resetting the inverter alarm. A failure to do so may restart the motor suddenly.
- The load used should be a three-phase induction motor only. Connection of any other electrical equipment to the inverter output may damage the equipment.
- Do not modify the equipment.
- Do not perform parts removal which is not instructed in this manual. Doing so may lead to fault or damage of the product.

#### CAUTION

- The electronic thermal relay function does not guarantee protection of the motor from overheating.
- Do not use a magnetic contactor on the inverter input for frequent starting/stopping of the inverter.
- Use a noise filter to reduce the effect of electromagnetic interference. Otherwise nearby electronic equipment may be affected.
- Take measures to suppress harmonics. Otherwise power supply harmonics from the inverter may heat/damage the power factor correction capacitor and generator.
- When a 400V class motor is inverter-driven, please use an insulation-enhanced motor or measures taken to suppress surge voltages. Surge voltages attributable to the wiring constants may occur at the motor terminals, deteriorating the insulation of the motor.
- When parameter clear or all parameter clear is performed, reset the required parameters before starting operations. Each parameter returns to the initial value.
- The inverter can be easily set for high-speed operation. Before changing its setting, fully examine the performances of the motor and machine.
- In addition to the inverter's holding function, install a holding device to ensure safety.
- Before running an inverter which had been stored for a long period, always perform inspection and test operation.
- For prevention of damage due to static electricity, touch nearby metal before touching this product to eliminate static electricity from your body.

**(5) Emergency stop**

**⚠ CAUTION**

- Provide a safety backup such as an emergency brake which will prevent the machine and equipment from hazardous conditions if the inverter fails.
- When the breaker on the inverter input side trips, check for the wiring fault (short circuit), damage to internal parts of the inverter, etc. Identify the cause of the trip, then remove the cause and power on the breaker.
- When any protective function is activated, take the appropriate corrective action, then reset the inverter, and resume operation.

**(6) Maintenance, inspection and parts replacement**

**⚠ CAUTION**

- Do not carry out a megger (insulation resistance) test on the control circuit of the inverter.

**(7) Disposal**

**⚠ CAUTION**

- Treat as industrial waste.

**General instruction**

Many of the diagrams and drawings in this Instruction Manual show the inverter without a cover, or partially open. Never operate the inverter in this manner. Always replace the cover and follow this Instruction Manual when operating the inverter.

# CONTENTS

<b>1</b>	<b>OUTLINE</b>	<b>1</b>
<b>1.1</b>	<b>Product checking and parts identification</b>	<b>2</b>
<b>1.2</b>	<b>Inverter and peripheral devices</b>	<b>3</b>
1.2.1	Peripheral devices	4
<b>1.3</b>	<b>Removal and reinstallation of the cover</b>	<b>5</b>
1.3.1	Front cover	5
1.3.2	Wiring cover	6
<b>1.4</b>	<b>Installation of the inverter and enclosure design</b>	<b>7</b>
1.4.1	Inverter installation environment	7
1.4.2	Cooling system types for inverter panel	9
1.4.3	Inverter placement	10
<b>2</b>	<b>WIRING</b>	<b>13</b>
<b>2.1</b>	<b>Wiring</b>	<b>14</b>
2.1.1	Terminal connection diagram	14
<b>2.2</b>	<b>Main circuit terminal specifications</b>	<b>15</b>
2.2.1	Specification of main circuit terminal	15
2.2.2	Terminal arrangement of the main circuit terminal, power supply and the motor wiring	15
2.2.3	Cables and wiring length	17
<b>2.3</b>	<b>Control circuit specifications</b>	<b>20</b>
2.3.1	Standard control circuit terminal	20
2.3.2	Changing the control logic	23
2.3.3	Wiring of control circuit	25
2.3.4	Wiring instructions	26
2.3.5	Connection to the PU connector	27
<b>2.4</b>	<b>Connection of stand-alone option unit</b>	<b>29</b>
2.4.1	Connection of a dedicated external brake resistor (MRS type, MYS type, FR-ABR) (FR-E720-030 or more, FR-E740-016 or more)	29
2.4.2	Connection of the brake unit (FR-BU2)	31
2.4.3	Connection of the high power factor converter (FR-HC)	32
2.4.4	Connection of the power regeneration common converter (FR-CV)	33
2.4.5	Connection of a DC reactor (FR-HEL)	33
<b>3</b>	<b>PRECAUTIONS FOR USE OF THE INVERTER</b>	<b>35</b>
<b>3.1</b>	<b>EMC and leakage currents</b>	<b>36</b>

3.1.1	Leakage currents and countermeasures .....	36
3.1.2	EMC measures .....	38
3.1.3	Power supply harmonics .....	40
<b>3.2</b>	<b>Installation of power factor improving reactor .....</b>	<b>41</b>
<b>3.3</b>	<b>Power-off and magnetic contactor (MC).....</b>	<b>42</b>
<b>3.4</b>	<b>Inverter-driven 400V class motor .....</b>	<b>43</b>
<b>3.5</b>	<b>Precautions for use of the inverter .....</b>	<b>44</b>
<b>3.6</b>	<b>Failsafe of the system which uses the inverter .....</b>	<b>46</b>
<b>4</b>	<b>PARAMETERS .....</b>	<b>49</b>
<hr/>		
<b>4.1</b>	<b>Operation panel .....</b>	<b>50</b>
4.1.1	Names and functions of the operation panel .....	50
4.1.2	Basic operation (factory setting) .....	51
4.1.3	Easy operation mode setting (easy setting mode) .....	52
4.1.4	Change the parameter setting value .....	53
4.1.5	Setting dial push .....	53
<b>4.2</b>	<b>Parameter list .....</b>	<b>54</b>
<b>4.3</b>	<b>Control mode .....</b>	<b>75</b>
4.3.1	Change the control method (Pr. 80, Pr. 81, Pr. 800) .....	76
<b>4.4</b>	<b>Adjust the output torque of the motor (current).....</b>	<b>77</b>
4.4.1	Manual torque boost (Pr. 0, Pr. 46) .....	77
4.4.2	Advance magnetic flux vector control (Pr. 71, Pr. 80, Pr. 81, Pr.89, Pr. 800) .....	79
4.4.3	General-purpose magnetic flux vector control (Pr. 71, Pr. 80, Pr. 81, Pr. 800) .....	82
4.4.4	Slip compensation (Pr. 245 to Pr. 247) .....	84
4.4.5	Stall prevention operation (Pr. 22, Pr. 23, Pr. 48, Pr. 66, Pr. 156, Pr. 157, Pr. 277) .....	85
<b>4.5</b>	<b>Limit the output frequency.....</b>	<b>89</b>
4.5.1	Maximum/minimum frequency (Pr. 1, Pr. 2, Pr. 18) .....	89
4.5.2	Avoid mechanical resonance points (frequency jumps) (Pr. 31 to Pr. 36).....	90
<b>4.6</b>	<b>Set V/F pattern.....</b>	<b>91</b>
4.6.1	Base frequency, voltage (Pr. 3, Pr. 19, Pr. 47).....	91
4.6.2	Load pattern selection (Pr. 14) .....	93
<b>4.7</b>	<b>Frequency setting by external terminals.....</b>	<b>95</b>
4.7.1	Operation by multi-speed operation (Pr. 4 to Pr. 6, Pr. 24 to Pr. 27, Pr. 232 to Pr. 239) .....	95
4.7.2	Jog operation (Pr. 15, Pr. 16) .....	97
4.7.3	Remote setting function (Pr. 59).....	99

<b>4.8</b>	<b>Setting of acceleration/deceleration time and acceleration/ deceleration pattern .....</b>	<b>102</b>
4.8.1	Setting of the acceleration and deceleration time (Pr. 7, Pr. 8, Pr. 20, Pr. 21, Pr. 44, Pr. 45, Pr. 147) .....	102
4.8.2	Starting frequency and start-time hold function (Pr. 13, Pr. 571).....	105
4.8.3	Acceleration/deceleration pattern (Pr. 29) .....	106
4.8.4	Shortest acceleration/deceleration (automatic acceleration/deceleration) (Pr. 61 to Pr. 63, Pr. 292, Pr. 293) .....	107
<b>4.9</b>	<b>Selection and protection of a motor.....</b>	<b>109</b>
4.9.1	Motor overheat protection (Electronic thermal O/L relay) (Pr. 9, Pr. 51) .....	109
4.9.2	Applied motor (Pr. 71, Pr. 450).....	111
4.9.3	To exhibit the best performance of the motor performance (offline auto tuning) (Pr. 71, Pr. 80 to Pr. 84, Pr. 90 to Pr. 94, Pr. 96, Pr. 859) .....	113
<b>4.10</b>	<b>Motor brake and stop operation .....</b>	<b>121</b>
4.10.1	DC injection brake (Pr. 10 to Pr. 12).....	121
4.10.2	Selection of a regenerative brake (Pr. 30, Pr. 70) .....	122
4.10.3	Stop selection (Pr. 250) .....	124
4.10.4	Stop-on contact control function (Pr. 6, Pr. 48, Pr. 270, Pr. 275, Pr. 276) .....	125
4.10.5	Brake sequence function (Pr. 278 to Pr. 283, Pr. 292) .....	127
<b>4.11</b>	<b>Function assignment of external terminal and control .....</b>	<b>131</b>
4.11.1	Input terminal function selection (Pr. 178 to Pr. 184).....	131
4.11.2	Inverter output shutoff signal (MRS signal, Pr. 17).....	133
4.11.3	Condition selection of function validity by second function selection signal (RT).....	134
4.11.4	Start signal operation selection (STF, STR, STOP signal, Pr. 250) .....	135
4.11.5	Output terminal function selection (Pr. 190 to Pr. 192).....	137
4.11.6	Detection of output frequency (SU, FU signal, Pr. 41 to Pr. 43).....	141
4.11.7	Output current detection function (Y12 signal, Y13 signal, Pr. 150 to Pr. 153) .....	142
4.11.8	Remote output selection (REM signal, Pr. 495 to Pr. 497).....	144
<b>4.12</b>	<b>Monitor display and monitor output signal.....</b>	<b>145</b>
4.12.1	Speed display and speed setting (Pr. 37).....	145
4.12.2	Monitor display selection of DU/PU and terminal AM (Pr. 52, Pr.158, Pr. 170, Pr. 171, Pr. 268, Pr. 563, Pr. 564) .....	146
4.12.3	Reference of the terminal AM (analog voltage output) (Pr. 55, Pr. 56).....	151
4.12.4	Terminal AM calibration (calibration parameter Pr. 645, C1 (Pr.901)).....	152
<b>4.13</b>	<b>Operation selection at power failure and instantaneous power failure .....</b>	<b>154</b>
4.13.1	Automatic restart after instantaneous power failure/flying start (Pr. 30, Pr. 57, Pr. 58, Pr. 96, Pr. 162, Pr. 165, Pr. 298, Pr. 299, Pr. 611).....	154
4.13.2	Power-failure deceleration stop function (Pr. 261).....	160
<b>4.14</b>	<b>Operation setting at fault occurrence.....</b>	<b>162</b>

4.14.1	Retry function (Pr. 65, Pr. 67 to Pr. 69) .....	162
4.14.2	Input/output phase loss protection selection (Pr. 251, Pr. 872).....	164
4.14.3	Earth (ground) fault detection at start (Pr. 249).....	164
<b>4.15</b>	<b>Energy saving operation.....</b>	<b>165</b>
4.15.1	Optimum excitation control (Pr. 60).....	165
<b>4.16</b>	<b>Motor noise, EMI measures, mechanical resonance.....</b>	<b>166</b>
4.16.1	PWM carrier frequency and soft-PWM control (Pr. 72, Pr. 240).....	166
4.16.2	Speed smoothing control (Pr. 653).....	167
<b>4.17</b>	<b>Frequency setting by analog input (terminal 2, 4) .....</b>	<b>168</b>
4.17.1	Analog input selection (Pr. 73, Pr. 267).....	168
4.17.2	Response level of analog input and noise elimination (Pr. 74).....	170
4.17.3	Bias and gain of frequency setting voltage (current) (Pr. 125, Pr. 126, Pr. 241, C2 (Pr. 902) to C7 (Pr. 905)) .....	171
<b>4.18</b>	<b>Misoperation prevention and parameter setting restriction.....</b>	<b>176</b>
4.18.1	Reset selection/disconnected PU detection/PU stop selection (Pr. 75) .....	176
4.18.2	Parameter write disable selection (Pr. 77).....	179
4.18.3	Reverse rotation prevention selection (Pr. 78) .....	180
4.18.4	Extended parameter display and user group function (Pr. 160, Pr. 172 to Pr. 174).....	180
<b>4.19</b>	<b>Selection of operation mode and operation location .....</b>	<b>183</b>
4.19.1	Operation mode selection (Pr. 79).....	183
4.19.2	Operation mode at power-on (Pr. 79, Pr. 340) .....	193
4.19.3	Start command source and frequency command source during communication operation (Pr. 338, Pr. 339, Pr. 550, Pr. 551).....	194
<b>4.20</b>	<b>Communication operation and setting .....</b>	<b>200</b>
4.20.1	Wiring and configuration of PU connector .....	200
4.20.2	Initial settings and specifications of RS-485 communication (Pr. 117 to Pr. 120, Pr. 123, Pr. 124, Pr. 549) .....	203
4.20.3	Operation selection at communication error occurrence (Pr. 121, Pr. 122, Pr. 502).....	204
4.20.4	Communication EEPROM write selection (Pr. 342) .....	207
4.20.5	Mitsubishi inverter protocol (computer link communication).....	208
4.20.6	Modbus RTU communication specifications (Pr. 117, Pr. 118, Pr. 120, Pr. 122, Pr. 343, Pr. 502, Pr. 549).....	220
4.20.7	USB communication (Pr. 547, Pr. 548) .....	233
<b>4.21</b>	<b>Special operation and frequency control .....</b>	<b>234</b>
4.21.1	PID control (Pr. 127 to Pr. 134) .....	234
4.21.2	Dancer control (Pr. 44, Pr. 45, Pr. 128 to Pr. 134) .....	241
4.21.3	Droop control (Pr. 286 to Pr. 287) .....	247
4.21.4	Regeneration avoidance function (Pr. 665, Pr. 882, Pr. 883, Pr. 885, Pr. 886).....	248
<b>4.22</b>	<b>Useful functions .....</b>	<b>250</b>



4.22.1	Cooling fan operation selection (Pr. 244) .....	250
4.22.2	Display of the life of the inverter parts (Pr. 255 to Pr. 259).....	251
4.22.3	Maintenance timer alarm (Pr. 503, Pr. 504).....	255
4.22.4	Current average value monitor signal (Pr. 555 to Pr. 557) .....	256
4.22.5	Free parameter (Pr. 888, Pr. 889) .....	258
<b>4.23</b>	<b>Setting from the parameter unit and operation panel .....</b>	<b>259</b>
4.23.1	RUN key rotation direction selection (Pr. 40).....	259
4.23.2	PU display language selection(Pr.145).....	259
4.23.3	Operation panel frequency setting/key lock operation selection (Pr. 161).....	260
4.23.4	Magnitude of frequency change setting (Pr. 295).....	262
4.23.5	Buzzer control (Pr. 990).....	263
4.23.6	PU contrast adjustment (Pr. 991) .....	263
<b>4.24</b>	<b>Parameter clear/ All parameter clear .....</b>	<b>264</b>
<b>4.25</b>	<b>Initial value change list .....</b>	<b>265</b>
<b>4.26</b>	<b>Check and clear of the faults history .....</b>	<b>266</b>
<b>5</b>	<b>TROUBLESHOOTING .....</b>	<b>269</b>
<hr/> <hr/>		
<b>5.1</b>	<b>Reset method of protective function.....</b>	<b>270</b>
<b>5.2</b>	<b>List of fault or alarm indications .....</b>	<b>271</b>
<b>5.3</b>	<b>Causes and corrective actions .....</b>	<b>272</b>
<b>5.4</b>	<b>Correspondences between digital and actual characters.....</b>	<b>280</b>
<b>5.5</b>	<b>Check first when you have some troubles .....</b>	<b>281</b>
5.5.1	Motor will not start.....	281
5.5.2	Motor generates abnormal noise .....	281
5.5.3	Motor generates heat abnormally .....	282
5.5.4	Motor rotates in opposite direction.....	282
5.5.5	Speed greatly differs from the setting .....	282
5.5.6	Acceleration/deceleration is not smooth .....	282
5.5.7	Motor current is large.....	282
5.5.8	Speed does not increase .....	282
5.5.9	Speed varies during operation.....	283
5.5.10	Operation mode is not changed properly.....	283
5.5.11	Operation panel display is not operating .....	283
5.5.12	Parameter write cannot be performed .....	283
<b>6</b>	<b>PRECAUTIONS FOR MAINTENANCE AND INSPECTION .....</b>	<b>285</b>
<hr/> <hr/>		
<b>6.1</b>	<b>Inspection items .....</b>	<b>286</b>

6.1.1	Daily inspection .....	286
6.1.2	Periodic inspection .....	286
6.1.3	Daily and periodic inspection .....	287
6.1.4	Display of the life of the inverter parts .....	288
6.1.5	Checking the inverter and converter modules .....	288
6.1.6	Cleaning .....	288
6.1.7	Replacement of parts .....	289
6.1.8	Inverter replacement.....	292

## **6.2 Measurement of main circuit voltages, currents and powers ..... 293**

6.2.1	Measurement of powers .....	295
6.2.2	Measurement of voltages and use of PT .....	295
6.2.3	Measurement of currents.....	296
6.2.4	Use of CT and transducer .....	296
6.2.5	Measurement of inverter input power factor .....	296
6.2.6	Measurement of converter output voltage (across terminals P-N) .....	296
6.2.7	Insulation resistance test using megger .....	297
6.2.8	Pressure test .....	297

## **7 SPECIFICATIONS 299**

---

### **7.1 Rating..... 300**

7.1.1	Inverter rating .....	300
-------	-----------------------	-----

### **7.2 Common specifications ..... 302**

### **7.3 Outline dimension drawings..... 303**

## **APPENDIX 307**

---

### **Appendix1 For customers who have replaced the conventional model with this inverter ..... 308**

Appendix 1-1	Replacement of the FR-E500 series .....	308
--------------	---	-----

# MEMO

# 1 OUTLINE

**This chapter explains the "OUTLINE" for use of this product. Always read the instructions before using the equipment**

1.1	Product checking and parts identification .....	2
1.2	Inverter and peripheral devices .....	3
1.3	Removal and reinstallation of the cover .....	5
1.4	Installation of the inverter and enclosure design .....	7

<Abbreviations>

PU ..... Operation panel and parameter unit (FR-PU04/FR-PU07)

Inverter ..... Mitsubishi inverter FR-E700 series

FR-E700 ..... Mitsubishi inverter FR-E700 series

Pr..... Parameter number

PU operation ..... Operation using the PU (operation panel/FR-PU04/FR-PU07)

External operation ..... Operation using the control circuit signals

Combined operation..... Operation using both the PU (operation panel/FR-PU04/FR-PU07) and external operation

Operation panel for E500, PA02..... FR-E500 series operation panel (FR-PA02-02)

Mitsubishi standard motor ..... SF-JR

Mitsubishi constant-torque motor ... SF-HRCA

<Trademarks>

- Microsoft and Visual C++ are registered trademarks of Microsoft Corporation in the United States and/or other countries.
- LONWORKS® is a registered trademark of Echelon Corporation in the U.S.A and other countries.
- DeviceNet® is a registered trademark of ODVA (Open DeviceNet Vender Association, Inc.).
- Company and product names herein are the trademarks and registered trademarks of their respective owners.

<Mark>

 **REMARKS** :Additional helpful contents and relations with other functions are stated

 **NOTE** :Contents requiring caution or cases when set functions are not activated are stated.

 **POINT** :Useful contents and points are stated.

 **Parameters referred to** : related parameters are stated.



# 1.1 Product checking and parts identification

Unpack the inverter and check the capacity plate on the front cover and the rating plate on the inverter side face to ensure that the product agrees with your order and the inverter is intact.

**● Inverter type**

FR - E740 - 095 - NA

No.	Voltage class
E720	Three-phase 200V class
E740	Three-phase 400V class

Displays the rated current

**Operation panel**  
(Refer to page 50)

**PU connector**  
(Refer to page 22)

**Voltage/current input switch**  
(Refer to page 20)

**USB connector cover**  
(Refer to page 233)

**Front cover**  
(Refer to page 5)

**PU connector cover**  
(Refer to page 27)

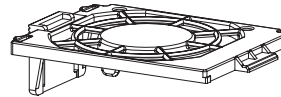

**Cooling fan**  
(Refer to page 289)

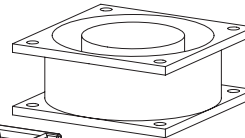

**USB connector (mini-B connector)**  
(Refer to page 233)

**Connector for plug-in option connection**  
(Refer to the instruction manual of options.)

**Standard control circuit terminal block**  
(Refer to page 20)

**Changing the control logic jumper connector**  
(Refer to page 23)

**Main circuit terminal block**  
(Refer to page 15)

**Combed shaped wiring cover**  
(Refer to page 6)

**Capacity plate \***

**FR-E740-095-NA** ← Inverter type

SERIAL: **XXXXXX** ← Serial number

**Rating plate \***

MITSUBISHI INVERTER

Inverter type → MODEL **FR-E740-095-NA**

Input rating → INPUT : XXXXX

Output rating → OUTPUT : XXXXX

Serial number → SERIAL : \_\_\_\_\_

PASSED

\* Location of the capacity plate and the rating plate differs according to the inverter capacity. Refer to the outline dimension drawing. (Refer to page 296)

**● Accessory**

- Fan cover fixing screws  
(Refer to *Installation Guideline*)

These screws are necessary for compliance with the European Directive

	Capacity	Screw Size (mm)	Number
200V	080 to 175	M3 × 35	1
	240 to 600	M3 × 35	2
400V	040 to 095	M3 × 35	1
	120 to 170	M3 × 35	2

## 1.2 Inverter and peripheral devices



**Three-phase AC power supply**  
Use within the permissible power supply specifications of the inverter.  
(Refer to page 300)



**Moulded case circuit breaker (MCCB) or earth leakage circuit breaker (ELB), fuse**  
The breaker must be selected carefully since an in-rush current flows in the inverter at power on.  
(Refer to page 4)



**Magnetic contactor (MC)**  
Install the magnetic contactor to ensure safety. Do not use this magnetic contactor to start and stop the inverter. Doing so will cause the inverter life to be shorten.  
(Refer to page 42)

**Reactor (FR-HAL, FR-HEL option)**  
Reactors (option) must be used when power harmonics measures are taken, the power factor is to be improved or the inverter is installed near a large power supply system (500kVA or more). The inverter may be damaged if you do not use reactors. Select the reactor according to the model. Remove the jumpers across terminals P/+ - P1 to connect the DC reactor.

AC reactor (FR-HAL)



DC reactor (FR-HEL)



**Noise filter (FR-BSF01, FR-BLF)**  
Install a noise filter to reduce the electromagnetic noise generated from the inverter. Effective in the range from about 1MHz to 10MHz. When more wires are passed through, a more effective result can be obtained. A wire should be wound four turns or more.



**Parameter unit (FR-PU07)**  
By connecting the connection cable (FR-CB2) to the PU connector, operation can be performed from FR-PU07.  
(Refer to page 27)

USB connector

A personal computer and an inverter can be connected with a USB (Ver1. 1) cable.  
(Refer to page 233)

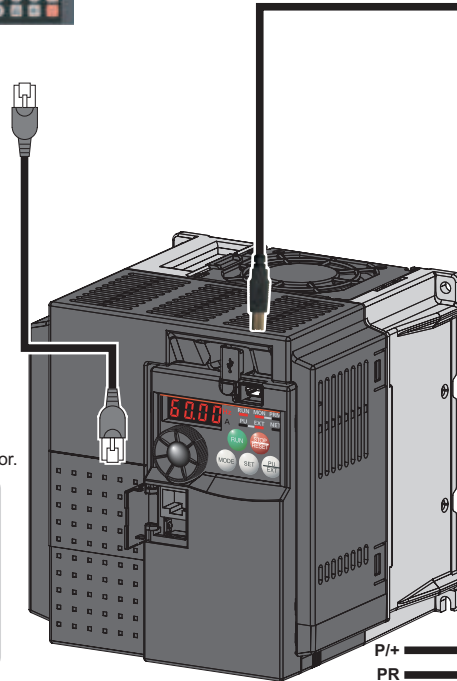

Inverter (FR-E700)

The life of the inverter is influenced by ambient temperature. The ambient temperature should be as low as possible within the permissible range. This must be noted especially when the inverter is installed in an enclosure. Refer to page 7  
Wrong wiring might lead to damage of the inverter. The control signal lines must be kept fully away from the main circuit to protect them from noise. (Refer to page 14)



**Brake resistor (FR-ABR, MRS, MYS)**  
Braking capability can be improved. (FR-E720-030 or more, FR-E740-016 or more)  
Always install a thermal relay when using a brake resistor whose capacity is 11K or more.

**Capacitor type filter (FR-BIF)**  
Reduces the radio noise.



Noise filter (FR-BSF01, FR-BLF)

Install a noise filter to reduce the electromagnetic noise generated from the inverter. Effective in the range from about 1MHz to 10MHz. A wire should be wound four turns at a maximum.



Motor



**High power factor converter (FR-HC)**  
Power supply harmonics can be greatly suppressed. Install this as required.



**Power regeneration common converter (FR-CV)**  
Great braking capability is obtained. Install this as required.



**Resistor unit (FR-BR) Discharging resistor (GZG, GRZG)**  
The regenerative braking capability of the inverter can be exhibited fully. Install this as required.



Devices connected to the output Earth (Ground)

Do not install a power factor correction capacitor, surge suppressor or capacitor type filter on the output side of the inverter. When installing a moulded case circuit breaker on the output side of the inverter, contact each manufacturer for selection of the moulded case circuit breaker.

Earth (Ground)

To prevent an electric shock, always earth (ground) the motor and inverter. For reduction of induction noise from the power line of the inverter, it is recommended to wire the earth (ground) cable by returning it to the earth (ground) terminal of the inverter.



### NOTE

- Do not install a power factor correction capacitor, surge suppressor or capacitor type filter on the inverter output side. This will cause the inverter to trip or the capacitor and surge suppressor to be damaged. If any of the above devices are connected, immediately remove them.
- Electromagnetic wave interference  
The input/output (main circuit) of the inverter includes high frequency components, which may interfere with the communication devices (such as AM radios) used near the inverter. In this case, install the FR-BIF optional capacitor type filter (for use in the input side only) or FR-BSF01 or FR-BLF common mode filter to minimize interference. (Refer to page 38).
- Refer to the instruction manual of each option and peripheral devices for details of peripheral devices.

## 1.2.1 Peripheral devices

Check the inverter type of the inverter you purchased. Appropriate peripheral devices must be selected according to the capacity.

Refer to the following list and prepare appropriate peripheral devices:

Inverter Type	Motor Output (kW (HP))	Moulded Case Circuit Breaker (MCCB) *1 or Earth Leakage Circuit Breaker (ELB) *4		Magnetic Contactor (MC)	
		Standard	With power factor improving reactor		
Three-Phase 200V	FR-E720-008	0.1 (1/8)	30AF 5A	30AF 5A	S-N10
	FR-E720-015	0.2 (1/4)	30AF 5A	30AF 5A	S-N10
	FR-E720-030	0.4 (1/2)	30AF 5A	30AF 5A	S-N10
	FR-E720-050	0.75 (1)	30AF 10A	30AF 10A	S-N10
	FR-E720-080	1.5 (2)	30AF 15A	30AF 15A	S-N10
	FR-E720-110	2.2 (3)	30AF 20A	30AF 15A	S-N10
	FR-E720-175	3.7 (5)	30AF 30A	30AF 30A	S-N20, S-N21
	FR-E720-240	5.5 (7.5)	50AF 50A	50AF 40A	S-N25
	FR-E720-330	7.5 (10)	100AF 60A	50AF 50A	S-N35
	FR-E720-470	11 (15)	100AF 75A	100AF 75A	S-N35
	FR-E720-600	15 (20)	225AF 125A	100AF 100A	S-N50
Three-Phase 400V	FR-E740-016	0.4 (1/2)	30AF 5A	30AF 5A	S-N10
	FR-E740-026	0.75 (1)	30AF 5A	30AF 5A	S-N10
	FR-E740-040	1.5 (2)	30AF 10A	30AF 10A	S-N10
	FR-E740-060	2.2 (3)	30AF 15A	30AF 10A	S-N10
	FR-E740-095	3.7 (5)	30AF 20A	30AF 15A	S-N20, S-N21
	FR-E740-120	5.5 (7.5)	30AF 30A	30AF 20A	S-N20, S-N21
	FR-E740-170	7.5 (10)	30AF 30A	30AF 30A	S-N20, S-N21

- \*1 •Select an MCCB according to the power supply capacity.  
•Install one MCCB per inverter.

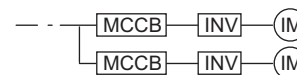

- \*2 When the inverter capacity is larger than the motor capacity, select an MCCB and a magnetic contactor according to the inverter type and cable and reactor according to the motor output.
- \*3 When the breaker on the inverter primary side trips, check for the wiring fault (short circuit), damage to internal parts of the inverter, etc. Identify the cause of the trip, then remove the cause and power on the breaker.
- \*4 For installations in the United States or Canada, use the class T type fuse certified by the UL and cUL.

## 1.3 Removal and reinstallation of the cover

### 1.3.1 Front cover

FR-E720-175 or less, FR-E740-170 or less

#### ●Removal

Remove the front cover by pulling it toward you in the direction of arrow.

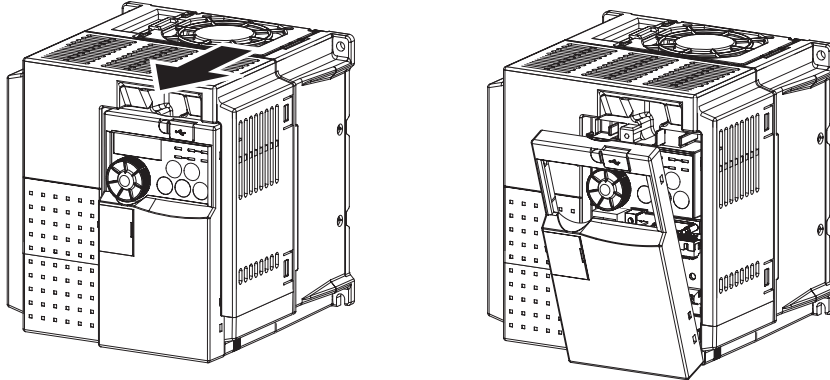

#### ●Reinstallation

To reinstall, match the cover to the inverter front and install it straight.

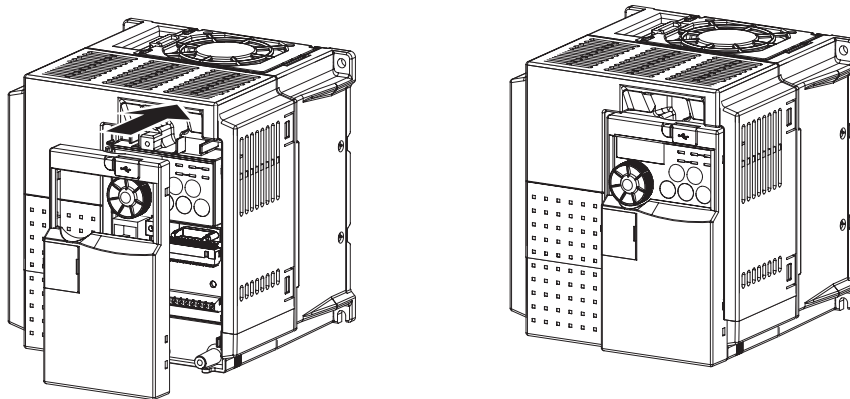

FR-E720-240 to 600

#### ●Removal

- 1) Loosen the installation screws of the front cover 1.
- 2) Remove the front cover 1 by pulling it toward you in the direction of arrow.
- 3) Remove the front cover 2 by pulling it toward you in the direction of arrow.

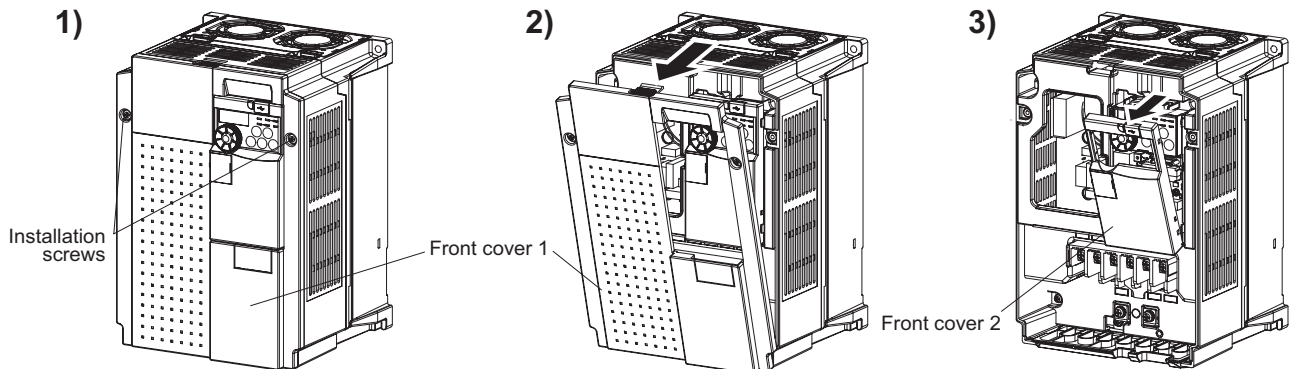



### ● Reinstallation

- 1) Match the front cover 2 to the inverter front and install it straight.
- 2) Insert the two fixed hooks on the left side of the front cover 1 into the sockets of the inverter.
- 3) Tighten the screw of the front cover 1.

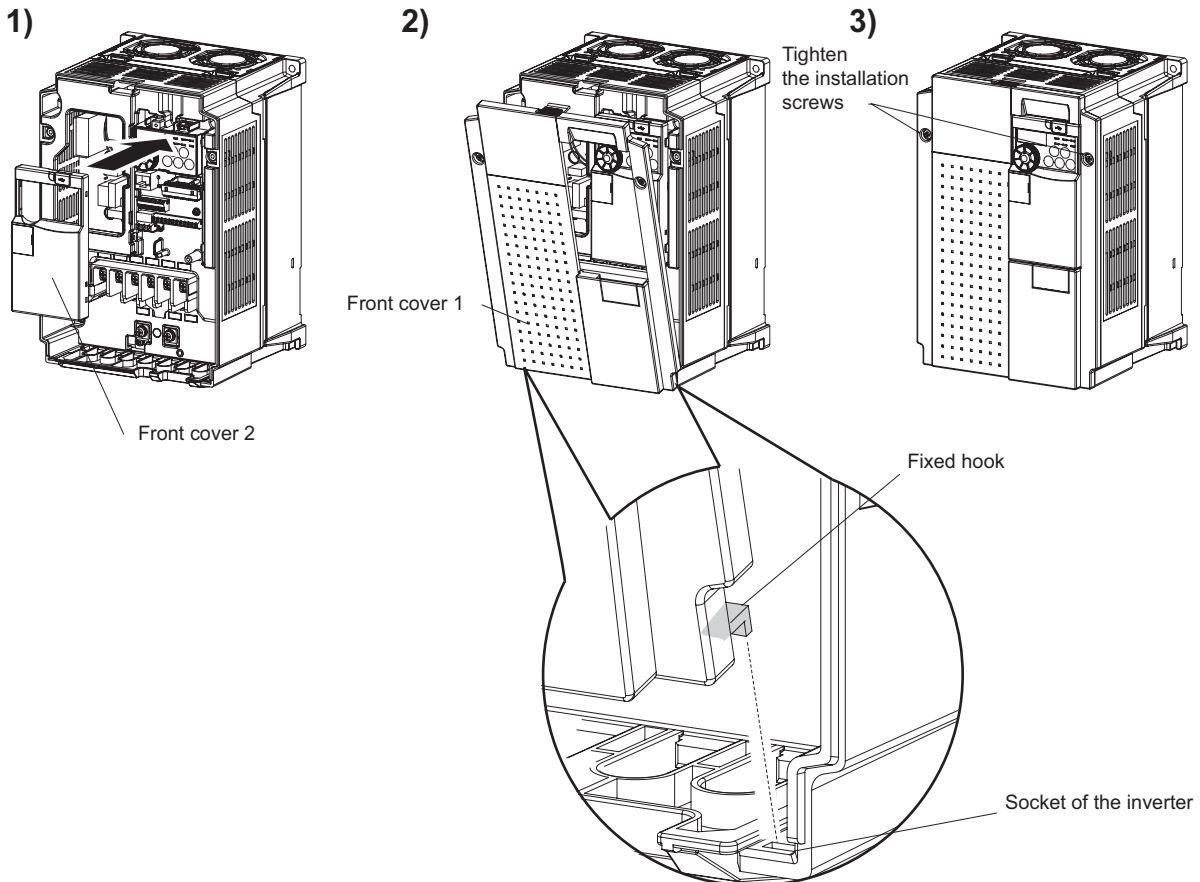

### NOTE

- Fully make sure that the front cover has been reinstalled securely.
- The same serial number is printed on the capacity plate of the front cover and the rating plate of the inverter. Since these plates have the same serial numbers, always reinstall the removed cover onto the original inverter.

### 1.3.2 Wiring cover

#### ● Removal and reinstallation

The cover can be removed easily by pulling it toward you. To reinstall, fit the cover to the inverter along the guides.

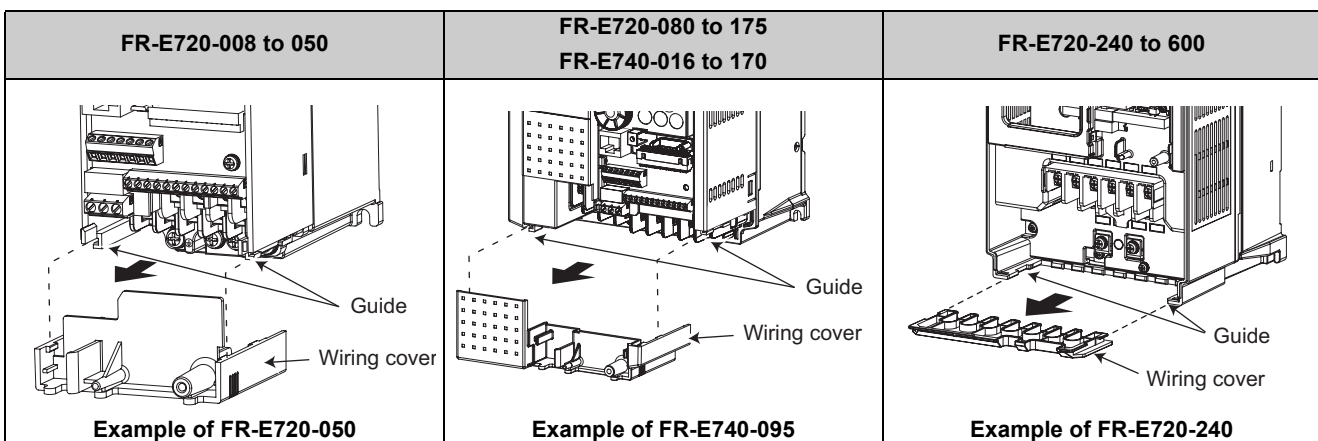

## 1.4 Installation of the inverter and enclosure design

When an inverter panel is to be designed and manufactured, heat generated by contained equipment, etc., the environment of an operating place, and others must be fully considered to determine the panel structure, size and equipment layout. The inverter unit uses many semiconductor devices. To ensure higher reliability and long period of operation, operate the inverter in the ambient environment that completely satisfies the equipment specifications.

### 1.4.1 Inverter installation environment

As the inverter installation environment should satisfy the standard specifications indicated in the following table, operation in any place that does not meet these conditions not only deteriorates the performance and life of the inverter, but also causes a failure. Refer to the following points and take adequate measures.

**Environmental standard specifications of inverter**

Item	Description
Ambient temperature	-10 to +50°C (14°F to 122°F)(non-freezing)
Ambient humidity	90%RH maximum (non-condensing)
Atmosphere	Free from corrosive and explosive gases, free from dust and dirt
Maximum altitude	1,000m (3280.80 feet) or less
Vibration	5.9m/s <sup>2</sup> or less

#### (1) Temperature

The permissible ambient temperature of the inverter is between -10 and +50°C (14°F to 122°F). Always operate the inverter within this temperature range. Operation outside this range will considerably shorten the service lives of the semiconductors, parts, capacitors and others. Take the following measures so that the ambient temperature of the inverter falls within the specified range.

- 1) Measures against high temperature
  - Use a forced ventilation system or similar cooling system. (*Refer to page 9*)
  - Install the panel in an air-conditioned electrical chamber.
  - Block direct sunlight.
  - Provide a shield or similar plate to avoid direct exposure to the radiated heat and wind of a heat source.
  - Ventilate the area around the panel well.
- 2) Measures against low temperature
  - Provide a space heater in the enclosure.
  - Do not power off the inverter. (Keep the start signal of the inverter off.)
- 3) Sudden temperature changes
  - Select an installation place where temperature does not change suddenly.
  - Avoid installing the inverter near the air outlet of an air conditioner.
  - If temperature changes are caused by opening/closing of a door, install the inverter away from the door.

#### (2) Humidity

Normally operate the inverter within the 45 to 90% range of the ambient humidity. Too high humidity will pose problems of reduced insulation and metal corrosion. On the other hand, too low humidity may produce a spatial electrical breakdown. The insulation distance specified in JEM1103 "Control Equipment Insulator" is defined as humidity 45 to 85%.

- 1) Measures against high humidity
  - Make the panel enclosed, and provide it with a hygroscopic agent.
  - Take dry air into the enclosure from outside.
  - Provide a space heater in the enclosure.
- 2) Measures against low humidity
 

What is important in fitting or inspection of the unit in this status is to discharge your body (static electricity) beforehand and keep your body from contact with the parts and patterns, besides blowing air of proper humidity into the panel from outside.
- 3) Measures against condensation
 

Condensation may occur if frequent operation stops change the in-panel temperature suddenly or if the outside-air temperature changes suddenly.

Condensation causes such faults as reduced insulation and corrosion.

  - Take the measures against high humidity in 1).
  - Do not power off the inverter. (Keep the start signal of the inverter off.)

### **(3) Dust, dirt, oil mist**

Dust and dirt will cause such faults as poor contact of contact points, reduced insulation or reduced cooling effect due to moisture absorption of accumulated dust and dirt, and in-panel temperature rise due to clogged filter. In the atmosphere where conductive powder floats, dust and dirt will cause such faults as malfunction, deteriorated insulation and short circuit in a short time.

Since oil mist will cause similar conditions, it is necessary to take adequate measures.

#### Countermeasures

- Place in a totally enclosed enclosure.  
Take measures if the in-enclosure temperature rises. (*Refer to page 9*)
- Purge air.  
Pump clean air from outside to make the in-panel pressure higher than the outside-air pressure.

### **(4) Corrosive gas, salt damage**

If the inverter is exposed to corrosive gas or to salt near a beach, the printed board patterns and parts will corrode or the relays and switches will result in poor contact.

In such places, take the measures given in Section 3.

### **(5) Explosive, flammable gases**

As the inverter is non-explosion proof, it must be contained in an explosion proof enclosure. In places where explosion may be caused by explosive gas, dust or dirt, an enclosure cannot be used unless it structurally complies with the guidelines and has passed the specified tests. This makes the enclosure itself expensive (including the test charges). The best way is to avoid installation in such places and install the inverter in a non-hazardous place.

### **(6) Highland**

Use the inverter at the altitude of within 1000m (3280.80 feet). If it is used at a higher place, it is likely that thin air will reduce the cooling effect and low air pressure will deteriorate dielectric strength.

### **(7) Vibration, impact**

The vibration resistance of the inverter is up to  $5.9\text{m/s}^2$  at 10 to 55Hz frequency and 1mm amplitude. Vibration or impact, if less than the specified value, applied for a long time may make the mechanism loose or cause poor contact to the connectors. Especially when impact is imposed repeatedly, caution must be taken as the part pins are likely to break.

#### Countermeasures

- Provide the panel with rubber vibration isolators.
- Strengthen the structure to prevent the panel from resonance.
- Install the panel away from sources of vibration.

### 1.4.2 Cooling system types for inverter panel

From the panel that contains the inverter, the heat of the inverter and other equipment (transformers, lamps, resistors, etc.) and the incoming heat such as direct sunlight must be dissipated to keep the in-panel temperature lower than the permissible temperatures of the in-panel equipment including the inverter.

The cooling systems are classified as follows in terms of the cooling calculation method.

- 1) Cooling by natural heat dissipation from the enclosure surface (totally enclosed type)
- 2) Cooling by heat sink (aluminum fin, etc.)
- 3) Cooling by ventilation (forced ventilation type, pipe ventilation type)
- 4) Cooling by heat exchanger or cooler (heat pipe, cooler, etc.)

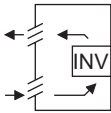
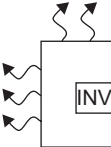
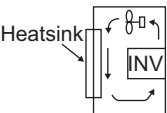
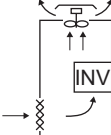
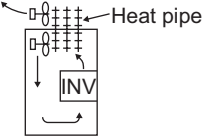
Cooling System		Panel Structure	Comment
Natural cooling	Natural ventilation (enclosed, open type)		Low in cost and generally used, but the panel size increases as the inverter capacity increases. For relatively small capacities.
	Natural ventilation (totally enclosed type)		Being a totally enclosed type, the most appropriate for hostile environment having dust, dirt, oil mist, etc. The panel size increases depending on the inverter capacity.
Forced cooling	Fin cooling		Having restrictions on the heatsink mounting position and area, and designed for relative small capacities.
	Forced ventilation		For general indoor installation. Appropriate for panel downsizing and cost reduction, and often used.
	Heat pipe		Totally enclosed type for panel downsizing.

## 1.4.3 Inverter placement

### (1) Installation of the inverter

#### Enclosure surface mounting

FR-E720-008 to 050

Remove the front cover and wiring cover to fix the inverter to the surface.

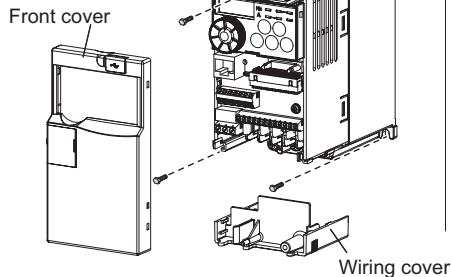

FR-E720-080 or more  
FR-E740-016 or more

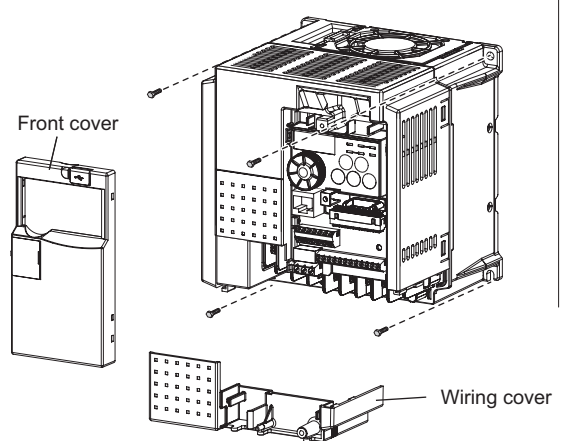

#### NOTE

- When encasing multiple brake units, install them in parallel as a cooling measure.
- Install the inverter vertically.

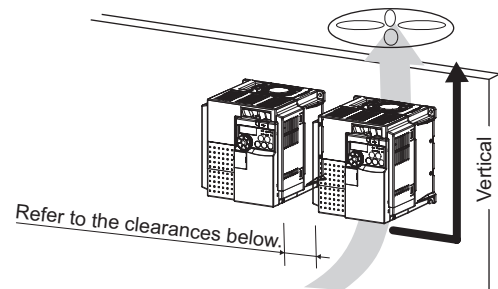

### (2) Clearances around inverter

To ensure ease of heat dissipation and maintenance, leave at least the shown clearances around the inverter. At least the following clearances are required under the inverter as a wiring space, and above the inverter as a heat dissipation space.

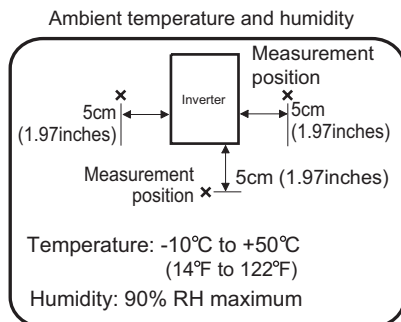

Leave enough clearances and take cooling measures.

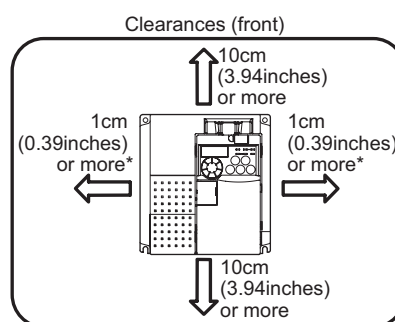

\* When using the inverters at the ambient temperature of 40°C (104°F) or less, the inverters can be installed without any clearance between them (0cm (0inch) clearance).  
When ambient temperature exceeds 40°C (104°F), clearances between the inverters should be 1cm (0.39inches) or more (5cm (1.97inches) or more for the FR-E720-240 and FR-E740-120, or more).

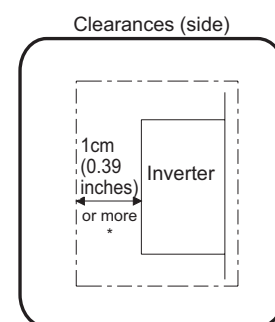

\* 5cm (1.97inches) or more for the FR-E720-240 and FR-E740-120, or more

### (3) Inverter mounting orientation

Mount the inverter on a wall as specified. Do not mount it horizontally or any other way.

### (4) Above inverter

Heat is blown up from inside the inverter by the small fan built in the unit. Any equipment placed above the inverter should be heat resistant.

**(5) Arrangement of multiple inverters**

When multiple inverters are placed in the same enclosure, generally arrange them horizontally as shown in the right figure (a). When it is inevitable to arrange them vertically to minimize space, take such measures as to provide guides since heat from the bottom inverters can increase the temperatures in the top inverters, causing inverter failures.

When mounting multiple inverters, fully take caution not to make the ambient temperature of the inverter higher than the permissible value by providing ventilation and increasing the panel size.

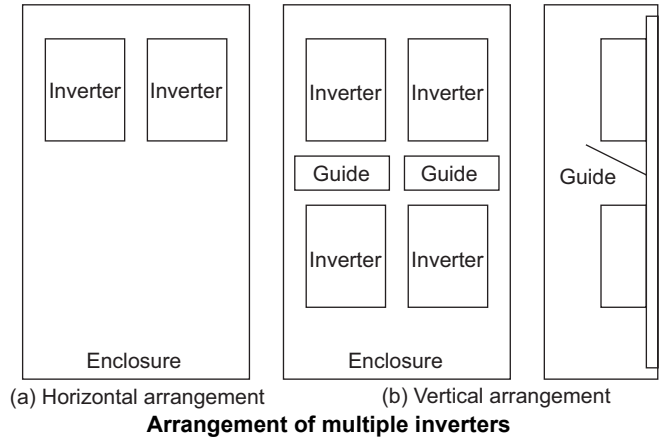

**(6) Arrangement of ventilation fan and inverter**

Heat generated in the inverter is blown up from the bottom of the unit as warm air by the cooling fan. When installing a ventilation fan for that heat, determine the place of ventilation fan installation after fully considering an air flow. (Air passes through areas of low resistance. Make an airway and airflow plates to expose the inverter to cool air.)

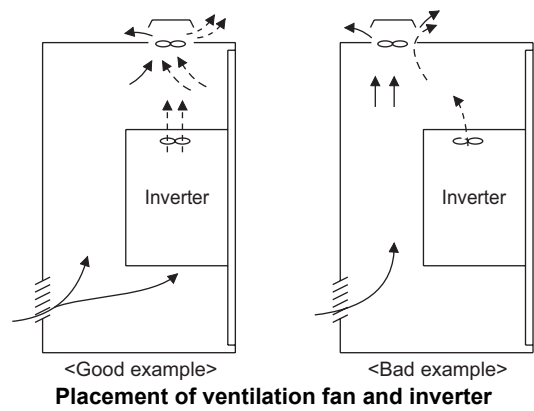

# MEMO

A large, stylized number '2' is formed by a thick green outline. The top horizontal bar of the '2' is filled with a light green color. The rest of the outline is empty. To the right of the '2' is the word 'WIRING' in a bold, black, sans-serif font.

# 2 WIRING

---

This chapter describes the basic "WIRING" for use of this product.

Always read the instructions before using the equipment

---

2.1	Wiring.....	14
2.2	Main circuit terminal specifications .....	15
2.3	Control circuit specifications .....	20
2.4	Connection of stand-alone option unit .....	29

1

2

3

4

5

6

7



## 2.1 Wiring

### 2.1.1 Terminal connection diagram

- Three-phase 200V power input
- Three-phase 400V power input

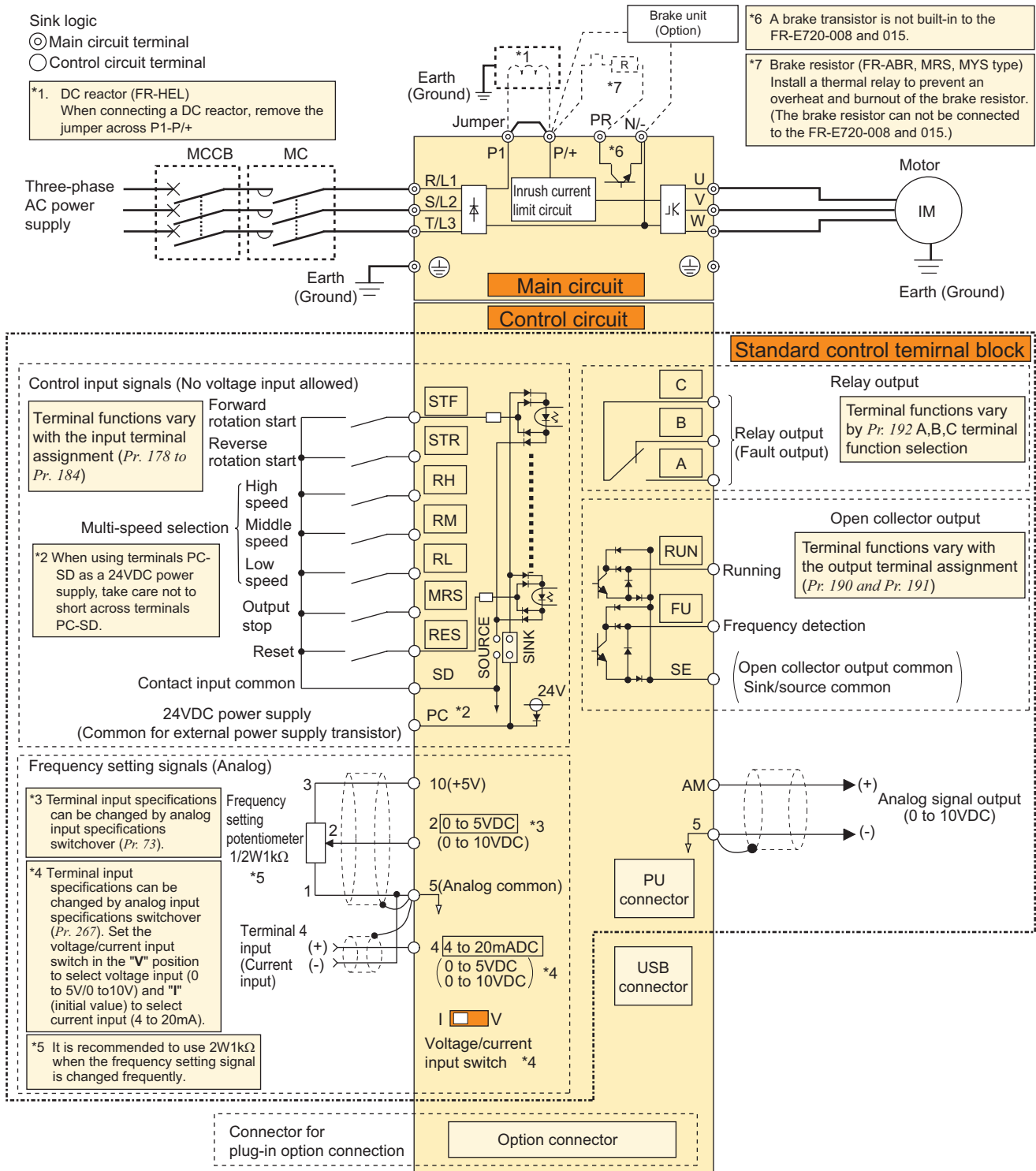

**NOTE**

- To prevent a malfunction caused by noise, separate the signal cables more than 10cm (3.94inches) from the power cables.
- After wiring, wire offcuts must not be left in the inverter.  
 Wire offcuts can cause an alarm, failure or malfunction. Always keep the inverter clean. When drilling mounting holes in an enclosure etc., take care not to allow chips and other foreign matter to enter the inverter.

## 2.2 Main circuit terminal specifications

### 2.2.1 Specification of main circuit terminal

Terminal Symbol	Terminal Name	Description
R/L1, S/L2, T/L3	AC power input	Connect to the commercial power supply. Keep these terminals open when using the high power factor converter (FR-HC) or power regeneration common converter (FR-CV).
U, V, W	Inverter output	Connect a three-phase squirrel-cage motor.
P/+, PR	Brake resistor connection	Connect a brake transistor (FR-ABR, MRS, MYS) across terminals P/+ -PR. (The brake resistor can not be connected to the FR-E720-008 or 015.)
P/+, N/-	Brake unit connection	Connect the brake unit (FR-BU2), power regeneration common converter (FR-CV) or high power factor converter (FR-HC).
P/+, P1	DC reactor connection	Remove the jumper across terminals P/+ -P1 and connect a DC reactor.
	Earth (Ground)	For earthing (grounding) the inverter chassis. Must be earthed (grounded).

### 2.2.2 Terminal arrangement of the main circuit terminal, power supply and the motor wiring

#### 200V class

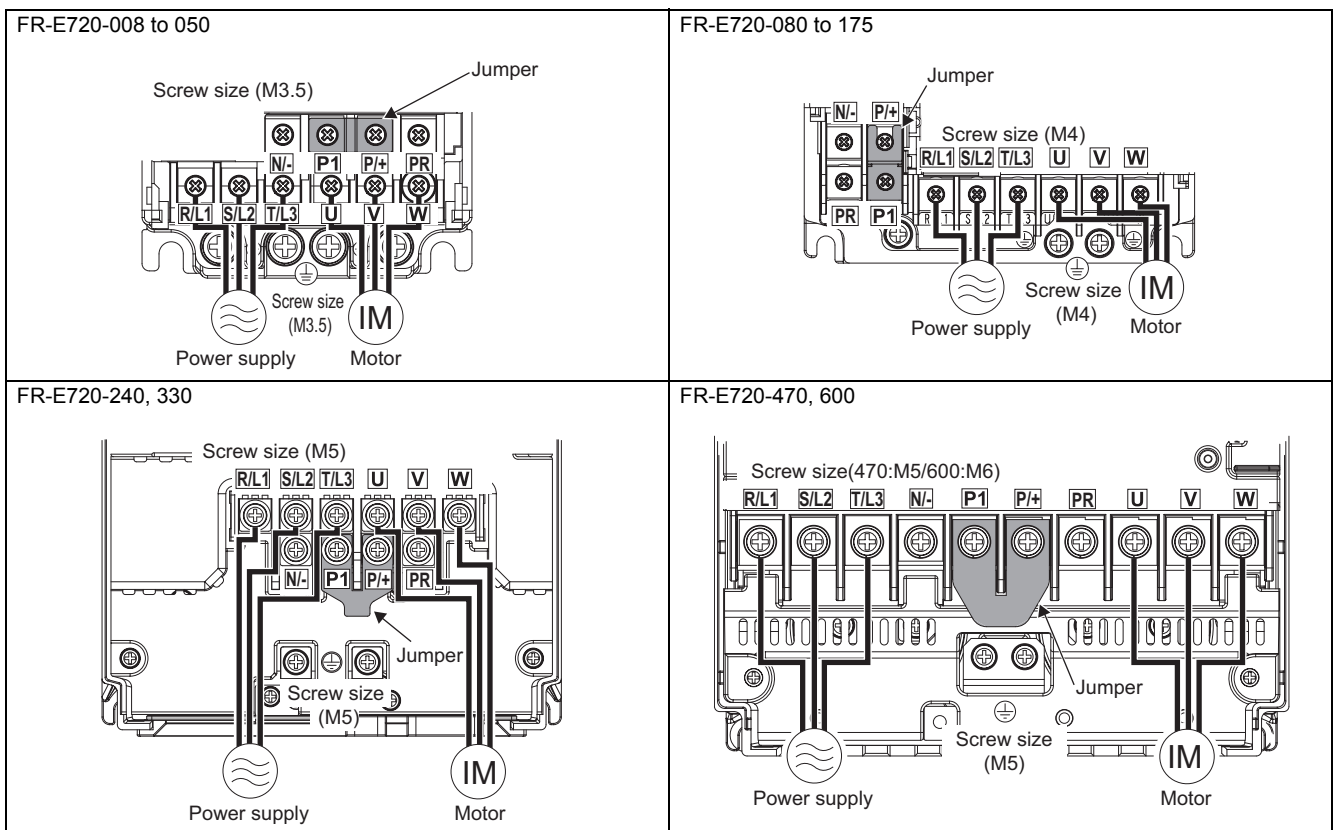

## 7 Main circuit terminal specifications

### 400V class

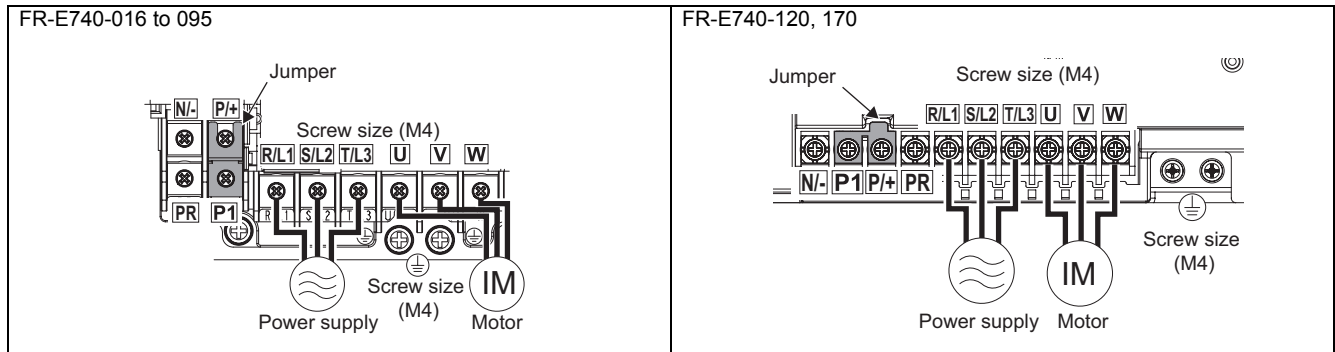

#### NOTE

- Make sure the power cables are connected to the R/L1, S/L2, T/L3. Never connect the power cable to the U, V, W of the inverter. Doing so will damage the inverter. (Phase need not be matched.)
- Connect the motor to U, V, W. Turning on the forward rotation switch (signal) at this time rotates the motor counterclockwise when viewed from the load shaft.

### 2.2.3 Cables and wiring length

#### (1) Applied wire size

Select the recommended cable size to ensure that a voltage drop will be 2% max.

If the wiring distance is long between the inverter and motor, a main circuit cable voltage drop will cause the motor torque to decrease especially at the output of a low frequency.

The following table indicates a selection example for the wiring length of 20m (65.61feet).

#### 200V class (when input power supply is 220V)

Applicable Inverter Model	Terminal Screw Size *4	Tightening Torque N·m	Crimping Terminal		Cable Size							
					HIV Cables, etc. (mm <sup>2</sup> ) *1			AWG *2		PVC Cables, etc. (mm <sup>2</sup> ) *3		
					R/L1 S/L2 T/L3	U, V, W	R/L1 S/L2 T/L3	U, V, W	Earth (ground) cable	R/L1 S/L2 T/L3	U, V, W	R/L1 S/L2 T/L3
FR-E720-008 to 050	M3.5	1.2	2-3.5	2-3.5	2	2	2	14	14	2.5	2.5	2.5
FR-E720-080, 110	M4	1.5	2-4	2-4	2	2	2	14	14	2.5	2.5	2.5
FR-E720-175	M4	1.5	5.5-4	5.5-4	3.5	3.5	3.5	12	12	4	4	4
FR-E720-240	M5	2.5	5.5-5	5.5-5	5.5	5.5	5.5	10	10	6	6	6
FR-E720-330	M5	2.5	14-5	8-5	14	8	5.5	6	8	16	10	6
FR-E720-470	M5	2.5	14-5	14-5	14	14	14	6	6	16	16	16
FR-E720-600	M6(M5)	4.4	22-6	22-6	22	22	14	4	4	25	25	16

#### 400V class (when input power supply is 440V)

Applicable Inverter Model	Terminal Screw Size *4	Tightening Torque N·m	Crimping Terminal		Cable Size							
					HIV Cables, etc. (mm <sup>2</sup> ) *1			AWG *2		PVC Cables, etc. (mm <sup>2</sup> ) *3		
					R/L1 S/L2 T/L3	U, V, W	R/L1 S/L2 T/L3	U, V, W	Earth (ground) cable	R/L1 S/L2 T/L3	U, V, W	R/L1 S/L2 T/L3
FR-E740-016 to 095	M4	1.5	2-4	2-4	2	2	2	14	14	2.5	2.5	2.5
FR-E740-120	M4	1.5	5.5-4	2-4	3.5	2	3.5	12	14	4	2.5	4
FR-E740-170	M4	1.5	5.5-4	5.5-4	3.5	3.5	3.5	12	12	4	4	4

- \*1 The cable size is that of the cable (HIV cable (600V class 2 vinyl-insulated cable) etc.) with continuous maximum permissible temperature of 75°C (167°F). Assumes that the ambient temperature is 50°C (122°F) or less and the wiring distance is 20m (65.61feet) or less.
- \*2 The recommended cable size is that of the cable (THHW cable) with continuous maximum permissible temperature of 75°C (167°F). Assumes that the ambient temperature is 40°C (104°F) or less and the wiring distance is 20m (65.61feet) or less. (Selection example for use mainly in the United States.)
- \*3 The recommended cable size is that of the cable (THHW cable) with continuous maximum permissible temperature of 70°C (158°F). Assumes that the ambient temperature is 40°C (104°F) or less and the wiring distance is 20m (65.61feet) or less. (Selection example for use mainly in Europe.)
- \*4 The terminal screw size indicates the terminal size for R/L1, S/L2, T/L3, U, V, W, and a screw for earthing (grounding). A screw for earthing (grounding) of the FR-E720-600 is indicated in ( ).



#### NOTE

- Tighten the terminal screw to the specified torque. A screw that has been tighten too loosely can cause a short circuit or malfunction. A screw that has been tighten too tightly can cause a short circuit or malfunction due to the unit breakage.
- Use crimping terminals with insulation sleeve to wire the power supply and motor.

The line voltage drop can be calculated by the following formula:

$$\text{line voltage drop [V]} = \frac{\sqrt{3} \times \text{wire resistance [m}\Omega\text{/m]} \times \text{wiring distance [m]} \times \text{current [A]}}{1000}$$

Use a larger diameter cable when the wiring distance is long or when it is desired to decrease the voltage drop (torque reduction) in the low speed range.

### (2) Earthing (Grounding) precautions

- Always earth (ground) the motor and inverter.

#### 1) Purpose of earthing (grounding)

Generally, an electrical apparatus has an earth (ground) terminal, which must be connected to the ground before use. An electrical circuit is usually insulated by an insulating material and encased. However, it is impossible to manufacture an insulating material that can shut off a leakage current completely, and actually, a slight current flow into the case. The purpose of earthing (grounding) the case of an electrical apparatus is to prevent operator from getting an electric shock from this leakage current when touching it.

To avoid the influence of external noises, this earthing (grounding) is important to audio equipment, sensors, computers and other apparatuses that handle low-level signals or operate very fast.

#### 2) Earthing (grounding) methods and earthing (grounding) work

As described previously, earthing (grounding) is roughly classified into an electrical shock prevention type and a noise-affected malfunction prevention type. Therefore, these two types should be discriminated clearly, and the following work must be done to prevent the leakage current having the inverter's high frequency components from entering the malfunction prevention type earthing (grounding):

(a) Where possible, use independent earthing (grounding) for the inverter. If independent earthing (grounding) (I) is impossible, use joint earthing (grounding) (II) where the inverter is connected with the other equipment at an earthing (grounding) point. Joint earthing (grounding) as in (III) must be avoided as the inverter is connected with the other equipment by a common earth (ground) cable.

Also a leakage current including many high frequency components flows in the earth (ground) cables of the inverter and inverter-driven motor. Therefore, they must use the independent earthing (grounding) method and be separated from the earthing (grounding) of equipment sensitive to the aforementioned noises.

In a tall building, it will be a good policy to use the noise malfunction prevention type earthing (grounding) with steel frames and carry out electric shock prevention type earthing (grounding) in the independent earthing (grounding) method.

(b) This inverter must be earthed (grounded). Earthing (Grounding) must conform to the requirements of national and local safety regulations and electrical codes. (NEC section 250, IEC 536 class 1 and other applicable standards).

(c) Use the thickest possible earth (ground) cable. The earth (ground) cable should be of not less than the size indicated in the table on the previous *page 17*.

(d) The grounding point should be as near as possible to the inverter, and the ground wire length should be as short as possible.

(e) Run the earth (ground) cable as far away as possible from the I/O wiring of equipment sensitive to noises and run them in parallel in the minimum distance.

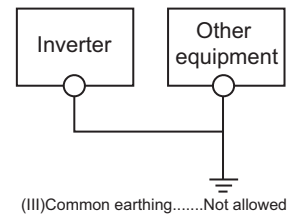
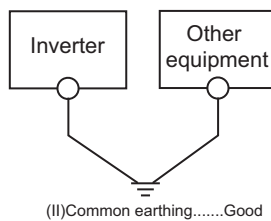
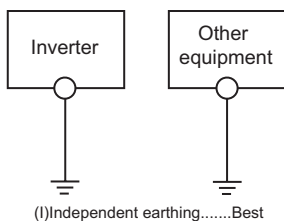

#### POINT

To be compliant with the European Directive (Low Voltage Directive),  refer to the *Installation Guideline*.

**(3) Total wiring length**

The overall wiring length for connection of a single motor or multiple motors should be within the value in the table below.

200V class

Pr. 72 PWM frequency selection Setting (carrier frequency)	008	015	030	050	080	110	175 or More
1 (1kHz) or less	200m (656.19feet)	200m (656.19feet)	300m (984.25feet)	500m (1640.42feet)	500m (1640.42feet)	500m (1640.42feet)	500m (1640.42feet)
2 to15 (2kHz to 14.5kHz)	30m (98.42feet)	100m (328.08feet)	200m (656.19feet)	300m (984.25feet)	500m (1640.42feet)	500m (1640.42feet)	500m (1640.42feet)

400V class

Pr. 72 PWM frequency selection Setting (carrier frequency)	016	026	040	060	095 or More
1 (1kHz) or less	200m (656.19feet)	200m (656.19feet)	300m (984.25feet)	500m (1640.42feet)	500m (1640.42feet)
2 to15 (2kHz to 14.5kHz)	30m (98.42feet)	100m (328.08feet)	200m (656.19feet)	300m (984.25feet)	500m (1640.42feet)

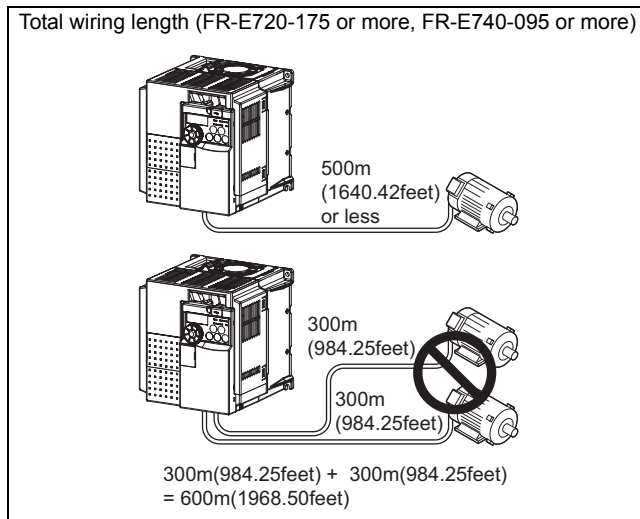

When driving a 400V class motor by the inverter, surge voltages attributable to the wiring constants may occur at the motor terminals, deteriorating the insulation of the motor. (Refer to page 89)



**NOTE**

- Especially for long-distance wiring, the inverter may be affected by a charging current caused by the stray capacitances of the wiring, leading to a malfunction of the overcurrent protective function, fast response current limit function, or stall prevention function or a malfunction or fault of the equipment connected on the inverter output side. If fast-response current limit malfunctions, disable this function. When the stall prevention function misoperates, increase the stall level. (Refer to page 85 for Pr. 22 Stall prevention operation level and Pr. 156 Stall prevention operation selection)
- Refer to page 166 for details of Pr. 72 PWM frequency selection. Refer to the manual of the option for details of surge voltage suppression filter (FR-ASF-H/FR-BMF-H).
- When using the automatic restart after instantaneous power failure function with wiring length exceeding below, select without frequency search (Pr. 162 = "1, 11"). ( Refer to page 154)

Motor capacity (kW(HP))	0.1K(1/8)	0.2K(1/4)	0.4K(1/2) or more
Wiring length	20m (65.61feet)	50m (164.04feet)	100m (323.08feet)

## 2.3 Control circuit specifications

### 2.3.1 Standard control circuit terminal

□ indicates that terminal functions can be selected using *Pr. 178 to Pr. 184, Pr. 190 to Pr. 192 (I/O terminal function selection)*. (Refer to page 131).

#### (1) Input signal

Type	Terminal Symbol	Terminal Name	Description		Rated Specifications	Refer to Page	
Contact input	STF	Forward rotation start	Turn on the STF signal to start forward rotation and turn it off to stop.	When the STF and STR signals are turned on simultaneously, the stop command is given.	Input resistance 4.7kΩ Voltage when contacts are open 21 to 26VDC When contacts are short-circuited 4 to 6mADC	135	
	STR	Reverse rotation start	Turn on the STR signal to start reverse rotation and turn it off to stop.				
	RH, RM, RL	Multi-speed selection	Multi-speed can be selected according to the combination of RH, RM and RL signals.			95	
	MRS	Output stop	Turn on the MRS signal (20ms or more) to stop the inverter output. Use to shut off the inverter output when stopping the motor by electromagnetic brake.				133
	RES	Reset	Used to reset fault output provided when fault occurs. Turn on the RES signal for more than 0.1s, then turn it off. Factory setting is for reset always. By setting <i>Pr. 75</i> , reset can be set to enabled only at fault occurrence. Recover about 1s after reset is cancelled.				
	SD	Contact input common (sink) (initial setting)	Common terminal for contact input terminal (sink logic).				—
		External transistor common (source)	When connecting the transistor output (open collector output), such as a programmable controller, when source logic is selected, connect the external power supply common for transistor output to this terminal to prevent a malfunction caused by undesirable currents.				
		24VDC power supply common	Common output terminal for 24VDC 0.1A power supply (PC terminal). Isolated from terminals 5 and SE.				
	PC	External transistor common (sink) (initial setting)	When connecting the transistor output (open collector output), such as a programmable controller, when sink logic is selected, connect the external power supply common for transistor output to this terminal to prevent a malfunction caused by undesirable currents.		Power supply voltage range 22 to 26VDC permissible load current 100mA	24	
		Contact input common (source)	Common terminal for contact input terminal (source logic).				
24VDC power supply		Can be used as 24VDC 0.1A power supply.					

Type	Terminal Symbol	Terminal Name	Description	Rated Specifications	Refer to Page
Frequency setting	10	Frequency setting power supply	Used as power supply when connecting potentiometer for frequency setting (speed setting) from outside of the inverter. (Refer to Pr.73 Analog input selection.)	5.2V ± 0.2VDC permissible load current 10mA	168
	2	Frequency setting (voltage)	Inputting 0 to 5VDC (or 0 to 10V) provides the maximum output frequency at 5V (10V) and makes input and output proportional. Use Pr. 73 to switch between input 0 to 5VDC input (initial setting) and 0 to 10VDC.	Input resistance 10kΩ ± 1kΩ Permissible maximum voltage 20VDC	168
	4	Frequency setting (current)	Inputting 4 to 20mADC (or 0 to 5V, 0 to 10V) provides the maximum output frequency at 20mA and makes input and output proportional. This input signal is valid only when the AU signal is on (terminal 2 input is invalid). Use Pr. 267 to switch from among input 4 to 20mA (initial setting), 0 to 5VDC and 0 to 10VDC. Set the voltage/current input switch in the "V" position to select voltage input (0 to 5V/0 to 10V).	Current input: Input resistance 233Ω ± 5Ω Maximum permissible current 30mA Voltage input: Input resistance 10kΩ ± 1kΩ Permissible maximum voltage 20VDC  Current input (initial status) Voltage input 	168
	5	Frequency setting common	Common terminal for frequency setting signal (terminal 2, 1 or 4) and analog output terminal AM. Do not earth (ground).	—	—



**NOTE**

Set Pr. 267 and a voltage/current input switch correctly, then input analog signals in accordance with the settings. Applying a voltage with voltage/current input switch in "I" position (current input is selected) or a current with switch in "V" position (voltage input is selected) could cause component damage of the inverter or analog circuit of output devices. Refer to page 168 for details.



### (2) Output signal

Type	Terminal Symbol	Terminal Name	Description	Rated Specifications	Reference Page	
Relay	A, B, C	Relay output (fault output)	1 changeover contact output indicates that the inverter protective function has activated and the output stopped. Fault: discontinuity across B-C (continuity across A-C), Normal: continuity across B-C (discontinuity across A-C)	Contact capacity: 230VAC 0.3A (power factor = 0.4) 30VDC 0.3A	137	
Open collector	RUN	Inverter running	Switched low when the inverter output frequency is equal to or higher than the starting frequency (initial value 0.5Hz). Switched high during stop or DC injection brake operation. *1	Permissible load 24VDC (maximum 27VDC) 0.1A (a voltage drop is 3.4V maximum when the signal is on)	137	
	FU	Frequency detection	Switched low when the inverter output frequency is equal to or higher than the preset detected frequency and high when less than the preset detected frequency. *1		141	
	SE	Open collector output common	Common terminal of terminal RUN and FU.	—	—	
Analog	AM	Analog signal output	Select one e.g. output frequency from monitor items. *2 The output signal is proportional to the magnitude of the corresponding monitoring item.	Output item: Output frequency (initial setting)	Output signal 0 to 10VDC Permissible load current 1mA (load impedance 10kΩ or more) Resolution 8 bit	146

\*1 Low indicates that the open collector output transistor is on (conducts).  
High indicates that the transistor is off (does not conduct).

\*2 Not output during inverter reset.

### (3) Communication

Type	Terminal Symbol	Terminal Name	Description	Reference Page
RS-485	—	PU connector	With the PU connector, communication can be made through RS-485. <ul style="list-style-type: none"> <li>• Conforming standard: EIA-485 (RS-485)</li> <li>• Transmission format: Multidrop link</li> <li>• Communication speed: 4800 to 38400bps</li> <li>• Overall length: 500m (1640.42feet)</li> </ul>	200
USB	—	USB connector	The FR Configurator can be operated by connecting the inverter to the personnel computer through USB. <ul style="list-style-type: none"> <li>• Interface: conforms to USB1.1</li> <li>• Transmission speed: 12Mbps</li> <li>• Connector: USB mini B connector (receptacle mini B type)</li> </ul>	233

### 2.3.2 Changing the control logic

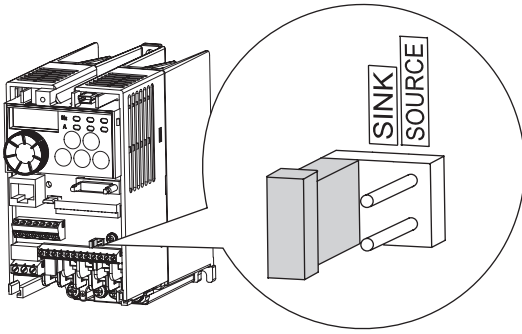

The input signals are set to sink logic (SINK) when shipped from the factory.

To change the control logic, the jumper connector above the control terminal must be moved to the other position.

- To change to source logic, change the jumper connector in the sink logic (SINK) position to source logic (SOURCE) position using tweezers, a pair of long-nose pliers etc. Change the jumper connector position before switching power on.



#### NOTE

- Fully make sure that the front cover has been reinstalled securely.
- The capacity plate is placed on the front cover and the rating plate is on the inverter. Since these plates have the same serial numbers, always reinstall the removed cover onto the original inverter.
- The sink-source logic change-over jumper connector must be fitted in only one of those positions. If it is fitted in both positions at the same time, the inverter may be damaged.

## Control circuit specifications

### (1) Sink logic type and source logic type

- In sink logic, a signal switches on when a current flows from the corresponding signal input terminal. Terminal SD is common to the contact input signals. Terminal SE is common to the open collector output signals.
- In source logic, a signal switches on when a current flows into the corresponding signal input terminal. Terminal PC is common to the contact input signals. Terminal SE is common to the open collector output signals.

● Current flow concerning the input/output signal when sink logic is selected

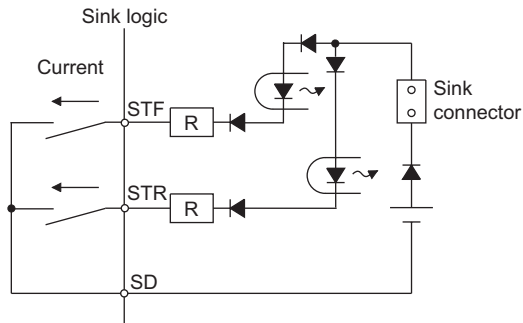

● Current flow concerning the input/output signal when source logic is selected

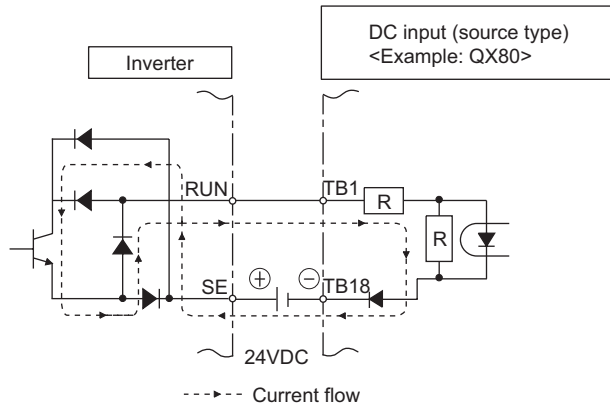
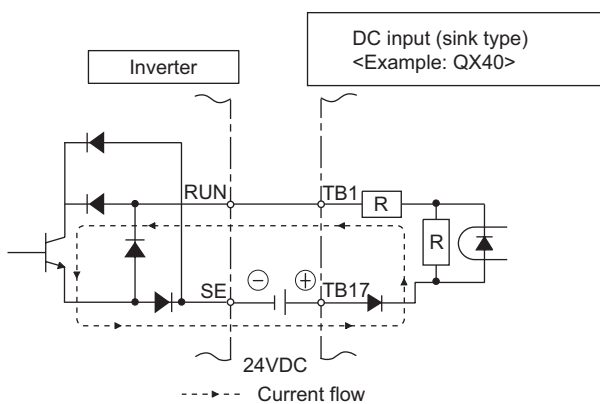
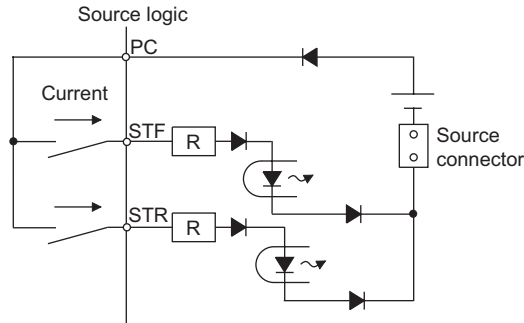

● When using an external power supply for transistor output

#### • Sink logic type

Use terminal PC as a common terminal, and perform wiring as shown below. (Do not connect terminal SD of the inverter with terminal 0V of the external power supply. When using terminals PC-SD as a 24VDC power supply, do not install an external power supply in parallel with the inverter. Doing so may cause a malfunction in the inverter due to undesirable currents.)

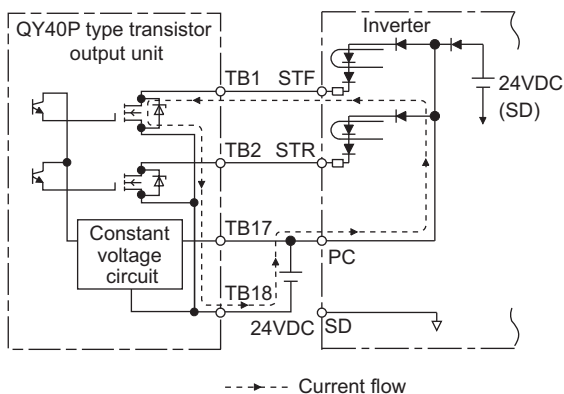

#### • Source logic type

Use terminal SD as a common terminal, and perform wiring as shown below. (Do not connect terminal PC of the inverter with terminal +24V of the external power supply. When using terminals PC-SD as a 24VDC power supply, do not install an external power supply in parallel with the inverter. Doing so may cause a malfunction in the inverter due to undesirable currents.)

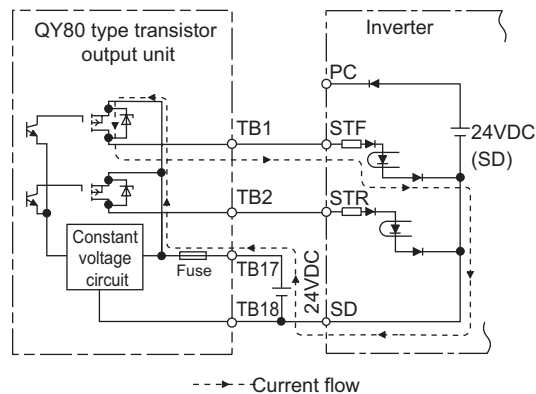

### 2.3.3 Wiring of control circuit

#### (1) Standard control circuit terminal layout

Terminal screw size  
 M3: (Terminal A, B, C)  
 M2: (Other than the above)

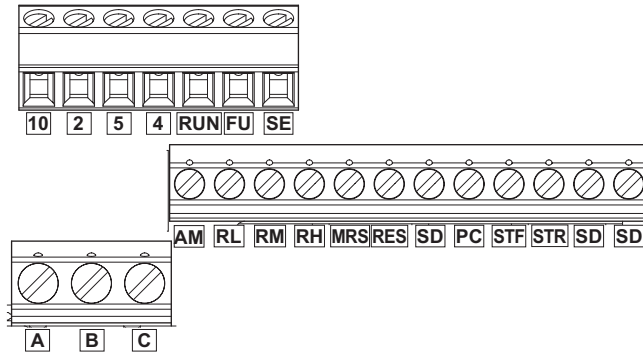

#### (2) Wiring method

1) Strip off the sheath of the cable of the control circuit to wire.

Strip off the sheath about the size below. If the length of the sheath peeled is too long, a short circuit may occur among neighboring wires. If the length is too short, wires might come off.

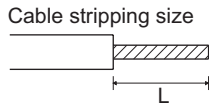

**Wire the stripped cable after twisting it to prevent it from becoming loose. In addition, do not solder it. Use a bar terminal as necessary.**

	L(mm)
Terminal A, B, C	6
Other than the above	5

Introduced products on bar terminals

Terminal Screw Size	Wire Size (mm <sup>2</sup> )	Bar Terminal Model		Maker
		With Insulation Sleeve	Without Insulation Sleeve	
M3 (terminal A, B, C)	0.3 to 0.5	AI 0,5-6WH	A 0,5-6	Phoenix Contact Co.,Ltd.
	0.5 to 0.75	AI 0,75-6GY	A 0,75-6	
M2 (other than the above)	0.3 to 0.5	AI 0,5-6WH	A 0,5-6	

Bar terminal crimping tool: CRIMPFOX ZA3 (Phoenix Contact Co., Ltd.)

2) Loosen the terminal screw and insert the cable into the terminal.

3) Tighten the screw to the specified torque.

Undertightening can cause cable disconnection or malfunction. Overtightening can cause a short circuit or malfunction due to damage to the screw or unit.

Tightening torque: 0.5N·m to 0.6N·m (terminal A, B, C)

0.22N·m to 0.25N·m (other than the above)

\* Screwdriver: ⊖ Small flat-blade screwdriver (Tip thickness: 0.4mm/tip width: 2.5mm)

#### (3) Control circuit common terminals (SD, 5, SE)

Terminals SD, SE and 5 are common terminals for I/O signals.(All common terminals are isolated from each other.) Do not earth them. Avoid connecting the terminal SD and 5 and the terminal SE and 5.

Terminal SD is a common terminal for the contact input terminals (STF, STR, RH, RM, RL, MRS, RES). The open collector circuit is isolated from the internal control circuit by photocoupler

Terminal 5 is a common terminal for the frequency setting signals (terminals 2 or 4) and analog signal output (AM). It should be protected from external noise using a shielded or twisted cable.

Terminal SE is a common terminal for the open collector output terminal (RUN, FU). The contact input circuit is isolated from the internal control circuit by photocoupler

### (4) Signal inputs by contactless switches

The contacted input terminals of the inverter (STF, STR, RH, RM, RL, MRS, RES) can be controlled using a transistor instead of a contacted switch as shown on the right.

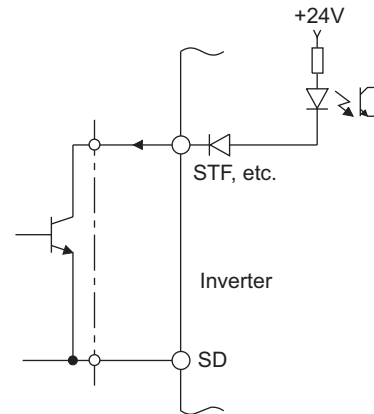

External signal input using transistor

### 2.3.4 Wiring instructions

- 1) Use shielded or twisted cables for connection to the control circuit terminals and run them away from the main and power circuits (including the 200V relay sequence circuit).
- 2) Use two or more parallel micro-signal contacts or twin contacts to prevent contact faults when using contact inputs since the control circuit input signals are micro-currents.

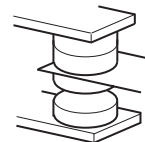

Micro signal contacts

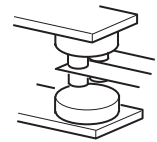

Twin contacts

- 3) Do not apply a voltage to the contact input terminals (e.g. STF) of the control circuit.
- 4) Always apply a voltage to the fault output terminals (A, B, C) via a relay coil, lamp, etc.
- 5) It is recommended to use the cables of  $0.3\text{mm}^2$  to  $0.75\text{mm}^2$  gauge for connection to the control circuit terminals.  
If the cable gauge used is  $1.25\text{mm}^2$  or more, the front cover may be lifted when there are many cables running or the cables are run improperly, resulting in an operation panel contact fault.
- 6) The maximum wiring length should be 30m (98.43feet).

### 2.3.5 Connection to the PU connector

Using the PU connector, you can perform communication operation from the FR-PU07, a personal computer etc. Refer to the figure below to open the PU connector cover.

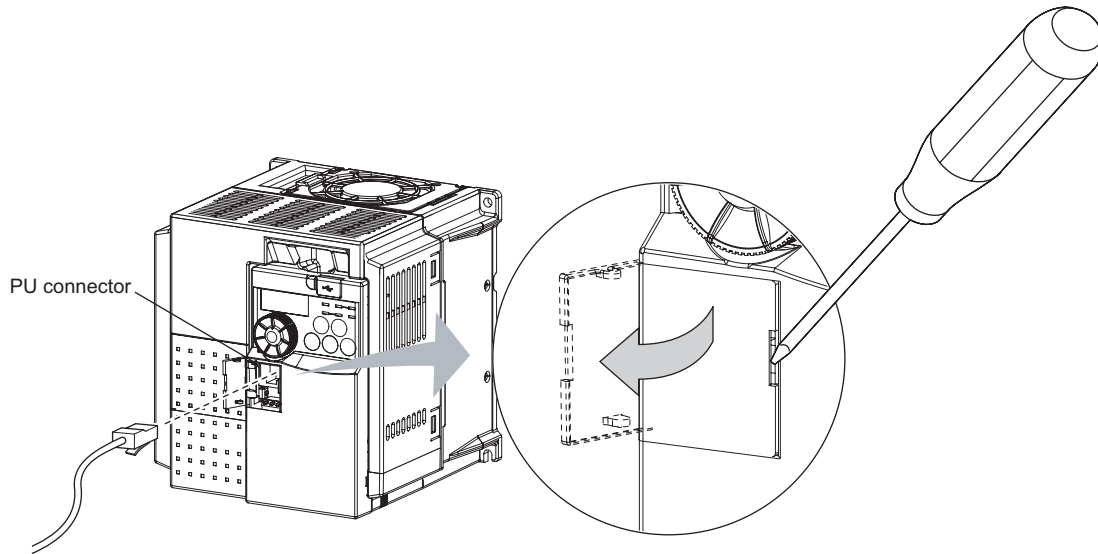

#### To open the cover

Place a flat-blade screwdriver, etc. in a slot and push up the cover to open.

#### ●When connecting the parameter unit using a connection cable

Use the optional FR-CB2□□ or connector and cable available on the market.

Insert the cable plugs securely into the PU connector of the inverter and the connection connector of the FR-PU07 along the guide until the tabs snap into place.

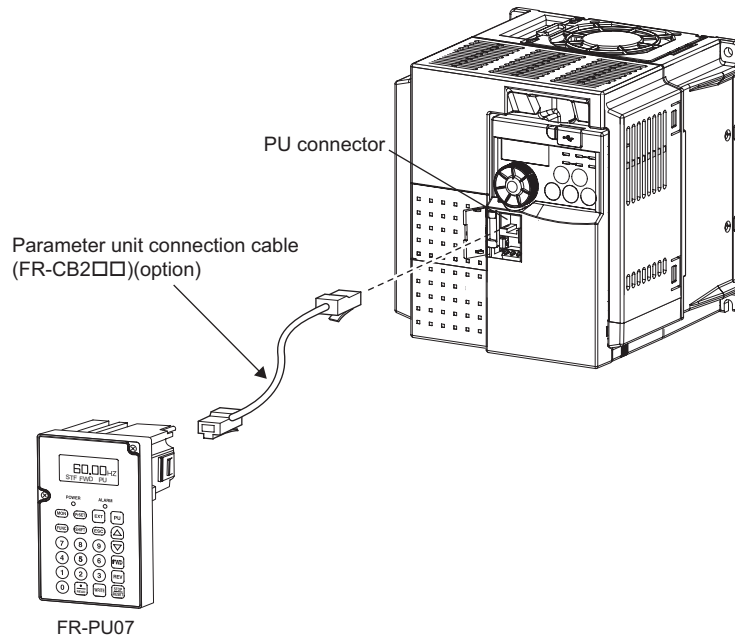

#### REMARKS

- Overall wiring length when the parameter unit is connected: max 20m (65.6feet)
- Refer to the following when fabricating the cable on the user side.

Examples of product available on the market (as of September, 2006)

	Product	Type	Maker
1)	10BASE-T cable	SGLPEV-T 0.5mm × 4P	Mitsubishi Cable Industries, Ltd.

### ●RS-485 communication

When the PU connector is connected with a personal, FA or other computer by a communication cable, a user program can run and monitor the inverter or read and write to parameters.

The protocol can be selected from Mitsubishi inverter and Modbus RTU.

#### • PU connector pin-outs

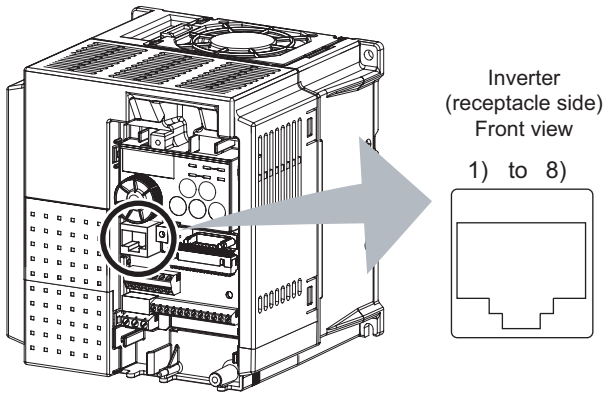

Pin Number	Name	Description
1)	SG	Earth (ground) (connected to terminal 5)
2)	—	Parameter unit power supply
3)	RDA	Inverter receive+
4)	SDB	Inverter send-
5)	SDA	Inverter send+
6)	RDB	Inverter receive-
7)	SG	Earth (ground) (connected to terminal 5)
8)	—	Parameter unit power supply



#### NOTE

- Pins No. 2 and 8 provide power to the operation panel or parameter unit. Do not use these pins for RS-485 communication.
- When making RS-485 communication between the FR-E700 series, FR-E500 series and FR-S500 series, incorrect connection of pins No.2 and 8 (parameter unit power supply) of the above PU connector may result in the inverter malfunction or failure.
- Do not connect the PU connector to the computer's LAN board, FAX modem socket or telephone modular connector. The product could be damaged due to differences in electrical specifications.

For further details, refer to page 200.

- Conforming standard: EIA-485 (RS-485)
- Transmission form: Multidrop link
- Communication speed: Maximum 38400 bps
- Overall extension: 500m (1640feet)

## 2.4 Connection of stand-alone option unit

The inverter accepts a variety of stand-alone option units as required.

Incorrect connection will cause inverter damage or accident. Connect and operate the option unit carefully in accordance with the corresponding option unit manual.

### 2.4.1 Connection of a dedicated external brake resistor (MRS type, MYS type, FR-ABR) (FR-E720-030 or more, FR-E740-016 or more)

Install a dedicated brake resistor (MRS type, MYS type, FR-ABR) outside when the motor is made to run by the load, quick deceleration is required, etc. Connect a dedicated brake resistor (MRS type, MYS type, FR-ABR) to terminal P/+ and PR. (For the locations of terminal P/+ and PR, refer to the terminal block layout (page 15).)

Set parameters below.

Connected Brake Resistor	Pr. 30 Regenerative function selection Setting	Pr. 70 Special regenerative brake duty Setting		
		MRS type, MYS type	0 (initial value)	—
FR-ABR	1	FR-E720-330 or less	10%	
		FR-E740-170 or less	6%	



#### NOTE

The brake resistor connected should only be the dedicated brake resistor.

<b>FR-E720-030, 050</b> Connect the brake resistor across terminals P/+ and PR. 	<b>FR-E720-080 to 175</b> <b>FR-E740-016 to 095</b> Connect the brake resistor across terminals P/+ and PR. 
<b>FR-E720-240 to 600</b> Connect the brake resistor across terminals P/+ and PR. 	<b>FR-E740-120, 170</b> Connect the brake resistor across terminals P/+ and PR. 

\* Do not remove a jumper across terminal P/+ and P1 except when connecting a DC reactor.



## (1) When using the brake resistor (MRS, MYS) and high-duty brake resistor (FR-ABR)

- It is recommended to configure a sequence, which shuts off power in the input side of the inverter by the external thermal relay as shown below, to prevent overheat and burnout of the brake resistor (MRS, MYS) and high duty brake resistor (FR-ABR) in case the regenerative brake transistor is damaged. (The brake resistor can not be connected to the FR-E720-008 or 015.)

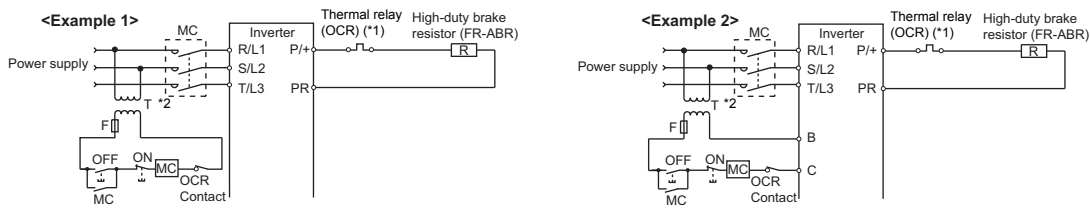

\*1 Refer to the table below for the type number of each capacity of thermal relay and the diagram below for the connection.

(Always install a thermal relay when using a brake resistor whose capacity is FR-E720-470 or more)

\*2 When the power supply is 400V class, install a step-down transformer.

Power Supply Voltage	Brake Resistor	Thermal Relay Type (Mitsubishi product)	Contact Rating
200V	MRS120W200	TH-N20CXHZ-0.7A	110VAC 5A, 220VAC 2A(AC11 class) 110VDC 0.5A, 220VDC 0.25A(DC11class)
	MRS120W100	TH-N20CXHZ-1.3A	
	MRS120W60	TH-N20CXHZ-2.1A	
	MRS120W40	TH-N20CXHZ-3.6A	
	MYS220W50 (two units in parallel)	TH-N20CXHZ-5A	

Power Supply Voltage	High-duty Brake Resistor	Thermal Relay Type (Mitsubishi product)	Contact Rating
200V	FR-ABR-0.4K	TH-N20CXHZ-0.7A	110VAC 5A, 220VAC 2A(AC11 class) 110VDC 0.5A, 220VDC 0.25A(DC11 class)
	FR-ABR-0.75K	TH-N20CXHZ-1.3A	
	FR-ABR-2.2K	TH-N20CXHZ-2.1A	
	FR-ABR-3.7K	TH-N20CXHZ-3.6A	
	FR-ABR-5.5K	TH-N20CXHZ-5A	
	FR-ABR-7.5K	TH-N20CXHZ-6.6A	
	FR-ABR-11K	TH-N20CXHZ-11A	
400V	FR-ABR-H0.4K	TH-N20CXHZ-0.24A	110VAC 5A, 220VAC 2A(AC11 class) 110VDC 0.5A, 220VDC 0.25A(DC11 class)
	FR-ABR-H0.75K	TH-N20CXHZ-0.35A	
	FR-ABR-H1.5K	TH-N20CXHZ-0.9A	
	FR-ABR-H2.2K	TH-N20CXHZ-1.3A	
	FR-ABR-H3.7K	TH-N20CXHZ-2.1A	
	FR-ABR-H5.5K	TH-N20CXHZ-2.5A	
	FR-ABR-H7.5K	TH-N20CXHZ-3.6A	

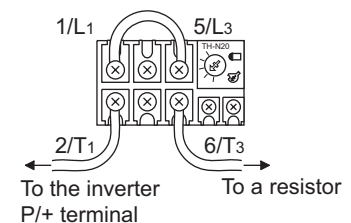

### NOTE

- Brake resistor can not be used with the brake unit, high power factor converter, power supply regeneration converter, etc.
- Do not use the brake resistor with a lead wire extended.
- Do not connect a resistor directly to the DC terminals P/+ and N/-. This could cause a fire.

### 2.4.2 Connection of the brake unit (FR-BU2)

Connect the brake unit (FR-BU2(-H)) as shown below to improve the braking capability at deceleration. If the transistors in the brake unit should become faulty, the resistor can be unusually hot. To prevent unusual overheat and fire, install a magnetic contactor on the inverter's input side to configure a circuit so that a current is shut off in case of fault.

#### (1) Connection example with the GRZG type discharging resistor

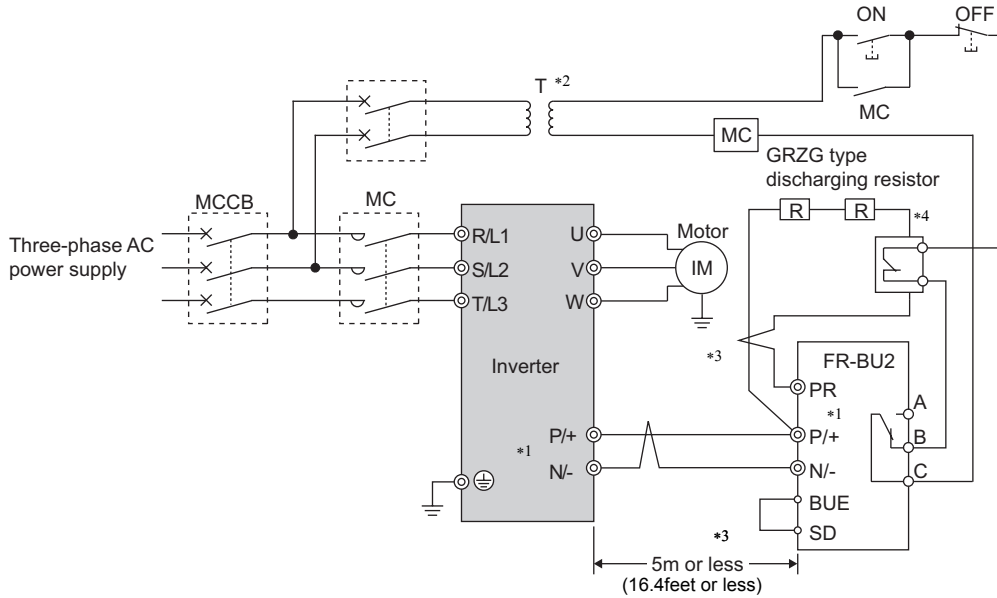

- \*1 Connect the inverter terminals (P/+, N/-) and brake unit (FR-BU2) terminals so that their terminal names match with each other.  
(Incorrect connection will damage the inverter and brake unit.)
- \*2 When the power supply is 400V class, install a step-down transformer.
- \*3 The wiring distance between the inverter, brake unit (FR-BU2) and discharging resistor should be within 5m. Even when the wiring is twisted, the cable length must not exceed 10m.
- \*4 It is recommended to install an external thermal relay to prevent overheat of brake resistors.

<Recommended external thermal relay>

Brake Unit	Discharging Resistor	Recommended External Thermal Relay
FR-BU2-1.5K	GZG 300W-50Ω	TH-N20CXHZ 1.3A
FR-BU2-3.7K	GRZG 200-10Ω	TH-N20CXHZ 3.6A
FR-BU2-7.5K	GRZG 300-5Ω	TH-N20CXHZ 6.6A
FR-BU2-15K	GRZG 400-2Ω	TH-N20CXHZ 1.1A
FR-BU2-H7.5K	GRZG 200-10Ω	TH-N20CXHZ 3.6A



#### NOTE

- Set "1" in Pr. 0 Brake mode selection of the FR-BU2 to use GRZG type discharging resistor.
- Do not remove a jumper across terminal P/+ and P1 except when connecting a DC reactor.

## (2) Connection example with the FR-BR(-H) type resistor

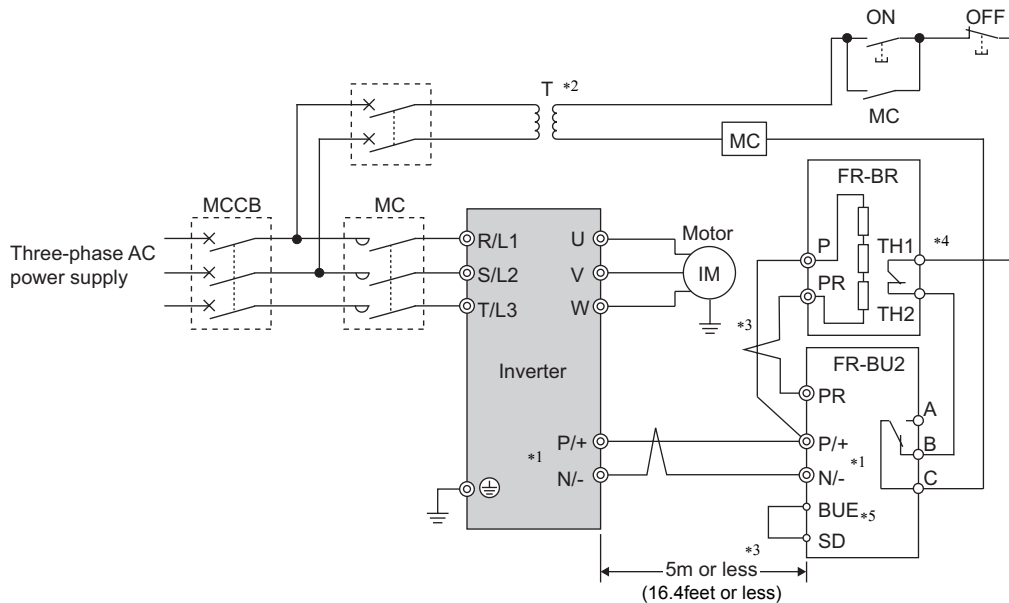

- \*1 Connect the inverter terminals (P/+, N/-) and brake unit (FR-BU2) terminals so that their terminal names match with each other.  
(Incorrect connection will damage the inverter and brake unit.)
- \*2 When the power supply is 400V class, install a step-down transformer.
- \*3 The wiring distance between the inverter, brake unit (FR-BU2) and resistor unit (FR-BR) should be within 5m(16.4feet). Even when the wiring is twisted, the cable length must not exceed 10m(32.8feet).
- \*4 Normal: across TH1-TH2...close, Alarm: across TH1-TH2...open
- \*5 A jumper is connected across BUE and SD in the initial status.



### NOTE

- Do not remove a jumper across terminal P/+ and P1 except when connecting a DC reactor.

## 2.4.3 Connection of the high power factor converter (FR-HC)

When connecting the high power factor converter (FR-HC) to suppress power harmonics, perform wiring securely as shown below. Incorrect connection will damage the high power factor converter and inverter.

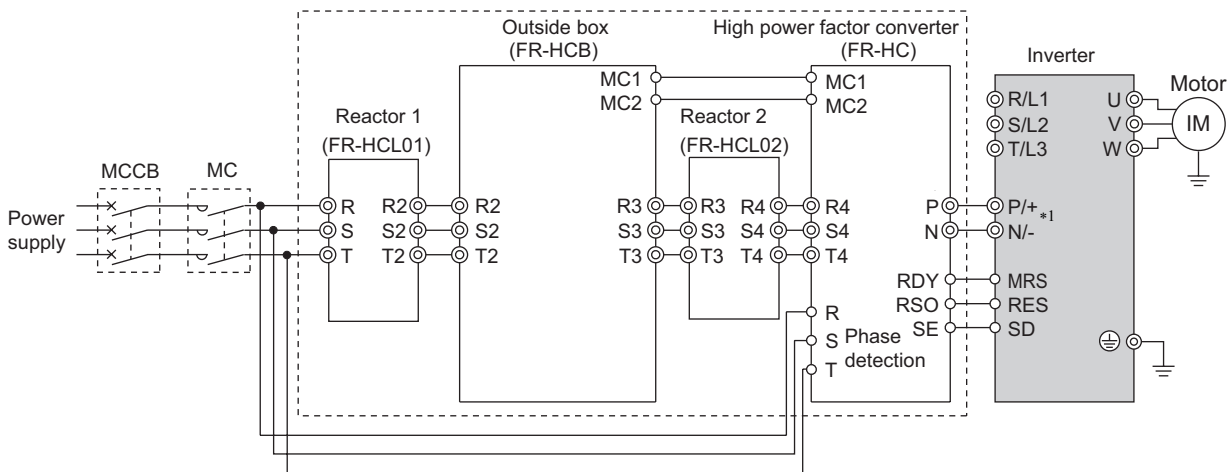

- \*1 Do not insert an MCCB between the terminals P/+ and N/- (between P-P/+, between N-N/-). Opposite polarity of terminals N/-, P/+ will damage the inverter.



### NOTE

- The voltage phases of terminals R/L1, S/L2, T/L3 and terminals R4, S4, T4 must be matched.
- Use sink logic (factory setting) when the FR-HC is connected. The FR-HC cannot be connected when source logic is selected.
- Do not remove a jumper across terminal P/+ and P1 except when connecting a DC reactor.

### 2.4.4 Connection of the power regeneration common converter (FR-CV)

When connecting the power regeneration common converter (FR-CV), connect the inverter terminals (P/+, N/-) and power regeneration common converter (FR-CV) terminals as shown below so that their symbols match with each other.

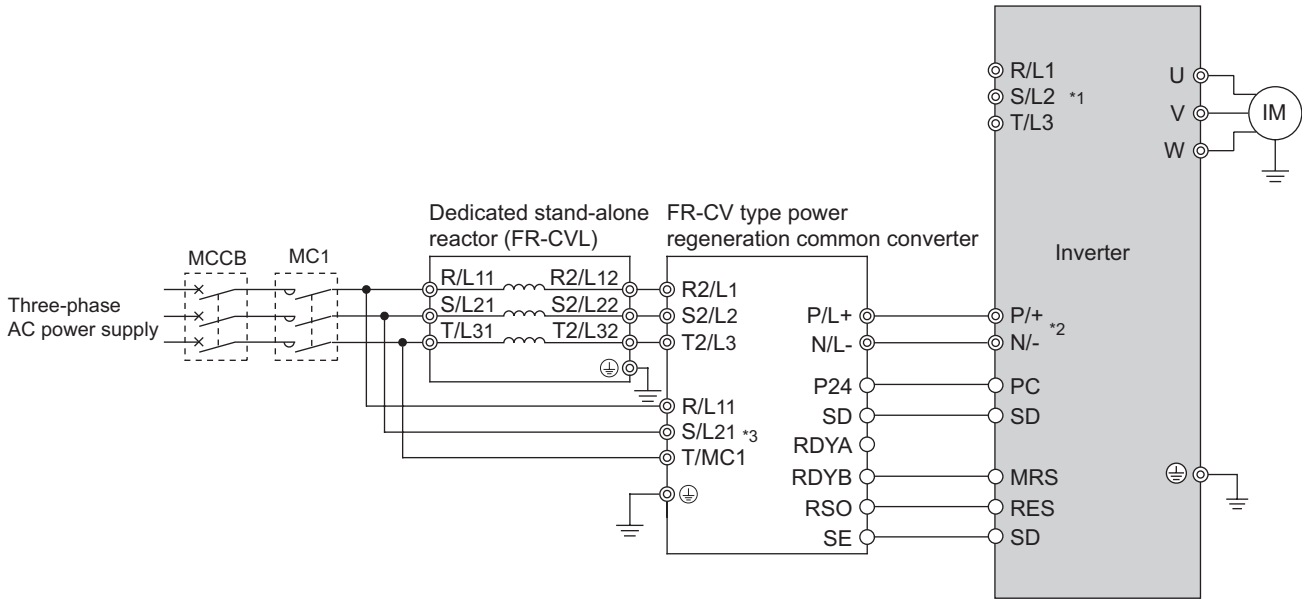

- \*1 Always keep the power input terminals R/L1, S/L2, T/L3 open. Incorrect connection will damage the inverter.
- \*2 Do not insert an MCCB between the terminals P/+–N/- (between P/L+–P/+, between N/L–N/-). Opposite polarity of terminals N/-, P/+ will damage the inverter.
- \*3 Always connect the power supply and terminals R/L11, S/L21, T/MC1. Operating the inverter without connecting them will damage the power regeneration common converter.



**NOTE**

- The voltage phases of terminals R/L11, S/L21, T/MC1 and terminals R2/L1, S2/L2, T2/L3 must be matched.
- Use sink logic (factory setting) when the FR-CV is connected. The FR-CV cannot be connected when source logic is selected.
- Do not remove a jumper across terminal P/+ and P1 except when connecting a DC reactor.

### 2.4.5 Connection of a DC reactor (FR-HEL)

When using the DC reactor (FR-HEL), connect it across terminals P/+–P1.

In this case, the jumper connected across terminals P/+–P1 must be removed. Otherwise, the reactor will not exhibit its performance.

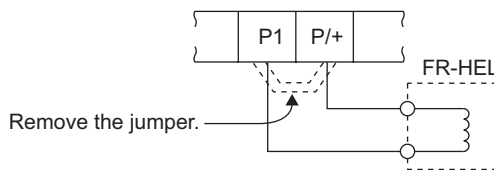

**NOTE**

- The wiring distance should be within 5m (16.4feet).
- The size of the cables used should be equal to or larger than that of the power supply cables (R/L1, S/L2, T/L3). (Refer to page 17)

# MEMO

# **3 PRECAUTIONS FOR USE OF THE INVERTER**

This chapter explains the "PRECAUTIONS FOR USE OF THE INVERTER" for use of this product.

Always read the instructions before using the equipment

3.1	EMC and leakage currents .....	36
3.2	Installation of power factor improving reactor .....	41
3.3	Power-off and magnetic contactor (MC) .....	42
3.4	Inverter-driven 400V class motor .....	43
3.5	Precautions for use of the inverter .....	44
3.6	Failsafe of the system which uses the inverter .....	46

1

2

3

4

5

6

7

### 3.1 EMC and leakage currents

#### 3.1.1 Leakage currents and countermeasures

Capacitances exist between the inverter I/O cables, other cables and earth and in the motor, through which a leakage current flows. Since its value depends on the static capacitances, carrier frequency, etc., low acoustic noise operation at the increased carrier frequency of the inverter will increase the leakage current. Therefore, take the following measures. Select the earth leakage current breaker according to its rated sensitivity current, independently of the carrier frequency setting.

##### (1) To-earth (ground) leakage currents

Leakage currents may flow not only into the inverter's own line but also into the other lines through the earth (ground) cable, etc. These leakage currents may operate earth (ground) leakage circuit breakers and earth leakage relays unnecessarily.

●Suppression technique

- If the carrier frequency setting is high, decrease the *Pr. 72 PWM frequency selection* setting. Note that motor noise increases. Selecting *Pr. 240 Soft-PWM operation selection* makes the sound inoffensive.
- By using earth leakage circuit breakers designed for harmonic and surge suppression in the inverter's own line and other line, operation can be performed with the carrier frequency kept high (with low noise).

●To-earth (ground) leakage currents

- Take caution as long wiring will increase the leakage current. Decreasing the carrier frequency of the inverter reduces the leakage current.
- Increasing the motor capacity increases the leakage current. The leakage current of the 400V class is larger than that of the 200V class.

##### (2) Line-to-line leakage currents

Harmonics of leakage currents flowing in static capacitances between the inverter output cables may operate the external thermal relay unnecessarily. When the wiring length is long (50m (164.04feet) or more) for the 400V class small-capacity model (FR-E740-170 or less), the external thermal relay is likely to operate unnecessarily because the ratio of the leakage current to the rated motor current increases.

●Line-to-line leakage current data example (200V class)

Motor Capacity (kW (HP))	Rated Motor Current (A)	Leakage Current (mA) *	
		Wiring length 50m (164.04feet)	Wiring length 100m (328.08feet)
0.4 (1/2)	1.8	310	500
0.75 (1)	3.2	340	530
1.5 (2)	5.8	370	560
2.2 (3)	8.1	400	590
3.7 (5)	12.8	440	630
5.5 (7.5)	19.4	490	680

- Dedicated motor SF-JR 4P
- Carrier frequency: 14.5kHz
- Used wire: 2mm<sup>2</sup>, 4 cores Cabtyre cable

\*The leakage currents of the 400V class are about twice as large.

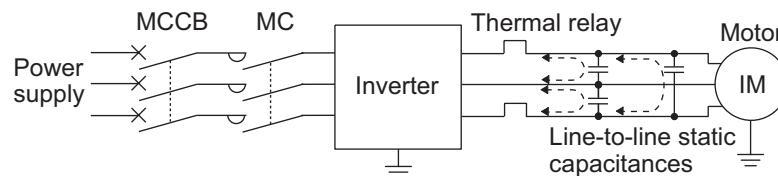

Line-to-line leakage currents path

●Measures

- Use *Pr. 9 Electronic thermal O/L relay*.
- If the carrier frequency setting is high, decrease the *Pr. 72 PWM frequency selection* setting. Note that motor noise increases. Selecting *Pr. 240 Soft-PWM operation selection* makes the sound inoffensive. To ensure that the motor is protected against line-to-line leakage currents, it is recommended to use a temperature sensor to directly detect motor temperature.

●Installation and selection of moulded case circuit breaker

Install a moulded case circuit breaker (MCCB) on the power receiving side to protect the wiring of the inverter input side. Select the MCCB according to the inverter input side power factor (which depends on the power supply voltage, output frequency and load). Especially for a completely electromagnetic MCCB, one of a slightly large capacity must be selected since its operation characteristic varies with harmonic currents. (Check it in the data of the corresponding breaker.) As an earth leakage current breaker, use the Mitsubishi earth leakage current breaker designed for harmonics and surge suppression.

**(3) Selection of rated sensitivity current of earth (ground) leakage current breaker**

When using the earth leakage current breaker with the inverter circuit, select its rated sensitivity current as follows, independently of the PWM carrier frequency.

- Breaker designed for harmonic and surge suppression  
 Rated sensitivity current:  
 $I_{\Delta n} \geq 10 \times (I_{g1} + I_{gn} + I_{gi} + I_{g2} + I_{gm})$
- Standard breaker  
 Rated sensitivity current:  
 $I_{\Delta n} \geq 10 \times \{I_{g1} + I_{gn} + I_{gi} + 3 \times (I_{g2} + I_{gm})\}$

- $I_{g1}, I_{g2}$ : Leakage currents in wire path during commercial power supply operation
- $I_{gn}$ : Leakage current of inverter input side noise filter
- $I_{gm}$ : Leakage current of motor during commercial power supply operation
- $I_{gi}$ : Leakage current of inverter unit

Example of leakage current of cable path per 1km during the commercial power supply operation when the CV cable is routed in metal conduit (200V 60Hz)

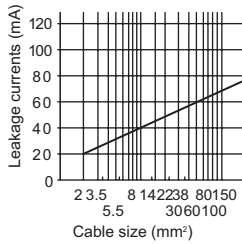

Leakage current example of three-phase induction motor during the commercial power supply operation (200V 60Hz)

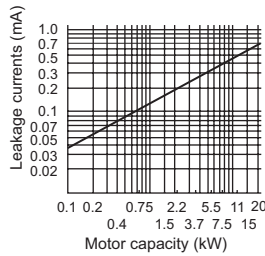

Example of leakage current per 1km during the commercial power supply operation when the CV cable is routed in metal conduit (Three-phase three-wire delta connection 400V60Hz)

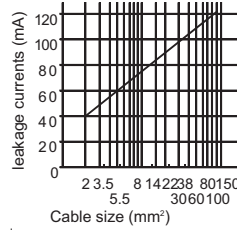

Leakage current example of three-phase induction motor during the commercial power supply operation (Totally-enclosed fan-cooled type motor 400V60Hz)

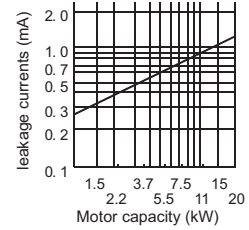

For "Δ" connection, the amount of leakage current is approx. 1/3 of the above value.

<Example>

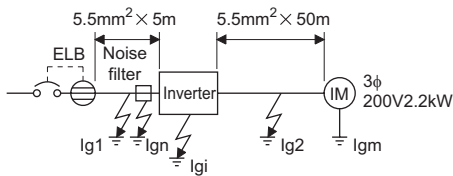

	Breaker Designed for Harmonic and Surge Suppression	Standard Breaker
Leakage current $I_{g1}$ (mA)	$33 \times \frac{5m (16.40feet)}{1000m (3280.80feet)} = 0.17$	
Leakage current $I_{gn}$ (mA)	0 (without noise filter)	
Leakage current $I_{gi}$ (mA)	1	
Leakage current $I_{g2}$ (mA)	$33 \times \frac{50m (164.04feet)}{1000m (3280.80feet)} = 1.65$	
Motor leakage current $I_{gm}$ (mA)	0.18	
Total leakage current (mA)	3.00	6.66
Rated sensitivity current (mA) ( $\geq I_g \times 10$ )	30	100



**NOTE**

- Install the earth leakage breaker (ELB) on the input side of the inverter.
- In the connection earthed-neutral system, the sensitivity current is blunt against an earth (ground) fault in the inverter output side. Earthing (Grounding) must conform to the requirements of national and local safety regulations and electrical codes. (NEC section 250, IEC 536 class 1 and other applicable standards)
- When the breaker is installed on the output side of the inverter, it may be unnecessarily operated by harmonics even if the effective value is less than the rating.  
 In this case, do not install the breaker since the eddy current and hysteresis loss will increase, leading to temperature rise.
- General products indicate the following models. .... BV-C1, BC-V, NVB, NV-L, NV-G2N, NV-G3NA, NV-2F earth leakage relay (except NV-ZHA), NV with AA neutral wire open-phase protection  
 The other models are designed for harmonic and surge suppression ....NV-C/NV-S/MN series, NV30-FA, NV50-FA, BV-C2, earth leakage alarm breaker (NF-Z), NV-ZHA, NV-H



## 3.1.2 EMC measures

Some electromagnetic noises enter the inverter to malfunction it and others are radiated by the inverter to malfunction peripheral devices. Though the inverter is designed to have high immunity performance, it handles low-level signals, so it requires the following basic techniques. Also, since the inverter chops outputs at high carrier frequency, that could generate electromagnetic noises. If these electromagnetic noises cause peripheral devices to malfunction, EMI measures should be taken to suppress noises. These techniques differ slightly depending on EMI paths.

### (1) Basic techniques

- Do not run the power cables (I/O cables) and signal cables of the inverter in parallel with each other and do not bundle them.
- Use twisted shield cables for the detector connecting and control signal cables and connect the sheathes of the shield cables to terminal SD.
- Earth (Ground) the inverter, motor, etc. at one point.

### (2) Techniques to reduce electromagnetic noises that enter and malfunction the inverter (Immunity measures)

When devices that generate many electromagnetic noises (which use magnetic contactors, magnetic brakes, many relays, for example) are installed near the inverter and the inverter may be malfunctioned by electromagnetic noises, the following measures must be taken:

- Provide surge suppressors for devices that generate many electromagnetic noises to suppress electromagnetic noises.
- Fit data line filters (page 39) to signal cables.
- Earth (Ground) the shields of the detector connection and control signal cables with cable clamp metal.

### (3) Techniques to reduce electromagnetic noises that are radiated by the inverter to malfunction peripheral devices (EMI measures)

Inverter-generated electromagnetic noises are largely classified into those radiated by the cables connected to the inverter and inverter main circuits (I/O), those electromagnetically and electrostatically induced to the signal cables of the peripheral devices close to the main circuit power supply, and those transmitted through the power supply cables.

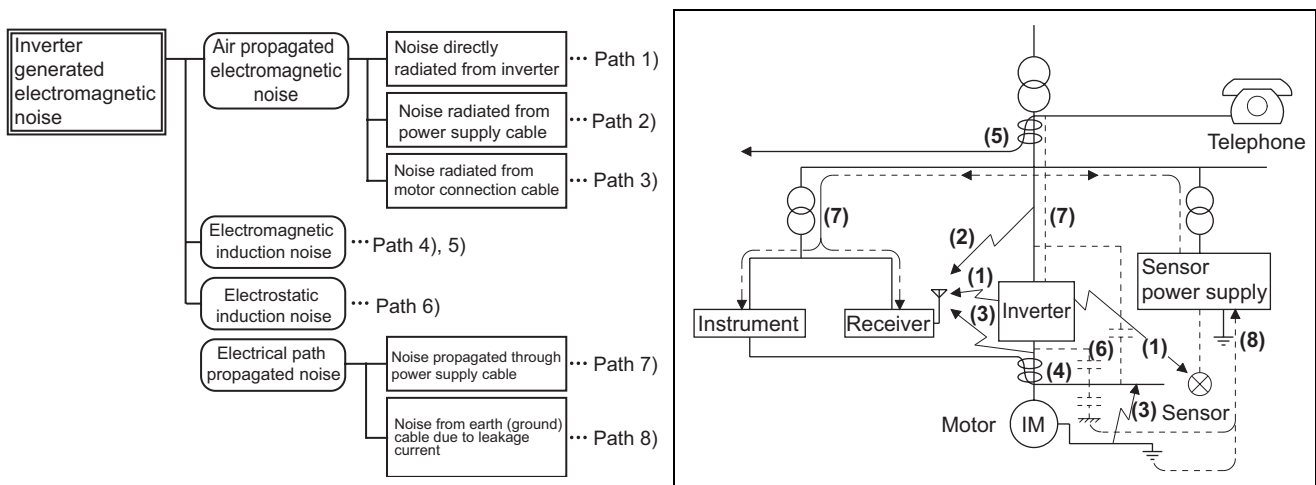

Propagation Path	Measures
(1)(2)(3)	<p>When devices that handle low-level signals and are liable to malfunction due to electromagnetic noises, e.g. instruments, receivers and sensors, are contained in the enclosure that contains the inverter or when their signal cables are run near the inverter, the devices may be malfunctioned by air-propagated electromagnetic noises. The following measures must be taken:</p> <ul style="list-style-type: none"> <li>• Install easily affected devices as far away as possible from the inverter.</li> <li>• Run easily affected signal cables as far away as possible from the inverter and its I/O cables.</li> <li>• Do not run the signal cables and power cables (inverter I/O cables) in parallel with each other and do not bundle them.</li> <li>• Insert common mode filters into I/O and capacitors between the input lines to suppress cable-radiated noises.</li> <li>• Use shield cables as signal cables and power cables and run them in individual metal conduits to produce further effects.</li> </ul>
(4)(5)(6)	<p>When the signal cables are run in parallel with or bundled with the power cables, magnetic and static induction noises may be propagated to the signal cables to malfunction the devices and the following measures must be taken:</p> <ul style="list-style-type: none"> <li>• Install easily affected devices as far away as possible from the inverter.</li> <li>• Run easily affected signal cables as far away as possible from the I/O cables of the inverter.</li> <li>• Do not run the signal cables and power cables (inverter I/O cables) in parallel with each other and do not bundle them.</li> <li>• Use shield cables as signal cables and power cables and run them in individual metal conduits to produce further effects.</li> </ul>
(7)	<p>When the power supplies of the peripheral devices are connected to the power supply of the inverter in the same line, inverter-generated noises may flow back through the power supply cables to malfunction the devices and the following measures must be taken:</p> <ul style="list-style-type: none"> <li>• Install the common mode filter (FR-BLF, FR-BSF01) to the power cables (output cable) of the inverter.</li> </ul>
(8)	<p>When a closed loop circuit is formed by connecting the peripheral device wiring to the inverter, leakage currents may flow through the earth (ground) cable of the inverter to malfunction the device. In such a case, disconnection of the earth (ground) cable of the device may cause the device to operate properly.</p>

● Data line filter

As immunity measures it may effective, provide a data line filter for the detector cable etc.

● EMC measures

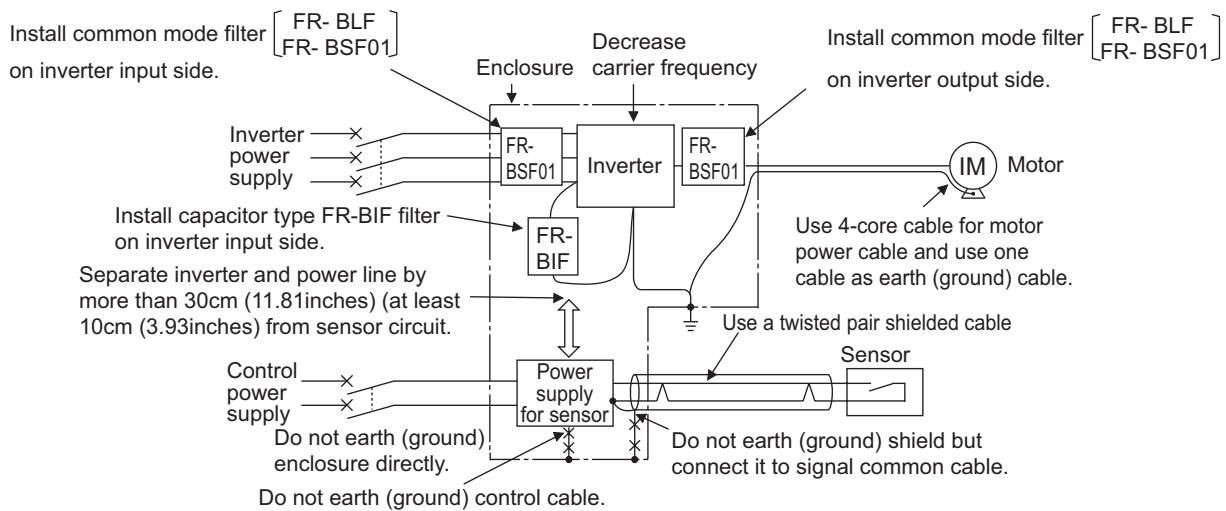

**NOTE**

- For compliance with the EU EMC directive, please refer the Installation Guideline.

## 3.1.3 Power supply harmonics

The inverter may generate power supply harmonics from its converter circuit to affect the power generator, power capacitor etc. Power supply harmonics are different from noise and leakage currents in source, frequency band and transmission path. Take the following countermeasure suppression techniques.

●The differences between harmonics and RF noises are indicated below:

Item	Harmonics	Noise
Frequency	Normally 40th to 50th degrees or less (up to 3kHz or less)	High frequency (several 10kHz to 1GHz order)
Environment	To-electric channel, power impedance	To-space, distance, wiring path
Quantitative understanding	Theoretical calculation possible	Random occurrence, quantitative grasping difficult
Generated amount	Nearly proportional to load capacity	Change with current variation ratio (larger as switching speed increases)
Affected equipment immunity	Specified in standard per equipment	Different depending on maker's equipment specifications
Suppression example	Provide reactor.	Increase distance.

### ●Suppression technique

The harmonic current generated from the inverter to the input side differs according to various conditions such as the wiring impedance, whether a reactor is used or not, and output frequency and output current on the load side.

For the output frequency and output current, we understand that they should be calculated in the conditions under the rated load at the maximum operating frequency.

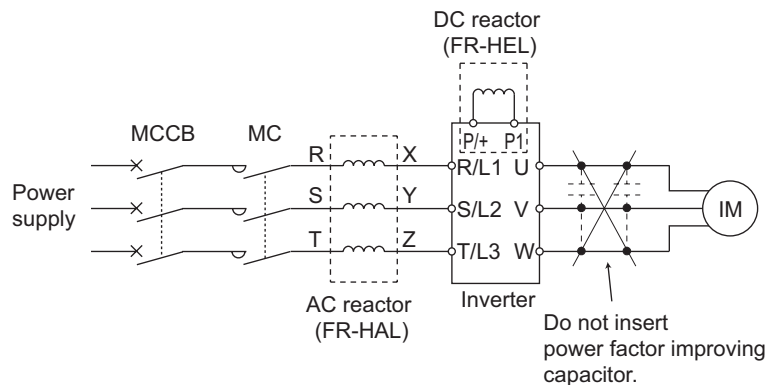

### NOTE

The power factor improving capacitor and surge suppressor on the inverter output side may be overheated or damaged by the harmonic components of the inverter output. Also, since an excessive current flows in the inverter to activate overcurrent protection, do not provide a capacitor and surge suppressor on the inverter output side when the motor is driven by the inverter. For power factor improvement, install a reactor on the inverter input side or in the DC circuit.

### 3.2 Installation of power factor improving reactor

When the inverter is connected near a large-capacity power transformer (500kVA or more) or when a power capacitor is to be switched over, an excessive peak current may flow in the power input circuit, damaging the converter circuit. To prevent this, always install an optional reactor (FR-HAL, FR-HEL).

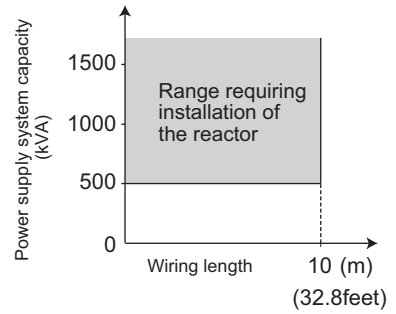
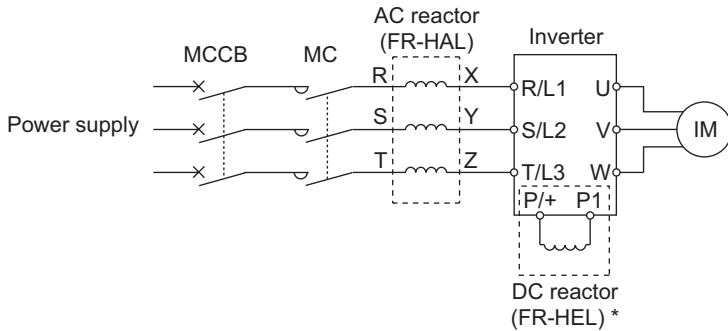

- \* When connecting the FR-HEL, remove the jumper across terminals P/+ -P1.  
The wiring length between the FR-HEL and inverter should be 5m (16.4feet) maximum and minimized.



**REMARKS**

Use the same wire size as that of the power supply wire (R/L1, S/L2, T/L3). (Refer to page 17)

### 3.3 Power-off and magnetic contactor (MC)

#### (1) Inverter input side magnetic contactor (MC)

On the inverter input side, it is recommended to provide an MC for the following purposes.

(Refer to page 4 for selection.)

- 1) To release the inverter from the power supply when the fault occurs or when the drive is not functioning (e.g. emergency stop operation). When cycle operation or heavy-duty operation is performed with an optional brake resistor connected, overheat and burnout of the discharging resistor can be prevented if a regenerative brake transistor is damaged due to insufficient heat capacity of the discharging resistor and excess regenerative brake duty.
- 2) To prevent any accident due to an automatic restart at restoration of power after an inverter stop made by a power failure
- 3) The control power supply for inverter is always running and consumes a little power. When stopping the inverter for an extended period of time, powering off the inverter will save power slightly.
- 4) To separate the inverter from the power supply to ensure safe maintenance and inspection work.

The inverter's input side MC is used for the above purpose, select class JEM1038-AC3 MC for the inverter input side current when making an emergency stop during normal operation.

**REMARKS**

Since repeated inrush currents at power on will shorten the life of the converter circuit (switching life is about 1,000,000 times.), frequent starts and stops of the MC must be avoided. Turn on/off the inverter start controlling terminals (STF, STR) to run/stop the inverter.

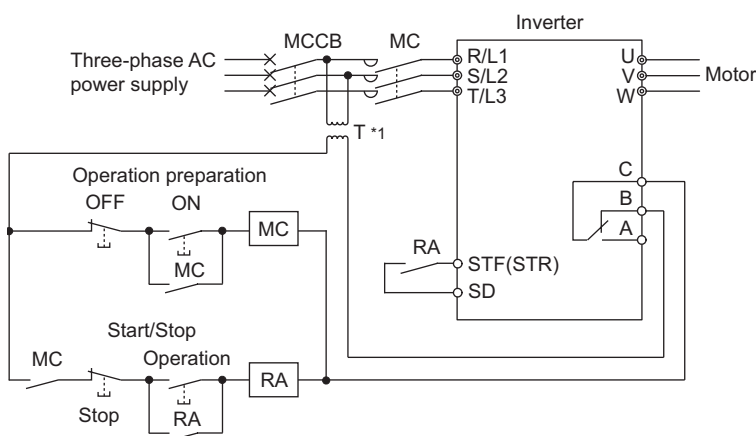

**● Inverter start/stop circuit example**

As shown on the right, always use the start signal (ON or OFF across terminals STF or STR-SD) to make a start or stop.

\*When the power supply is 400V class, install a step-down transformer.

#### (2) Handling of inverter output side magnetic contactor

Switch the magnetic contactor between the inverter and motor only when both the inverter and motor are at a stop. When the magnetic contactor is turned on while the inverter is operating, overcurrent protection of the inverter and such will activate. When an MC is provided for switching to the commercial power supply, for example, switch it on/off after the inverter and motor have stopped.



### 3.4 Inverter-driven 400V class motor

In the PWM type inverter, a surge voltage attributable to wiring constants is generated at the motor terminals. Especially for a 400V class motor, the surge voltage may deteriorate the insulation. When the 400V class motor is driven by the inverter, consider the following measures:

#### ●Measures

It is recommended to take either of the following measures:

#### (1) Rectifying the motor insulation and limiting the PWM carrier frequency according to the wiring length

For the 400V class motor, use an insulation-enhanced motor.

Specifically,

- 1) Specify the "400V class inverter-driven insulation-enhanced motor".
- 2) For the dedicated motor such as the constant-torque motor and low-vibration motor, use the "inverter-driven, dedicated motor".
- 3) Set *Pr. 72 PWM frequency selection* as indicated below according to the wiring length

	Wiring Length		
	50m (164.04feet) or less	50m to 100m (164.04feet to 328.09feet)	exceeding 100m (328.09feet)
<i>Pr. 72 PWM frequency selection</i>	15 (14.5kHz) or less	8 (8kHz) or less	2 (2kHz) or less

#### (2) Suppressing the surge voltage on the inverter side

Connect the surge voltage suppression filter (FR-ASF-H/FR-BMF-H) on the inverter output side.



#### NOTE

- For details of *Pr. 72 PWM frequency selection*, refer to page 166.
- For explanation of surge voltage suppression filter (FR-ASF-H/FR-BMF-H), refer to the manual of each option

### 3.5 Precautions for use of the inverter

---

The FR-E700 series is a highly reliable product, but incorrect peripheral circuit making or operation/handling method may shorten the product life or damage the product.

Before starting operation, always recheck the following items.

- (1) Use crimping terminals with insulation sleeve to wire the power supply and motor.
- (2) Application of power to the output terminals (U, V, W) of the inverter will damage the inverter. Never perform such wiring.
- (3) After wiring, wire offcuts must not be left in the inverter.  
Wire offcuts can cause an alarm, failure or malfunction. Always keep the inverter clean.  
When drilling mounting holes in an enclosure etc., take care not to allow chips and other foreign matter to enter the inverter.
- (4) Use cables of the size to make a voltage drop 2% maximum.  
If the wiring distance is long between the inverter and motor, a main circuit cable voltage drop will cause the motor torque to decrease especially at the output of a low frequency.  
Refer to *page 17* for the recommended wire sizes.
- (5) The overall wiring length should be 500m (1640.42feet) maximum.  
Especially for long distance wiring, the fast-response current limit function may decrease or the equipment connected to the secondary side may malfunction or become faulty under the influence of a charging current due to the stray capacity of the wiring. Therefore, note the overall wiring length. (*Refer to page 19*)
- (6) Electromagnetic wave interference  
The input/output (main circuit) of the inverter includes high frequency components, which may interfere with the communication devices (such as AM radios) used near the inverter. In this case, install the FR-BIF optional capacitor type filter (for use in the input side only) or FR-BSF01 or FR-BLF common mode filter to minimize interference.
- (7) Do not install a power factor correction capacitor, surge suppressor or capacitor type filter on the inverter output side.  
This will cause the inverter to trip or the capacitor and surge suppressor to be damaged. If any of the above devices are connected, immediately remove them.
- (8) Before starting wiring or other work after the inverter is operated, wait for at least 10 minutes after the power supply has been switched off, and check that there are no residual voltage using a tester or the like. The capacitor is charged with high voltage for some time after power off and it is dangerous.
- (9) A short circuit or earth (ground) fault on the inverter output side may damage the inverter modules.
  - Fully check the insulation resistance of the circuit prior to inverter operation since repeated short circuits caused by peripheral circuit inadequacy or an earth (ground) fault caused by wiring inadequacy or reduced motor insulation resistance may damage the inverter modules.
  - Fully check the to-earth (ground) insulation and phase to phase insulation of the inverter output side before power-on. Especially for an old motor or use in hostile atmosphere, securely check the motor insulation resistance etc.
- (10) Do not use the inverter input side magnetic contactor to start/stop the inverter.  
Always use the start signal (turn on/off terminals STF, STR-SD) to start/stop the inverter. (*Refer to page 42*)
- (11) Across P/+ and PR terminals, connect only an external regenerative brake discharging resistor.  
Do not connect a mechanical brake.  
The brake resistor can not be connected to the FR-E720-008 or 015. Leave terminals P/+ and PR open.  
Also, never short between these terminals.

(12) Do not apply a voltage higher than the permissible voltage to the inverter I/O signal circuits.

Application of a voltage higher than the permissible voltage to the inverter I/O signal circuits or opposite polarity may damage the I/O devices. Especially check the wiring to prevent the speed setting potentiometer from being connected incorrectly to short terminals 10-5.

(13) Provide electrical and mechanical interlocks for MC1 and MC2 which are used for bypass operation. When the wiring is incorrect and if there is a bypass operation circuit as shown right, the inverter will be damaged when the power supply is connected to the inverter U, V, W terminals, due to arcs generated at the time of switch-over or chattering caused by a sequence error.

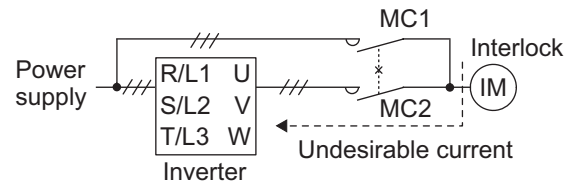

(14) If the machine must not be restarted when power is restored after a power failure, provide a magnetic contactor in the inverter's input side and also make up a sequence which will not switch on the start signal.

If the start signal (start switch) remains on after a power failure, the inverter will automatically restart as soon as the power is restored.

(15) Instructions for overload operation

When performing operation of frequent start/stop of the inverter, rise/fall in the temperature of the transistor element of the inverter will repeat due to a repeated flow of large current, shortening the life from thermal fatigue. Since thermal fatigue is related to the amount of current, the life can be increased by reducing current at locked condition, starting current, etc. Decreasing current may increase the life. However, decreasing current will result in insufficient torque and the inverter may not start. Therefore, choose the inverter which has enough allowance for current (up to 2 rank larger in capacity).

(16) Make sure that the specifications and rating match the system requirements.

(17) When the motor speed is unstable, due to change in the frequency setting signal caused by electromagnetic noises from the inverter, take the following measures when applying the motor speed by the analog signal.

- Do not run the signal cables and power cables (inverter I/O cables) in parallel with each other and do not bundle them.
- Run signal cables as far away as possible from power cables (inverter I/O cables).
- Use shield cables as signal cables.
- Install a ferrite core on the signal cable (Example: ZCAT3035-1330 TDK).



### 3.6 Failsafe of the system which uses the inverter

When a fault occurs, the inverter trips to output a fault signal. However, a fault output signal may not be output at an inverter fault occurrence when the detection circuit or output circuit fails, etc. Although Mitsubishi assures best quality products, provide an interlock which uses inverter status output signals to prevent accidents such as damage to machine when the inverter fails for some reason and at the same time consider the system configuration where failsafe from outside the inverter, without using the inverter, is enabled even if the inverter fails.

(1) Interlock method which uses the inverter status output signals

By combining the inverter status output signals to provide an interlock as shown below, an inverter alarm can be detected.

No	Interlock Method	Check Method	Used Signals	Refer to Page
1)	Inverter protective function operation	Operation check of an alarm contact Circuit error detection by negative logic	Fault output signal (ALM signal)	140
2)	Inverter running status	Operation ready signal check	Operation ready signal (RY signal)	139
3)	Inverter running status	Logic check of the start signal and running signal	Start signal (STF signal, STR signal) Running signal (RUN signal)	135, 139
4)	Inverter running status	Logic check of the start signal and output current	Start signal (STF signal, STR signal) Output current detection signal (Y12 signal)	135, 142

1) Check by the output of the inverter fault signal

When the fault occurs and trips the inverter, the fault output signal (ALM signal) is output (ALM signal is assigned to terminal ABC in the initial setting).

Check that the inverter functions properly.

In addition, negative logic can be set (on when the inverter is normal, off when the fault occurs).

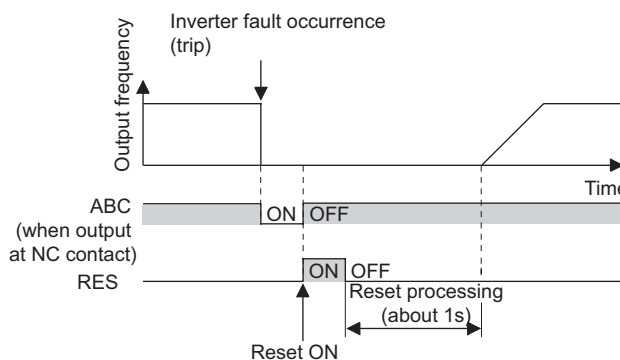

2) Checking the inverter operating status by the inverter operation ready completion signal

Operation ready signal (RY signal) is output when the inverter power is on and the inverter becomes operative.

Check if the RY signal is output after powering on the inverter.

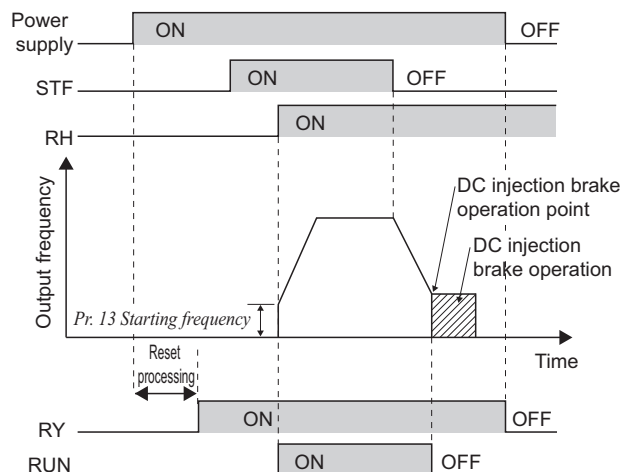

3) Checking the inverter operating status by the start signal input to the inverter and inverter running signal.

The inverter running signal (RUN signal) is output when the inverter is running (RUN signal is assigned to terminal RUN in the initial setting).

Check if RUN signal is output when inputting the start signal to the inverter (forward signal is STF signal and reverse signal is STR signal). For logic check, note that RUN signal is output for the period from the inverter decelerates until output to the motor is stopped, configure a sequence considering the inverter deceleration time

4) Checking the motor operating status by the start signal input to the inverter and inverter output current detection signal.  
 The output current detection signal (Y12 signal) is output when the inverter operates and currents flows in the motor. Check if Y12 signal is output when inputting the start signal to the inverter (forward signal is STF signal and reverse signal is STR signal). Note that the current level at which Y12 signal is output is set to 150% of the inverter rated current in the initial setting, it is necessary to adjust the level to around 20% using no load current of the motor as reference with *Pr.150 Output current detection level*.  
 For logic check, as same as the inverter running signal (RUN signal), the inverter outputs for the period from the inverter decelerates until output to the motor is stopped, configure a sequence considering the inverter deceleration time.

Output signal	Pr. 190 to Pr. 192 Setting	
	Positive logic	Negative logic
ALM	99	199
RY	11	111
RUN	0	100
Y12	12	112

- When using various signals, assign functions to *Pr.190 to Pr.192 (output terminal function selection)* referring to the table on the left.



**NOTE**

- Changing the terminal assignment using *Pr. 190 to Pr. 192 (output terminal function selection)* may affect the other functions. Make setting after confirming the function of each terminal.

(2) Backup method outside the inverter  
 Even if the interlock is provided by the inverter status signal, enough failsafe is not ensured depending on the failure status of the inverter itself. For example, even if the interlock is provided using the inverter fault output signal, start signal and RUN signal output, there is a case where a fault output signal is not output and RUN signal is kept output even if an inverter fault occurs.  
 Provide a speed detector to detect the motor speed and current detector to detect the motor current and consider the backup system such as checking up as below according to the level of importance of the system.

1) Start signal and actual operation check  
 Check the motor running and motor current while the start signal is input to the inverter by comparing the start signal to the inverter and detected speed of the speed detector or detected current of the current detector. Note that the motor current runs as the motor is running for the period until the motor stops since the inverter starts decelerating even if the start signal turns off. For the logic check, configure a sequence considering the inverter deceleration time. In addition, it is recommended to check the three-phase current when using the current detector.

2) Command speed and actual operation check  
 Check if there is no gap between the actual speed and commanded speed by comparing the inverter speed command and detected speed of the speed detector.

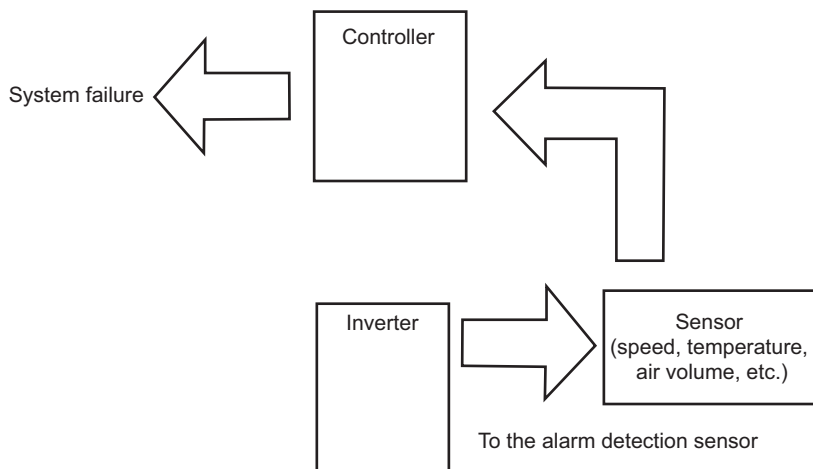

# MEMO

# 4 PARAMETERS

---

This chapter explains the "PARAMETERS" for use of this product.

Always read the instructions before using the equipment

---

The abbreviations in the explanations below are as follows:

**V/F** .....V/F control,

**AD MFVC** .....Advanced magnetic flux vector control,

**GP MFVC** .....General-purpose magnetic-flux vector control  
(Parameters without any indication are valid for all control)

1

2

3

4

5

6

7

## 4.1 Operation panel

### 4.1.1 Names and functions of the operation panel

The operation panel cannot be removed from the inverter.

**Operation mode indication**  
 PU: Lit to indicate PU operation mode.  
 EXT: Lit to indicate external operation mode.  
 NET: Lit to indicate network operation mode.

**Unit indication**  
 Hz: Lit to indicate frequency.  
 ALit to indicate current.  
 (Off to indicate voltage and flicker to indicate set frequency monitor.)

**Monitor (4-digit LED)**  
 Shows the frequency, parameter number, etc.

**Setting dial**  
 (Setting dial: Mitsubishi inverter dial)  
 Used to change the frequency setting and parameter values.  
 Press to display the following.  
 • Displays the set frequency in the monitor mode  
 • Currently set value is displayed during calibration  
 • Displays the order in the faults history mode

**Mode switchover**  
 Used to change each setting mode.  
 Pressing **PU/EXT** simultaneously changes the operation mode. (Refer to page 52)  
 Pressing for a while (2s) can lock operation. (Refer to page 260)

**Determination of each setting**  
 If pressed during operation, monitor changes as below;

```

    graph TD
      A[Running frequency] --> B[Output current]
      B --> C[Output voltage]
      C --> A
    
```

**Operating status display**  
 Lit or flicker during inverter operation. \*  
 \* On: Indicates that forward rotation operation is being performed.  
 Slow flickering (1.4s cycle): Reverse rotation operation  
 Fast flickering (0.2s cycle):  
 When **RUN** was pressed or the start command was given, but the operation can not be made.  
 • When the start command is given and the frequency command is less than the starting frequency.  
 • When the MRS signal is input.

**Parameter setting mode**  
 Lit to indicate parameter setting mode.

**Monitor indication**  
 Lit to indicate monitoring mode.

**Stop operation**  
 Fault can be reset

**Operation mode switchover**  
 Used to switch between the PU and external operation mode.  
 When using the external operation mode (operation using a separately connected frequency setting potentiometer and start signal), press this key to light up the EXT indication.  
 (Press **MODE** simultaneously (0.5s) (Refer to page 52), or change Pr: 79 setting to change to combined mode .)  
 PU: PU operation mode  
 EXT: External operation mode  
 Cancels PU stop also.

**Start command**  
 The rotation direction can be selected by setting Pr: 40.

### 4.1.2 Basic operation (factory setting)

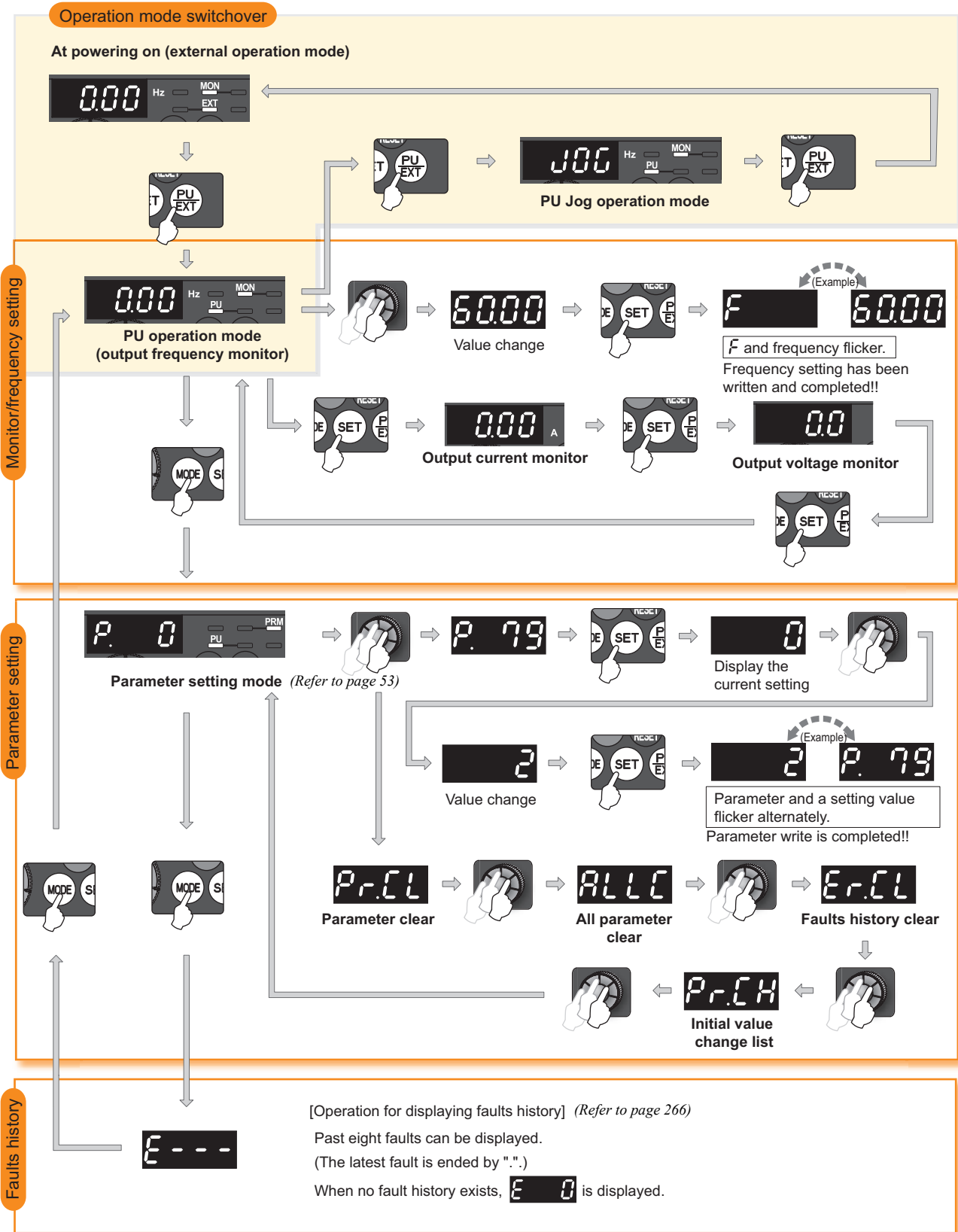



## 4.1.3 Easy operation mode setting (easy setting mode)

Setting of Pr. 79 Operation mode selection according to combination of the start command and speed command can be easily made.



Operation example









Start command: external (STF/STR), frequency command: operate with 

**Operation**



1. Screen at powering on  
The monitor display appears.
2. Press  and  for 0.5s.
3. Turn  until 79-3 appears.  
(refer to the table below for other settings)

**Display**





Operation Panel Indication	Operation Method	
	Start command	Frequency command
		
	External (STF, STR)	Analog voltage input
	External (STF, STR)	
		Analog voltage input







4. Press  to set.

 →  

**Flicker ... Parameter setting complete!!**  
↓  
**The monitor display appears after 3s.**









### REMARKS

- ? Er 1 is displayed ... Why?
  -  Pr. 79 is not registered in user group with "1" in Pr. 160 User group read selection.
  -  Parameter write is disabled with "1" set in Pr. 77.
- ? Er 2 is displayed ... Why?
  -  Setting can not be made during operation. Turn the start switch (, STF or STR) off.
- Press  before pressing  to return to the monitor display without setting. In this case, the mode changes to external operation mode when performed in the PU operation mode (PU JOG operation mode) and PU operation mode when performed in the external operation mode.
- Reset can be made with .

### 4.1.4 Change the parameter setting value

**Changing example** Change the *Pr. 1 Maximum frequency* setting.

#### Operation

1. Screen at powering on  
The monitor display appears.
2. Press  to choose the PU operation mode.
3. Press  to choose the parameter setting mode.
4. Turn  until *P. 1* (*Pr. 1*) appears.
5. Press  to read the currently set value.  
"1200"(120.0Hz (initial value) appears.
6. Turn  to change the set value to "6000" (60.00Hz).
7. Press  to set.

#### Display

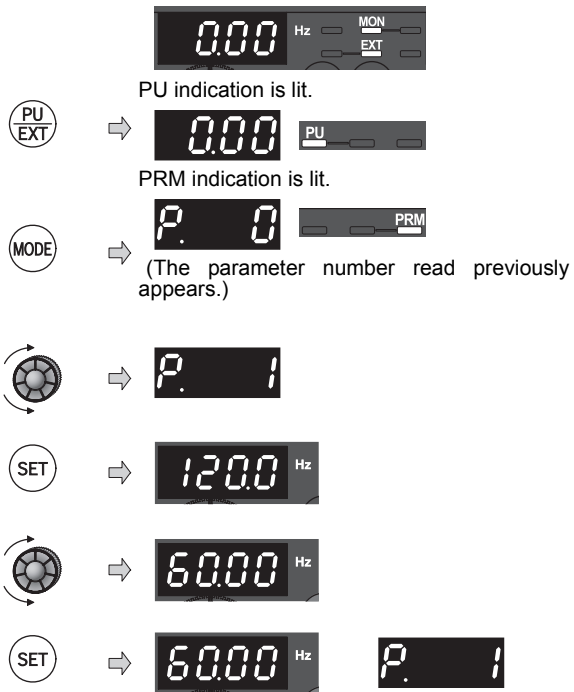





PU indication is lit.

PRM indication is lit.

(The parameter number read previously appears.)

**Flicker...Parameter setting complete!!**

- Turn  to read another parameter.
- Press  to show the setting again.
- Press  twice to show the next parameter.
- Press  twice to return the monitor to frequency monitor.

#### REMARKS

? *Er 1* to *Er 4* is displayed...Why?

-  *Er 1* appears..... Write disable error
- Er 2* appears..... Write error during operation
- Er 3* appears..... Calibration error
- Er 4* appears..... Mode designation error

(For details, refer to page 272.)

- The number of digits displayed on the operation panel is four. Only the upper four digits of values can be displayed and set. If the values to be displayed have five digits or more including decimal places, the fifth or later numerals can not be displayed nor set. (Example) For *Pr. 1*  
When 60Hz is set, 60.00 is displayed.  
When 120Hz is set, 120.0 is displayed and second decimal place is not displayed nor set.

### 4.1.5 Setting dial push

Push the setting dial () to display the set frequency\* currently set.

\* Appears when PU operation mode or external/PU combined operation mode 1 is selected (*Pr. 79* ="3").









## 4.2 Parameter list

For simple variable-speed operation of the inverter, the initial setting of the parameters may be used as they are. Set the necessary parameters to meet the load and operational specifications. Parameter setting, change and check can be made from the operation panel. For details of parameters, refer to the instruction manual.

### REMARKS

-  indicates simple mode parameters. (initially set to extended mode)
- The parameters surrounded by a black border in the table allow its setting to be changed during operation even if "0" (initial value) is set in Pr. 77 Parameter write selection.

Function	Parameter	Name	Setting Range	Minimum Setting Increments	Initial Value	Refer to Page	Customer Setting
Basic functions	0	Torque boost	0 to 30%	0.1%	6/4/3/2% *1	77	
	1	Maximum frequency	0 to 120Hz	0.01Hz	120Hz	89	
	2	Minimum frequency	0 to 120Hz	0.01Hz	0Hz	89	
	3	Base frequency	0 to 400Hz	0.01Hz	60Hz	91	
	4	Multi-speed setting (high speed)	0 to 400Hz	0.01Hz	60Hz	95	
	5	Multi-speed setting (middle speed)	0 to 400Hz	0.01Hz	30Hz	95	
	6	Multi-speed setting (low speed)	0 to 400Hz	0.01Hz	10Hz	95	
	7	Acceleration time	0 to 3600/360s	0.1/0.01s	5/10/15s *2	102	
	8	Deceleration time	0 to 3600/360s	0.1/0.01s	5/10/15s *2	102	
	9	Electronic thermal O/L relay	0 to 500A	0.01A	Rated inverter current	109	
DC injection brake	10	DC injection brake operation frequency	0 to 120Hz	0.01Hz	3Hz	121	
	11	DC injection brake operation time	0 to 10s	0.1s	0.5s	121	
	12	DC injection brake operation voltage	0 to 30%	0.1%	6/4/2% *3	121	
—	13	Starting frequency	0 to 60Hz	0.01Hz	0.5Hz	105	
—	14	Load pattern selection	0 to 3	1	0	93	
JOG operation	15	Jog frequency	0 to 400Hz	0.01Hz	5Hz	97	
	16	Jog acceleration/deceleration time	0 to 3600/360s	0.1/0.01s	0.5s	97	
—	17	MRS input selection	0, 2, 4	1	0	133	
—	18	High speed maximum frequency	120 to 400Hz	0.01Hz	120Hz	89	
—	19	Base frequency voltage	0 to 1000V, 8888, 9999	0.1V	9999	91	
Acceleration/ deceleration time	20	Acceleration/deceleration reference frequency	1 to 400Hz	0.01Hz	60Hz	102	
	21	Acceleration/deceleration time increments	0, 1	1	0	102	
Stall prevention	22	Stall prevention operation level	0 to 200%	0.1%	150%	85	
	23	Stall prevention operation level compensation factor at double speed	0 to 200%, 9999	0.1%	9999	85	
Multi-speed setting	24	Multi-speed setting (speed 4)	0 to 400Hz, 9999	0.01Hz	9999	95	
	25	Multi-speed setting (speed 5)	0 to 400Hz, 9999	0.01Hz	9999	95	
	26	Multi-speed setting (speed 6)	0 to 400Hz, 9999	0.01Hz	9999	95	
	27	Multi-speed setting (speed 7)	0 to 400Hz, 9999	0.01Hz	9999	95	
—	29	Acceleration/deceleration pattern selection	0, 1, 2	1	0	106	
—	30	Regenerative function selection	0, 1, 2	1	0	122, 154	

- Symbols in the table indicate parameters which function when an option is mounted.  
 ..... FR-A7AX E kit,  ..... FR-A7AY E kit,  ..... FR-A7AR E kit,  ..... FR-A7NC E kit,  ..... FR-A7ND E kit,  ..... FR-A7NL E kit,  ..... FR-A7NP E kit
- These instruction codes are used for parameter read and write by using Mitsubishi inverter protocol with the RS-485 communication. (Refer to page 203 for RS-485 communication)
- "O" indicates valid and "x" indicates invalid of "control mode-based correspondence table", "parameter copy", "parameter clear", and "all parameter clear".

Parameter	Remarks	Instruction Code			Control Mode-based Correspondence Table			Parameter		
		Read	Write	Extended	V/F	GP MFVC	AD MFVC	Copy	Clear	All clear
0		00	80	0	O	x	x	O	O	O
1		01	81	0	O	O	O	O	O	O
2		02	82	0	O	O	O	O	O	O
3		03	83	0	O	x	x	O	O	O
4		04	84	0	O	O	O	O	O	O
5		05	85	0	O	O	O	O	O	O
6		06	86	0	O	O	O	O	O	O
7		07	87	0	O	O	O	O	O	O
8		08	88	0	O	O	O	O	O	O
9		09	89	0	O	O	O	O	O	O
10		0A	8A	0	O	O	O	O	O	O
11		0B	8B	0	O	O	O	O	O	O
12		0C	8C	0	O	O	O	O	O	O
13		0D	8D	0	O	O	O	O	O	O
14		0E	8E	0	O	x	x	O	O	O
15		0F	8F	0	O	O	O	O	O	O
16		10	90	0	O	O	O	O	O	O
17		11	91	0	O	O	O	O	O	O
18		12	92	0	O	O	O	O	O	O
19		13	93	0	O	x	x	O	O	O
20		14	94	0	O	O	O	O	O	O
21		15	95	0	O	O	O	O	O	O
22		16	96	0	O	O	O	O	O	O
23		17	97	0	O	O	O	O	O	O
24		18	98	0	O	O	O	O	O	O
25		19	99	0	O	O	O	O	O	O
26		1A	9A	0	O	O	O	O	O	O
27		1B	9B	0	O	O	O	O	O	O
29		1D	9D	0	O	O	O	O	O	O
30		1E	9E	0	O	O	O	O	O	O

Function	Parameter	Name	Setting Range	Minimum Setting Increments	Initial Value	Refer to Page	Customer Setting
32	Frequency jump 1B	0 to 400Hz, 9999	0.01Hz	9999	90		
33	Frequency jump 2A	0 to 400Hz, 9999	0.01Hz	9999	90		
34	Frequency jump 2B	0 to 400Hz, 9999	0.01Hz	9999	90		
35	Frequency jump 3A	0 to 400Hz, 9999	0.01Hz	9999	90		
36	Frequency jump 3B	0 to 400Hz, 9999	0.01Hz	9999	90		
—	37	Speed display	0, 0.01 to 9998	0.001	0	145	
—	40	RUN key rotation direction selection	0, 1	1	0	259	
Frequency detection	41	Up-to-frequency sensitivity	0 to 100%	0.1%	10%	141	
	42	Output frequency detection	0 to 400Hz	0.01Hz	6Hz	141	
	43	Output frequency detection for reverse rotation	0 to 400Hz, 9999	0.01Hz	9999	141	
Second functions	44	Second acceleration/deceleration time	0 to 3600/360s	0.1/0.01s	5/10/15s *2	102, 241	
	45	Second deceleration time	0 to 3600/360s, 9999	0.1/0.01s	9999	102, 241	
	46	Second torque boost	0 to 30%, 9999	0.1%	9999	77	
	47	Second V/F (base frequency)	0 to 400Hz, 9999	0.01Hz	9999	91	
	48	Second stall prevention operation current	0 to 200%, 9999	0.1%	9999	85	
—	51	Second electronic thermal O/L relay	0 to 500A, 9999	0.01A	9999	109	
Monitor functions	52	DU/PU main display data selection	0, 5, 7 to 12, 14, 20, 23 to 25, 52 to 57, 61, 62, 100	1	0	146	
	55	Frequency monitoring reference	0 to 400Hz	0.01Hz	60Hz	151	
	56	Current monitoring reference	0 to 500A	0.01A	Rated inverter current	151	
Automatic restart functions	57	Restart coasting time	0, 0.1 to 5s, 9999	0.1s	9999	154	
	58	Restart cushion time	0 to 60s	0.1s	1s	154	
—	59	Remote function selection	0, 1, 2, 3	1	0	99	
—	60	Energy saving control selection	0, 9	1	0	165	
Automatic acceleration /deceleration	61	Reference current	0 to 500A, 9999	0.01A	9999	107	
	62	Reference value at acceleration	0 to 200%, 9999	1%	9999	107	
	63	Reference value at deceleration	0 to 200%, 9999	1%	9999	107	
—	65	Retry selection	0 to 5	1	0	162	
—	66	Stall prevention operation reduction starting frequency	0 to 400Hz	0.01Hz	60Hz	85	
Retry	67	Number of retries at fault occurrence	0 to 10, 101 to 110	1	0	162	
	68	Retry waiting time	0.1 to 360s	0.1s	1s	162	
	69	Retry count display erase	0	1	0	162	
—	70	Special regenerative brake duty	0 to 30%	0.1%	0%	122	
—	71	Applied motor	0, 1, 3 to 6, 13 to 16, 23, 24, 40, 43, 44, 50, 53, 54	1	0	79, 82, 111, 113,	
—	72	PWM frequency selection	0 to 15	1	1	166	
—	73	Analog input selection	0, 1, 10, 11	1	1	168	
—	74	Input filter time constant	0 to 8	1	1	170	

Parameter	Remarks	Instruction Code			Control Mode-based Correspondence Table			Parameter		
		Read	Write	Extended	V/F	GP MFVC	AD MFVC	Copy	Clear	All clear
31		1F	9F	0	○	○	○	○	○	○
32		20	A0	0	○	○	○	○	○	○
33		21	A1	0	○	○	○	○	○	○
34		22	A2	0	○	○	○	○	○	○
35		23	A3	0	○	○	○	○	○	○
36		24	A4	0	○	○	○	○	○	○
37		25	A5	0	○	○	○	○	○	○
40		28	A8	0	○	○	○	○	○	○
41		29	A9	0	○	○	○	○	○	○
42		2A	AA	0	○	○	○	○	○	○
43		2B	AB	0	○	○	○	○	○	○
44		2C	AC	0	○	○	○	○	○	○
45		2D	AD	0	○	○	○	○	○	○
46		2E	AE	0	○	×	×	○	○	○
47		2F	AF	0	○	×	×	○	○	○
48		30	B0	0	○	○	○	○	○	○
51		33	B3	0	○	○	○	○	○	○
52		34	B4	0	○	○	○	○	○	○
55		37	B7	0	○	○	○	○	○	○
56		38	B8	0	○	○	○	○	○	○
57		39	B9	0	○	○	○	○	○	○
58		3A	BA	0	○	○	○	○	○	○
59		3B	BB	0	○	○	○	○	○	○
60		3C	BC	0	○	×	×	○	○	○
61		3D	BD	0	○	○	○	○	○	○
62		3E	BE	0	○	○	○	○	○	○
63		3F	BF	0	○	○	○	○	○	○
65		41	C1	0	○	○	○	○	○	○
66		42	C2	0	○	○	○	○	○	○
67		43	C3	0	○	○	○	○	○	○
68		44	C4	0	○	○	○	○	○	○
69		45	C5	0	○	○	○	○	○	○
70		46	C6	0	○	○	○	○	○	○
71		47	C7	0	○	○	○	○	○	○
72		48	C8	0	○	○	○	○	○	○
73		49	C9	0	○	○	○	○	×	○
74		4A	CA	0	○	○	○	○	○	○

Function	Parameter	Name	Setting Range	Minimum Setting Increments	Initial Value	Refer to Page	Customer Setting
—	75	Reset selection/disconnected PU detection/PU stop selection	0 to 3, 14 to 17	1	14	176	
—	77	Parameter write selection	0, 1, 2	1	0	179	
—	78	Reverse rotation prevention selection	0, 1, 2	1	0	180	
—	⊙ 79	Operation mode selection	0, 1, 2, 3, 4, 6, 7	1	0	183, 193	
Motor constants	80	Motor capacity	0.1 to 15kW, 9999	0.01kW	9999	76, 79, 82, 113	
	81	Number of motor poles	2, 4, 6, 8, 10, 9999	1	9999	76, 79, 82, 113	
	82	Motor excitation current	0 to 500A (0 to ****), 9999 *5	0.01A (1) *5	9999	113	
	83	Motor rated voltage	0 to 1000V	0.1V	200V/400V *7	113	
	84	Rated motor frequency	10 to 120Hz	0.01Hz	60Hz	113	
	89	Speed control gain (advanced magnetic flux vector)	0 to 200%, 9999	0.1%	9999	79	
	90	Motor constant (R1)	0 to 50Ω (0 to ****), 9999 *5	0.001Ω (1) *5	9999	113	
	91	Motor constant (R2)	0 to 50Ω (0 to ****), 9999 *5	0.001Ω (1) *5	9999	113	
	92	Motor constant (L1)	0 to 1000mH (0 to 50Ω, 0 to ****), 9999 *5	0.1mH (0.001Ω, 1) *5	9999	113	
	93	Motor constant (L2)	0 to 1000mH (0 to 50Ω, 0 to ****), 9999 *5	0.1mH (0.001Ω, 1) *5	9999	113	
94	Motor constant (X)	0 to 100% (0 to 500Ω, 0 to ****), 9999 *5	0.1% (0.01Ω, 1) *5	9999	113		
96	Auto tuning setting/status	0, 1, 11, 21	1	0	113, 154		
PU connector communication	117	PU communication station number	0 to 31 (0 to 247)	1	0	203, 220	
	118	PU communication speed	48, 96, 192, 384	1	192	203, 220	
	119	PU communication stop bit length	0, 1, 10, 11	1	1	203	
	120	PU communication parity check	0, 1, 2	1	2	203, 220	
	121	Number of PU communication retries	0 to 10, 9999	1	1	204	
	122	PU communication check time interval	0, 0.1 to 999.8s, 9999	0.1s	0	204, 220	
	123	PU communication waiting time setting	0 to 150ms, 9999	1	9999	203	
	124	PU communication CR/LF selection	0, 1, 2	1	1	203	
—	⊙ 125	Terminal 2 frequency setting gain frequency	0 to 400Hz	0.01Hz	60Hz	171	
—	⊙ 126	Terminal 4 frequency setting gain frequency	0 to 400Hz	0.01Hz	60Hz	171	

Parameter	Remarks	Instruction Code			Control Mode-based Correspondence Table			Parameter		
		Read	Write	Extended	V/F	GP MFVC	AD MFVC	Copy	Clear	All clear
75		4B	CB	0	○	○	○	○	×	×
77		4D	CD *4	0	○	○	○	○	○	○
78		4E	GE	0	○	○	○	○	○	○
⊙ 79		4F	CF *4	0	○	○	○	○	○	○
80		50	D0	0	×	○	○	○	○	○
81		51	D1	0	×	○	○	○	○	○
82		52	D2	0	×	○	○	○	×	○
83		53	D3	0	×	○	○	○	○	○
84		54	D4	0	×	○	○	○	○	○
89		59	D9	0	×	○	×	○	×	○
90		5A	DA	0	○	○	○	○	×	○
91		5B	DB	0	×	○	○	○	×	○
92		5C	DC	0	×	○	○	○	×	○
93		5D	DD	0	×	○	○	○	×	○
94		5E	DE	0	×	○	○	○	×	○
96		60	E0	0	○	○	○	○	×	○
117		11	91	1	○	○	○	○	○	○
118		12	92	1	○	○	○	○	○	○
119		13	93	1	○	○	○	○	○	○
120		14	94	1	○	○	○	○	○	○
121		15	95	1	○	○	○	○	○	○
122		16	96	1	○	○	○	○	○	○
123		17	97	1	○	○	○	○	○	○
124		18	98	1	○	○	○	○	○	○
⊙ 125		19	99	1	○	○	○	○	×	○
⊙ 126		1A	9A	1	○	○	○	○	×	○

Function	Parameter	Name	Setting Range	Minimum Setting Increments	Initial Value	Refer to Page	Customer Setting	
PID operation	127	PID control automatic switchover frequency	0 to 400Hz, 9999	0.01Hz	9999	234		
	128	PID action selection	0, 20, 21, 40 to 43, 50, 51, 60, 61	1	0	234, 241		
	129	PID proportional band	0.1 to 1000%, 9999	0.1%	100%	234, 241		
	130	PID integral time	0.1 to 3600s, 9999	0.1s	1s	234, 241		
	131	PID upper limit	0 to 100%, 9999	0.1%	9999	234, 241		
	132	PID lower limit	0 to 100%, 9999	0.1%	9999	234, 241		
	133	PID action set point	0 to 100%, 9999	0.01%	9999	234, 241		
	134	PID differential time	0.01 to 10.00s, 9999	0.01s	9999	234, 241		
PU	145	PU display language selection	0 to 7	1	1	259		
—	146	Parameter for manufacturer setting. Do not set.						
—	147	Acceleration/deceleration time switching frequency	0 to 400Hz, 9999	0.01Hz	9999	102		
Current detection	150	Output current detection level	0 to 200%	0.1%	150%	142		
	151	Output current detection signal delay time	0 to 10s	0.1s	0s	142		
	152	Zero current detection level	0 to 200%	0.1%	5%	142		
	153	Zero current detection time	0 to 1s	0.01s	0.5s	142		
—	156	Stall prevention operation selection	0 to 31, 100, 101	1	0	85		
—	157	OL signal output timer	0 to 25s, 9999	0.1s	0s	85		
—	158	AM terminal function selection	1 to 3, 5, 7 to 12, 14, 21, 24, 52, 53, 61, 62	1	1	146		
—	Ⓢ 160	User group read selection	0, 1, 9999	1	0	180		
—	161	Frequency setting/key lock operation selection	0, 1, 10, 11	1	0	260		
Automatic restart functions	162	Automatic restart after instantaneous power failure selection	0, 1, 10, 11	1	1	154		
	165	Stall prevention operation level for restart	0 to 200%	0.1%	150%	154		
—	168	Parameter for manufacturer setting. Do not set.						
—	169	Parameter for manufacturer setting. Do not set.						
Cumulative monitor clear	170	Watt-hour meter clear	0, 10, 9999	1	9999	146		
	171	Operation hour meter clear	0, 9999	1	9999	146		
User group	172	User group registered display/batch clear	9999, (0 to 16)	1	0	180		
	173	User group registration	0 to 999, 9999	1	9999	180		
	174	User group clear	0 to 999, 9999	1	9999	180		

Parameter	Remarks	Instruction Code			Control Mode-based Correspondence Table			Parameter		
		Read	Write	Extended	V/F	GP MFVC	AD MFVC	Copy	Clear	All clear
127		1B	9B	1	○	○	○	○	○	○
128		1C	9C	1	○	○	○	○	○	○
129		1D	9D	1	○	○	○	○	○	○
130		1E	9E	1	○	○	○	○	○	○
131		1F	9F	1	○	○	○	○	○	○
132		20	A0	1	○	○	○	○	○	○
133		21	A1	1	○	○	○	○	○	○
134		22	A2	1	○	○	○	○	○	○
145		2D	AD	1	○	○	○	○	×	×
146	Parameter for manufacturer setting. Do not set.									
147		2F	AF	1	○	○	○	○	○	○
150		32	B2	1	○	○	○	○	○	○
151		33	B3	1	○	○	○	○	○	○
152		34	B4	1	○	○	○	○	○	○
153		35	B5	1	○	○	○	○	○	○
156		38	B8	1	○	○	○	○	○	○
157		39	B9	1	○	○	○	○	○	○
158		3A	BA	1	○	○	○	○	○	○
Ⓢ 160		00	80	2	○	○	○	○	○	○
161		01	81	2	○	○	○	○	×	○
162		02	82	2	○	○	○	○	○	○
165		05	85	2	○	○	○	○	○	○
168	Parameter for manufacturer setting. Do not set.									
169	Parameter for manufacturer setting. Do not set.									
170		0A	8A	2	○	○	○	○	×	○
171		0B	8B	2	○	○	○	×	×	×
172		0C	8C	2	○	○	○	○	×	×
173		0D	8D	2	○	○	○	×	×	×
174		0E	8E	2	○	○	○	×	×	×

Function	Parameter	Name	Setting Range	Minimum Setting Increments	Initial Value	Refer to Page	Customer Setting
Input terminal function assignment	178	STF terminal function selection	0 to 5, 7, 8, 10, 12, 14 to 16, 18, 24, 25, 60, 62, 65 to 67, 9999	1	60	131	
	179	STR terminal function selection	0 to 5, 7, 8, 10, 12, 14 to 16, 18, 24, 25, 61, 62, 65 to 67, 9999	1	61	131	
	180	RL terminal function selection	0 to 5, 7, 8, 10, 12, 14 to 16, 18, 24, 25, 62, 65 to 67, 9999	1	0	131	
	181	RM terminal function selection		1	1	131	
	182	RH terminal function selection		1	2	131	
	183	MRS terminal function selection		1	24	131	
	184	RES terminal function selection		1	62	131	
Output terminal function assignment	190	RUN terminal function selection	0, 1, 3, 4, 7, 8, 11 to 16, 20, 25, 26, 46, 47, 64, 90, 91, 93, 95, 96, 98, 99, 100, 101, 103, 104, 107, 108, 111 to 116, 120, 125, 126, 146, 147, 164, 190, 191, 193, 195, 196, 198, 199, 9999	1	0	137	
	191	FU terminal function selection	0, 1, 3, 4, 7, 8, 11 to 16, 20, 25, 26, 46, 47, 64, 90, 91, 95, 96, 98, 99, 100, 101, 103, 104, 107, 108, 111 to 116, 120, 125, 126, 146, 147, 164, 190, 191, 193, 195, 196, 198, 199, 9999	1	4	137	
	192	A,B,C terminal function selection	0, 1, 3, 4, 7, 8, 11 to 16, 20, 25, 26, 46, 47, 64, 90, 91, 95, 96, 98, 99, 100, 101, 103, 104, 107, 108, 111 to 116, 120, 125, 126, 146, 147, 164, 190, 191, 195, 196, 198, 199, 9999	1	99	137	
Multi-speed setting	232	Multi-speed setting (speed 8)	0 to 400Hz, 9999	0.01Hz	9999	95	
	233	Multi-speed setting (speed 9)	0 to 400Hz, 9999	0.01Hz	9999	95	
	234	Multi-speed setting (speed 10)	0 to 400Hz, 9999	0.01Hz	9999	95	
	235	Multi-speed setting (speed 11)	0 to 400Hz, 9999	0.01Hz	9999	95	
	236	Multi-speed setting (speed 12)	0 to 400Hz, 9999	0.01Hz	9999	95	
	237	Multi-speed setting (speed 13)	0 to 400Hz, 9999	0.01Hz	9999	95	
	238	Multi-speed setting (speed 14)	0 to 400Hz, 9999	0.01Hz	9999	95	
	239	Multi-speed setting (speed 15)	0 to 400Hz, 9999	0.01Hz	9999	95	
—	240	Soft-PWM operation selection	0, 1	1	1	166	
—	241	Analog input display unit switchover	0, 1	1	0	171	
—	244	Cooling fan operation selection	0, 1	1	1	250	
Slip compensation	245	Rated slip	0 to 50%, 9999	0.01%	9999	84	
	246	Slip compensation time constant	0.01 to 10s	0.01s	0.5s	84	
	247	Constant-power range slip compensation selection	0, 9999	1	9999	84	
—	249	Earth (ground) fault detection at start	0, 1	1	0	164	
—	250	Stop selection	0 to 100s, 1000 to 1100s, 8888, 9999	0.1s	9999	124, 135	
Life diagnosis	251	Output phase loss protection selection	0, 1	1	1	164	
	255	Life alarm status display	(0 to 15)	1	0	251	
	256	Inrush current limit circuit life display	(0 to 100%)	1%	100%	251	
	257	Control circuit capacitor life display	(0 to 100%)	1%	100%	251	
	258	Main circuit capacitor life display	(0 to 100%)	1%	100%	251	
—	259	Main circuit capacitor life measuring	0, 1 (2, 3, 8, 9)	1	0	251	

Parameter	Remarks	Instruction Code			Control Mode-based Correspondence Table			Parameter		
		Read	Write	Extended	V/F	GP MFVC	AD MFVC	Copy	Clear	All clear
178		12	92	2	○	○	○	○	×	○
179		13	93	2	○	○	○	○	×	○
180		14	94	2	○	○	○	○	×	○
181		15	95	2	○	○	○	○	×	○
182		16	96	2	○	○	○	○	×	○
183		17	97	2	○	○	○	○	×	○
184		18	98	2	○	○	○	○	×	○
190		1E	9E	2	○	○	○	○	×	○
191		1F	9F	2	○	○	○	○	×	○
192		20	A0	2	○	○	○	○	×	○
232		28	A8	2	○	○	○	○	○	○
233		29	A9	2	○	○	○	○	○	○
234		2A	AA	2	○	○	○	○	○	○
235		2B	AB	2	○	○	○	○	○	○
236		2C	AC	2	○	○	○	○	○	○
237		2D	AD	2	○	○	○	○	○	○
238		2E	AE	2	○	○	○	○	○	○
239		2F	AF	2	○	○	○	○	○	○
240		30	B0	2	○	○	○	○	○	○
241		31	B1	2	○	○	○	○	○	○
244		34	B4	2	○	○	○	○	○	○
245		35	B5	2	○	×	○	○	○	○
246		36	B6	2	○	×	○	○	○	○
247		37	B7	2	○	×	○	○	○	○
249		39	B9	2	○	○	○	○	○	○
250		3A	BA	2	○	○	○	○	○	○
251		3B	BB	2	○	○	○	○	○	○
255		3F	BF	2	○	○	○	×	×	×
256		40	C0	2	○	○	○	×	×	×
257		41	C1	2	○	○	○	×	×	×
258		42	C2	2	○	○	○	×	×	×
259		43	C3	2	○	○	○	○	○	○

Function	Parameter	Name	Setting Range	Minimum Setting Increments	Initial Value	Refer to Page	Customer Setting
Power failure stop	261	Power failure stop selection	0, 1, 2	1	0	160	
	267	Terminal 4 input selection	0, 1, 2	1	0	168	
	268	Monitor decimal digits selection	0, 1, 9999	1	9999	146	
	269	Parameter for manufacturer setting. Do not set.					
Stop-on contact control	270	Stop-on contact control selection	0, 1	1	0	125	
	275	Stop-on contact excitation current low-speed multiplying factor	0 to 300%, 9999	0.1%	9999	125	
	276	PWM carrier frequency at stop-on contact	0 to 9, 9999	1	9999	125	
Brake sequence function	277	Stall prevention operation current switchover	0, 1	1	0	85	
	278	Brake opening frequency	0 to 30Hz	0.01Hz	3Hz	127	
	279	Brake opening current	0 to 200%	0.1%	130%	127	
	280	Brake opening current detection time	0 to 2s	0.1s	0.3s	127	
	281	Brake operation time at start	0 to 5s	0.1s	0.3s	127	
	282	Brake operation frequency	0 to 30Hz	0.01Hz	6Hz	127	
	283	Brake operation time at stop	0 to 5s	0.1s	0.3s	127	
Droop control	286	Droop gain	0 to 100%	0.1%	0%	247	
	287	Droop filter time constant	0 to 1s	0.01s	0.3s	247	
Digital input	292	Automatic acceleration/deceleration	0, 1, 7, 8, 11	1	0	107	
	293	Acceleration/deceleration separate selection	0 to 2	1	0	107	
	295	Magnitude of frequency change setting	0, 0.01, 0.10, 1.00, 10.00	0.01	0	262	
Analog output	298	Frequency search gain	0 to 32767, 9999	1	9999	154	
	299	Rotation direction detection selection at restarting	0, 1, 9999	1	0	154	
	300	BCD input bias	0 to 400Hz	0.01Hz	0	—	
	301	BCD input gain	0 to 400Hz, 9999	0.01Hz	60Hz	—	
	302	BIN input bias	0 to 400Hz	0.01Hz	0	—	
	303	BIN input gain	0 to 400Hz, 9999	0.01Hz	60Hz	—	
	304	Digital input and analog input compensation enable/disable selection	0, 1, 10, 11, 9999	1	9999	—	
Analog output	305	Read timing operation selection	0, 1, 10	1	0	—	
	306	Analog output signal selection	1 to 3, 5, 7 to 12, 14, 21, 24, 52, 53	1	2	—	
	307	Setting for zero analog output	0 to 100%	0.1%	0	—	
	308	Setting for maximum analog output	0 to 100%	0.1%	100	—	
	309	Analog output signal voltage/current switchover	0, 1, 10, 11	1	0	—	
	310	Analog meter voltage output selection	1 to 3, 5, 7 to 12, 14, 21, 24, 52, 53	1	2	—	
	311	Setting for zero analog meter voltage output	0 to 100%	0.1%	0	—	
	312	Setting for maximum analog meter voltage output	0 to 100%	0.1%	100	—	

Parameter	Remarks	Instruction Code			Control Mode-based Correspondence Table			Parameter		
		Read	Write	Extended	V/F	GP MFVC	AD MFVC	Copy	Clear	All clear
261		45	C5	2	○	○	○	○	○	○
267		4B	CB	2	○	○	○	○	×	○
268		4C	CC	2	○	○	○	○	○	○
269	Parameter for manufacturer setting. Do not set.									
270		4E	CE	2	×	○	○	○	○	○
275		53	D3	2	×	○	○	○	○	○
276		54	D4	2	×	○	○	○	○	○
277		55	D5	2	○	○	○	○	○	○
278		56	D6	2	×	○	○	○	○	○
279		57	D7	2	×	○	○	○	○	○
280		58	D8	2	×	○	○	○	○	○
281		59	D9	2	×	○	○	○	○	○
282		5A	DA	2	×	○	○	○	○	○
283		5B	DB	2	×	○	○	○	○	○
286		5E	DE	2	×	○	×	○	○	○
287		5F	DF	2	×	○	×	○	○	○
292		64	E4	2	○	○	○	○	○	○
293		65	E5	2	○	○	○	○	○	○
295		67	E7	2	○	○	○	○	○	○
298		6A	EA	2	○	○	○	○	×	○
299		6B	EB	2	○	○	○	○	○	○
300	[AX]	00	80	3	○	○	○	○	○	○
301	[AX]	01	81	3	○	○	○	○	○	○
302	[AX]	02	82	3	○	○	○	○	○	○
303	[AX]	03	83	3	○	○	○	○	○	○
304	[AX]	04	84	3	○	○	○	○	○	○
305	[AX]	05	85	3	○	○	○	○	○	○
306	[AY]	06	86	3	○	○	○	○	○	○
307	[AY]	07	87	3	○	○	○	○	○	○
308	[AY]	08	88	3	○	○	○	○	○	○
309	[AY]	09	89	3	○	○	○	○	○	○
310	[AY]	0A	8A	3	○	○	○	○	○	○
311	[AY]	0B	8B	3	○	○	○	○	○	○
312	[AY]	0C	8C	3	○	○	○	○	○	○

Function	Parameter	Name	Setting Range	Minimum Setting Increments	Initial Value	Refer to Page	Customer Setting
Digital output	313	DO0 output selection	0, 1, 3, 4, 7, 8, 11 to 16,	1	9999	—	
	314	DO1 output selection	20, 25, 26, 46, 47, 64,	1	9999	—	
	315	DO2 output selection	90, 91, 93, 95, 96, 98,	1	9999	—	
	316	DO3 output selection	99, 100, 101, 103,	1	9999	—	
	317	DO4 output selection	104, 107, 108,	1	9999	—	
	318	DO5 output selection	111 to 116, 120, 125,	1	9999	—	
	319	DO6 output selection	126, 146, 147, 164,	1	9999	—	
Relay output	320	RA1 output selection	190, 191, 193, 195,	1	9999	—	
	321	RA2 output selection	196, 198, 199, 9999	1	0	—	
	322	RA3 output selection	0, 1, 3, 4, 7, 8, 11 to 16,	1	1	—	
Analog output	323	AM0 0V adjustment	20, 25, 26, 46, 47, 64,	1	4	—	
	324	AM1 0mA adjustment	900 to 1100%	1%	1000	—	
—	329	Digital input unit selection	900 to 1100%	1%	1000	—	
RS-485 communication	338	Communication operation command source	0, 1, 2, 3	1	1	—	
	339	Communication frequency command source	0, 1	1	0	194	
	340	Communication startup mode selection	0, 1, 2	1	0	194	
	342	Communication EEPROM write selection	0, 1, 10	1	0	193	
	343	Communication error count	0, 1	1	0	207	
DeviceNet communication	345	DeviceNet address	—	1	0	220	
	346	DeviceNet baud rate	0 to 4095	1	63	—	
—	349	Communication reset selection	0 to 4095	1	132	—	
LoWorks communication	387	Initial communication delay time	0, 1	1	0	—	
	388	Send time interval at hart beat	0 to 120s	0.1s	0s	—	
	389	Minimum sending time at hart beat	0 to 999.8s	0.1s	0s	—	
	390	% setting reference frequency	0 to 999.8s	0.1s	0.5s	—	
	391	Receive time interval at hart beat	0 to 999.8s	0.1s	0.5s	—	
	392	Event driven detection width	1 to 400Hz	0.01Hz	60Hz	—	
	392	Event driven detection width	0.00 to 163.83%	0.01%	0%	—	
Second motor constant	450	Second applied motor	0, 1, 9999	1	9999	111	
Output	495	Remote output selection	0, 1, 10, 11	1	0	144	
	496	Remote output data 1	0 to 4095	1	0	144	
	497	Remote output data 2	0 to 4095	1	0	144	
Communication error	500	Communication error execution waiting time	0 to 999.8s	0.1s	0	—	
	501	Communication error occurrence count display	0	1	0	—	
—	502	Stop mode selection at communication error	0, 1, 2, 3	1	0	204, 220	

Parameter	Remarks	Instruction Code			Control Mode-based Correspondence Table			Parameter		
		Read	Write	Extended	V/F	GP MFVC	AD MFVC	Copy	Clear	All clear
313	[AY] [NC]	0D	8D	3	○	○	○	○	○	○
314	[AY] [NC]	0E	8E	3	○	○	○	○	○	○
315	[AY] [NC]	0F	8F	3	○	○	○	○	○	○
316	[AY]	10	90	3	○	○	○	○	○	○
317	[AY]	11	91	3	○	○	○	○	○	○
318	[AY]	12	92	3	○	○	○	○	○	○
319	[AY]	13	93	3	○	○	○	○	○	○
320	[AR]	14	94	3	○	○	○	○	○	○
321	[AR]	15	95	3	○	○	○	○	○	○
322	[AR]	16	96	3	○	○	○	○	○	○
323	[AY]	17	97	3	○	○	○	○	×	○
324	[AY]	18	98	3	○	○	○	○	×	○
329	[AX]	1D	9D	3	○	○	○	○	×	○
338		26	A6	3	○	○	○	○	○	○
339		27	A7	3	○	○	○	○	○	○
340		28	A8	3	○	○	○	○	○	○
342		2A	AA	3	○	○	○	○	○	○
343		2B	AB	3	○	○	○	×	×	×
345	[ND]	2D	AD	3	○	○	○	○	○	○
346	[ND]	2E	AE	3	○	○	○	○	○	○
349	[NC] [ND] [NL] [NP]	31	B1	3	○	○	○	○	○	○
387	[NL]	57	D7	3	○	○	○	○	○	○
388	[NL]	58	D8	3	○	○	○	○	○	○
389	[NL]	59	D9	3	○	○	○	○	○	○
390	[NL]	5A	DA	3	○	○	○	○	○	○
391	[NL]	5B	DB	3	○	○	○	○	○	○
392	[NL]	5C	DC	3	○	○	○	○	○	○
450		32	B2	4	○	○	○	○	○	○
495		5F	DF	4	○	○	○	○	○	○
496		60	E0	4	○	○	○	×	×	×
497		61	E1	4	○	○	○	×	×	×
500	[NC] [ND] [NL] [NP]	00	80	5	○	○	○	○	○	○
501	[NC] [ND] [NL] [NP]	01	81	5	○	○	○	×	○	○
502		02	82	5	○	○	○	○	○	○

Function	Parameter	Name	Setting Range	Minimum Setting Increments	Initial Value	Refer to Page	Customer Setting
Maintenance	503	Maintenance timer	0 (1 to 9998)	1	0	255	
	504	Maintenance timer alarm output set time	0 to 9998, 9999	1	9999	255	
CC-Link	541	Frequency command sign selection (CC-Link)	0, 1	1	0	—	
	542	Communication station number (CC-Link)	1 to 64	1	1	—	
	543	Baud rate selection (CC-Link)	0 to 4	1	0	—	
	544	CC-Link extended setting	0, 1, 12, 14, 18	1	0	—	
USB	547	USB communication station number	0 to 31	1	0	233	
	548	USB communication check time interval	0 to 999.8s, 9999	0.1s	9999	233	
Communication	549	Protocol selection	0, 1	1	0	220	
	550	NET mode operation command source selection	0, 2, 9999	1	9999	194	
	551	PU mode operation command source selection	2 to 4, 9999	1	9999	194	
Current average time monitor	555	Current average time	0.1 to 1.0s	0.1s	1s	256	
	556	Data output mask time	0.0 to 20.0s	0.1s	0s	256	
	557	Current average value monitor signal output reference current	0 to 500A	0.01A	Rated inverter current	256	
—	563	Energization time carrying-over times	(0 to 65535)	1	0	146	
—	564	Operating time carrying-over times	(0 to 65535)	1	0	146	
—	571	Holding time at a start	0.0 to 10.0s, 9999	0.1s	9999	105	
—	611	Acceleration time at a restart	0 to 3600s, 9999	0.1s	9999	154	
—	645	AM 0V adjustment	970 to 1200	1	1000	152	
—	653	Speed smoothing control	0 to 200%	0.1%	0	167	
—	665	Regeneration avoidance frequency gain	0 to 200%	0.1%	100	248	
—	800	Control method selection	20, 30	1	20	76, 79, 82	
—	859	Torque current	0 to 500A (0 to ****) , 9999 *5	0.01A (1) *5	9999	113	
Protective functions	872	Input phase loss protection selection	0, 1	1	1	164	
Regeneration avoidance function	882	Regeneration avoidance operation selection	0, 1, 2	1	0	248	
	883	Regeneration avoidance operation level	300 to 800V	0.1V	400VDC/780VDC *7	248	
	885	Regeneration avoidance compensation frequency limit value	0 to 10Hz, 9999	0.01Hz	6Hz	248	
	886	Regeneration avoidance voltage gain	0 to 200%	0.1%	100%	248	
Free parameter	888	Free parameter 1	0 to 9999	1	9999	258	
	889	Free parameter 2	0 to 9999	1	9999	258	

Parameter	Remarks	Instruction Code			Control Mode-based Correspondence Table			Parameter		
		Read	Write	Extended	V/F	GP MFVC	AD MFVC	Copy	Clear	All clear
503		03	83	5	○	○	○	×	×	×
504		04	84	5	○	○	○	○	×	○
541	NC	29	A9	5	○	○	○	○	○	○
542	NC	2A	AA	5	○	○	○	○	○	○
543	NC	2B	AB	5	○	○	○	○	○	○
544	NC	2C	AC	5	○	○	○	○	○	○
547		2F	AF	5	○	○	○	○	○	○
548		30	B0	5	○	○	○	○	○	○
549		31	B1	5	○	○	○	○	○	○
550		32	B2	5	○	○	○	○	○	○
551		33	B3	5	○	○	○	○	○	○
555		37	B7	5	○	○	○	○	○	○
556		38	B8	5	○	○	○	○	○	○
557		39	B9	5	○	○	○	○	○	○
563		3F	BF	5	○	○	○	×	×	×
564		40	C0	5	○	○	○	×	×	×
571		47	C7	5	○	○	○	○	○	○
611		0B	8B	6	○	○	○	○	○	○
645		2D	AD	6	○	○	○	○	×	○
653		35	B5	6	○	○	○	○	○	○
665		41	C1	6	○	○	○	○	○	○
800		00	80	8	×	○	○	○	○	○
859		3B	BB	8	×	○	○	○	×	○
872		48	C8	8	○	○	○	○	○	○
882		52	D2	8	○	○	○	○	○	○
883		53	D3	8	○	○	○	○	○	○
885		55	D5	8	○	○	○	○	○	○
886		56	D6	8	○	○	○	○	○	○
888		58	D8	8	○	○	○	○	×	×
889		59	D9	8	○	○	○	○	×	×



Function	Parameter	Name	Setting Range	Minimum Setting Increments	Initial Value	Refer to Page	Customer Setting
Calibration parameters	C0 (900) <sup>*6</sup>	FM terminal calibration	—	—	—	152	
	C1 (901) <sup>*6</sup>	AM terminal calibration	—	—	—	152	
	C2 (902) <sup>*6</sup>	Terminal 2 frequency setting bias frequency	0 to 400Hz	0.01Hz	0Hz	171	
	C3 (902) <sup>*6</sup>	Terminal 2 frequency setting bias	0 to 300%	0.1%	0%	171	
	125 (903) <sup>*6</sup>	Terminal 2 frequency setting gain frequency	0 to 400Hz	0.01Hz	60Hz	171	
	C4 (903) <sup>*6</sup>	Terminal 2 frequency setting gain	0 to 300%	0.1%	100%	171	
	C5 (904) <sup>*6</sup>	Terminal 4 frequency setting bias frequency	0 to 400Hz	0.01Hz	0Hz	171	
	C6 (904) <sup>*6</sup>	Terminal 4 frequency setting bias	0 to 300%	0.1%	20%	171	
	126 (905) <sup>*6</sup>	Terminal 4 frequency setting gain frequency	0 to 400Hz	0.01Hz	60Hz	171	
	C7 (905) <sup>*6</sup>	Terminal 4 frequency setting gain	0 to 300%	0.1%	100%	171	
—	C22 to C25 (922 to 923)	Parameter for manufacturer setting. Do not set.					
PU	990	PU buzzer control	0, 1	1	1	263	
	991	PU contrast adjustment	0 to 63	1	58	263	
Clear parameters Initial value change list	Pr.CL	Parameter clear	0, 1	1	0	264	
	ALLC	All parameter clear	0, 1	1	0	264	
	Er.CL	Faults history clear	0, 1	1	0	266	
	Pr.CH	Initial value change list	—	—	—	265	

\*1 Differ according to capacities.  
 6%: FR-E720-050 or less, FR-E740-026 or less  
 4%: FR-E720-080 to 175, FR-E740-040 to 095  
 3%: FR-E720-240 and 330, FR-E740-120 and 170  
 2%: FR-E720-470 and 600

\*2 Differ according to capacities.  
 5s: FR-E720-175 or less, FR-E740-095 or less  
 10s: FR-E720-240 and 330, FR-E740-120 and 170  
 15s: FR-E720-470 or less

\*3 Differ according to capacities.  
 6%: FR-E720-008 and 015  
 4%: FR-E720-030 to 330, FR-E740-016 to 170  
 2%: FR-E720-470 and 600

\*4 Write is disabled in the communication mode (network operation mode) from the PU connector.

\*5 The range differs according to the Pr. 71 setting.

\*6 The parameter number in parentheses is the one for use with the operation panel (PA02) for the FR-E500 series or parameter unit (FR-PU04/FR-PU07).

\*7 The initial value differs according to the voltage class. (200V class, 400V class)

Parameter	Remarks	Instruction Code			Control Mode-based Correspondence Table			Parameter		
		Read	Write	Extended	V/F	GP MFVC	AD MFVC	Copy	Clear	All clear
C0 (900)	AY	5C	DC	1	○	○	○	○	×	○
C1 (901)		5D	DD	1	○	○	○	○	×	○
C2 (902)		5E	DE	1	○	○	○	○	×	○
C3 (902)		5E	DE	1	○	○	○	○	×	○
125 (903)		5F	DF	1	○	○	○	○	×	○
C4 (903)		5F	DF	1	○	○	○	○	×	○
C5 (904)		60	E0	1	○	○	○	○	×	○
C6 (904)		60	E0	1	○	○	○	○	×	○
126 (905)		61	E1	1	○	○	○	○	×	○
C7 (905)		61	E1	1	○	○	○	○	×	○
—	C22 to C25 (922 to 923)	Parameter for manufacturer setting. Do not set.								
990		5A	DA	9	○	○	○	○	○	○
991		5B	DB	9	○	○	○	○	×	○
Pr.CL		—	—	—	—	—	—	—	—	—
ALLC		—	—	—	—	—	—	—	—	—
Er.CL		—	—	—	—	—	—	—	—	—
Pr.CH		—	—	—	—	—	—	—	—	—

<b>4.3</b>	<b>Control mode</b>	<b>75</b>
<hr/>		
4.3.1	Change the control method (Pr. 80, Pr. 81, Pr. 800) .....	76
<b>4.4</b>	<b>Adjust the output torque of the motor (current)</b>	<b>77</b>
<hr/>		
4.4.1	Manual torque boost (Pr. 0, Pr. 46) .....	77
4.4.2	Advance magnetic flux vector control (Pr. 71, Pr. 80, Pr. 81, Pr.89, Pr. 800) .....	79
4.4.3	General-purpose magnetic flux vector control (Pr. 71, Pr. 80, Pr. 81, Pr. 800) .....	82
4.4.4	Slip compensation (Pr. 245 to Pr. 247) .....	84
4.4.5	Stall prevention operation (Pr. 22, Pr. 23, Pr. 48, Pr. 66, Pr. 156, Pr. 157, Pr. 277) .....	85
<b>4.5</b>	<b>Limit the output frequency</b>	<b>89</b>
<hr/>		
4.5.1	Maximum/minimum frequency (Pr. 1, Pr. 2, Pr. 18).....	89
4.5.2	Avoid mechanical resonance points (frequency jumps) (Pr. 31 to Pr. 36).....	90
<b>4.6</b>	<b>Set V/F pattern</b>	<b>91</b>
<hr/>		
4.6.1	Base frequency, voltage (Pr. 3, Pr. 19, Pr. 47).....	91
4.6.2	Load pattern selection (Pr. 14) .....	93
<b>4.7</b>	<b>Frequency setting by external terminals</b>	<b>95</b>
<hr/>		
4.7.1	Operation by multi-speed operation (Pr. 4 to Pr. 6, Pr. 24 to Pr. 27, Pr. 232 to Pr. 239).....	95
4.7.2	Jog operation (Pr. 15, Pr. 16) .....	97
4.7.3	Remote setting function (Pr. 59).....	99
<b>4.8</b>	<b>Setting of acceleration/deceleration time and acceleration/ deceleration pattern</b>	<b>102</b>
<hr/>		
4.8.1	Setting of the acceleration and deceleration time (Pr. 7, Pr. 8, Pr. 20, Pr. 21, Pr. 44, Pr. 45, Pr. 147) .....	102
4.8.2	Starting frequency and start-time hold function (Pr. 13, Pr. 571).....	105
4.8.3	Acceleration/deceleration pattern (Pr. 29) .....	106
4.8.4	Shortest acceleration/deceleration (automatic acceleration/deceleration) (Pr. 61 to Pr. 63, Pr. 292, Pr. 293).....	107
<b>4.9</b>	<b>Selection and protection of a motor</b>	<b>109</b>
<hr/>		
4.9.1	Motor overheat protection (Electronic thermal O/L relay) (Pr. 9, Pr. 51) .....	109
4.9.2	Applied motor (Pr. 71, Pr. 450).....	111
4.9.3	To exhibit the best performance of the motor performance (offline auto tuning) (Pr. 71, Pr. 80 to Pr. 84, Pr. 90 to Pr. 94, Pr. 96, Pr. 859) .....	113
<b>4.10</b>	<b>Motor brake and stop operation</b>	<b>121</b>
<hr/>		
4.10.1	DC injection brake (Pr. 10 to Pr. 12).....	121
4.10.2	Selection of a regenerative brake (Pr. 30, Pr. 70) .....	122
4.10.3	Stop selection (Pr. 250) .....	124
4.10.4	Stop-on contact control function (Pr. 6, Pr. 48, Pr. 270, Pr. 275, Pr. 276) .....	125
4.10.5	Brake sequence function (Pr. 278 to Pr. 283, Pr. 292) .....	127
<b>4.11</b>	<b>Function assignment of external terminal and control</b>	<b>131</b>
<hr/>		
4.11.1	Input terminal function selection (Pr. 178 to Pr. 184).....	131

4.11.2	Inverter output shutoff signal (MRS signal, Pr. 17).....	133
4.11.3	Condition selection of function validity by second function selection signal (RT).....	134
4.11.4	Start signal operation selection (STF, STR, STOP signal, Pr. 250).....	135
4.11.5	Output terminal function selection (Pr. 190 to Pr. 192).....	137
4.11.6	Detection of output frequency (SU, FU signal, Pr. 41 to Pr. 43).....	141
4.11.7	Output current detection function (Y12 signal, Y13 signal, Pr. 150 to Pr. 153).....	142
4.11.8	Remote output selection (REM signal, Pr. 495 to Pr. 497).....	144
<b>4.12 Monitor display and monitor output signal</b>		<b>145</b>
4.12.1	Speed display and speed setting (Pr. 37).....	145
4.12.2	Monitor display selection of DU/PU and terminal AM (Pr. 52, Pr.158, Pr. 170, Pr. 171, Pr. 268, Pr. 563, Pr. 564).....	146
4.12.3	Reference of the terminal AM (analog voltage output) (Pr. 55, Pr. 56).....	151
4.12.4	Terminal AM calibration (calibration parameter Pr. 645, C1 (Pr.901)).....	152
<b>4.13 Operation selection at power failure and instantaneous power failure</b>		<b>154</b>
4.13.1	Automatic restart after instantaneous power failure/flying start (Pr. 30, Pr. 57, Pr. 58, Pr. 96, Pr. 162, Pr. 165, Pr. 298, Pr. 299, Pr. 611).....	154
4.13.2	Power-failure deceleration stop function (Pr. 261).....	160
<b>4.14 Operation setting at fault occurrence</b>		<b>162</b>
4.14.1	Retry function (Pr. 65, Pr. 67 to Pr. 69).....	162
4.14.2	Input/output phase loss protection selection (Pr. 251, Pr. 872).....	164
4.14.3	Earth (ground) fault detection at start (Pr. 249).....	164
<b>4.15 Energy saving operation</b>		<b>165</b>
4.15.1	Optimum excitation control (Pr. 60).....	165
<b>4.16 Motor noise, EMI measures, mechanical resonance</b>		<b>166</b>
4.16.1	PWM carrier frequency and soft-PWM control (Pr. 72, Pr. 240).....	166
4.16.2	Speed smoothing control (Pr. 653).....	167
<b>4.17 Frequency setting by analog input (terminal 2, 4)</b>		<b>168</b>
4.17.1	Analog input selection (Pr. 73, Pr. 267).....	168
4.17.2	Response level of analog input and noise elimination (Pr. 74).....	170
4.17.3	Bias and gain of frequency setting voltage (current) (Pr. 125, Pr. 126, Pr. 241, C2 (Pr. 902) to C7 (Pr. 905)).....	171
<b>4.18 Misoperation prevention and parameter setting restriction</b>		<b>176</b>
4.18.1	Reset selection/disconnected PU detection/PU stop selection (Pr. 75).....	176
4.18.2	Parameter write disable selection (Pr. 77).....	179
4.18.3	Reverse rotation prevention selection (Pr. 78).....	180
4.18.4	Extended parameter display and user group function (Pr. 160, Pr. 172 to Pr. 174).....	180
<b>4.19 Selection of operation mode and operation location</b>		<b>183</b>
4.19.1	Operation mode selection (Pr. 79).....	183
4.19.2	Operation mode at power-on (Pr. 79, Pr. 340).....	193
4.19.3	Start command source and frequency command source during communication	

operation (Pr. 338, Pr. 339, Pr. 550, Pr. 551) .....	194
<b>4.20 Communication operation and setting</b>	<b>200</b>
4.20.1 Wiring and configuration of PU connector .....	200
4.20.2 Initial settings and specifications of RS-485 communication (Pr. 117 to Pr. 120, Pr. 123, Pr. 124, Pr. 549) .....	203
4.20.3 Operation selection at communication error occurrence (Pr. 121, Pr. 122, Pr. 502) .....	204
4.20.4 Communication EEPROM write selection (Pr. 342) .....	207
4.20.5 Mitsubishi inverter protocol (computer link communication) .....	208
4.20.6 Modbus RTU communication specifications (Pr. 117, Pr. 118, Pr. 120, Pr. 122, Pr. 343, Pr. 502, Pr. 549) .....	220
4.20.7 USB communication (Pr. 547, Pr. 548) .....	233
<b>4.21 Special operation and frequency control</b>	<b>234</b>
4.21.1 PID control (Pr. 127 to Pr. 134) .....	234
4.21.2 Dancer control (Pr. 44, Pr. 45, Pr. 128 to Pr. 134) .....	241
4.21.3 Droop control (Pr. 286 to Pr. 287) .....	247
4.21.4 Regeneration avoidance function (Pr. 665, Pr. 882, Pr. 883, Pr. 885, Pr. 886) .....	248
<b>4.22 Useful functions</b>	<b>250</b>
4.22.1 Cooling fan operation selection (Pr. 244) .....	250
4.22.2 Display of the life of the inverter parts (Pr. 255 to Pr. 259) .....	251
4.22.3 Maintenance timer alarm (Pr. 503, Pr. 504) .....	255
4.22.4 Current average value monitor signal (Pr. 555 to Pr. 557) .....	256
4.22.5 Free parameter (Pr. 888, Pr. 889) .....	258
<b>4.23 Setting from the parameter unit and operation panel</b>	<b>259</b>
4.23.1 RUN key rotation direction selection (Pr. 40) .....	259
4.23.2 PU display language selection (Pr. 145) .....	259
4.23.3 Operation panel frequency setting/key lock operation selection (Pr. 161) .....	260
4.23.4 Magnitude of frequency change setting (Pr. 295) .....	262
4.23.5 Buzzer control (Pr. 990) .....	263
4.23.6 PU contrast adjustment (Pr. 991) .....	263
<b>4.24 Parameter clear/ All parameter clear</b>	<b>264</b>
<b>4.25 Initial value change list</b>	<b>265</b>
<b>4.26 Check and clear of the faults history</b>	<b>266</b>

## 4.3 Control mode

V/F control (initial setting), advanced magnetic flux vector control and general-purpose magnetic flux vector control are available with this inverter.

### (1) V/F Control

- It controls frequency and voltage so that the ratio of frequency (F) to voltage (V) is constant when changing frequency.

### (2) Advanced (general-purpose) magnetic flux vector control

- This control divides the inverter output current into an excitation current and a torque current by vector calculation and makes voltage compensation to flow a motor current which meets the load torque.
- General-purpose magnetic flux vector control is the same function as the FR-E500 series. For other cases, select advanced magnetic flux vector control.



#### POINT

If the following conditions are not satisfied, select V/F control since malfunction such as insufficient torque and uneven rotation may occur.

- The motor capacity should be equal to or one rank lower than the inverter capacity. (note that the capacity should be 0.1kW or more)
- Motor to be used is any of Mitsubishi standard motor, high efficiency motor (SF-JR, SF-HR 0.2kW or more) or Mitsubishi constant torque motor (SF-JRCA, SF-HRCA four-pole 0.4kW to 15kW). When using a motor other than the above (other manufacturer's motor), perform offline auto tuning without fail.
- Single-motor operation (one motor run by one inverter) should be performed.
- Wiring length from inverter to motor should be within 30m (98.4feet). (Perform offline auto tuning in the state where wiring work is performed when the wiring length exceeds 30m (98.4feet).)

## 4.3.1 Change the control method (Pr. 80, Pr. 81, Pr. 800)

Set when selecting the control method for advanced magnetic flux vector control and general-purpose magnetic flux vector control. The initial value is V/F control.

- Select a control mode using Pr. 800 Control method selection.

Parameter Number	Name	Initial Value	Setting Range	Description	
80	Motor capacity	9999	0.1 to 15kW	Set the applied motor capacity.	
			9999	V/F Control	
81	Number of motor poles	9999	2, 4, 6, 8, 10	Set the number of motor poles.	
			9999	V/F Control	
800	Control method selection	20	20	V/F	Advanced magnetic flux vector control *
			30	Control	General-purpose magnetic flux vector control *

\* Set a value other than "9999" in Pr. 80 and Pr. 81.

### (1) Setting of the motor capacity and the number of motor poles (Pr. 80, Pr. 81)

- Motor specifications (motor capacity and number of motor poles) must be set to select advanced magnetic flux vector control or general-purpose magnetic flux vector control.
- Set the motor capacity (kW) in Pr. 80 Motor capacity and set the number of motor poles in Pr. 81 Number of motor poles.

### (2) Selection of control method

- Select the inverter control method for V/F control, advanced magnetic flux vector control, and general-purpose magnetic flux vector control.

Pr. 80, 81	Pr. 800 Setting	Control Method
Other than 9999	20 (Pr. 800 initial value)	Advanced magnetic flux vector control
	30	General-purpose magnetic flux vector control
9999 (Pr. 80, Pr. 81 initial value)	— *	V/F control

\* Control method is V/F control regardless of the setting value of Pr. 800 when "9999" is set in Pr. 80 Motor capacity or Pr. 81 Number of motor poles.

### (3) Control method switching by external terminals (X18 signal)

- Use the V/F switchover signal (X18) to change the control method (V/F control-advanced magnetic flux vector control (general-purpose magnetic flux vector control)) with external terminal.
- Turn the X18 signal on to change the currently selected control method (advanced magnetic flux vector control or general-purpose magnetic flux vector control) to V/F control.

For the terminal used for X18 signal input, set "18" in any of Pr. 178 to Pr. 184 (input terminal function selection) to assign the function.

### REMARKS

When V/F control is selected by V/F switchover (X18 signal), second function is also selected at the same time. Control between V/F and advanced (general-purpose) magnetic flux can not be switched while the inverter is running. In case control is switched between V/F and advanced (general-purpose) magnetic flux, only second function is selected.

### NOTE

- Changing the terminal assignment using Pr. 178 to Pr. 184 (input terminal function selection) may affect the other functions. Make setting after confirming the function of each terminal.

### Parameters referred to

Advanced magnetic flux vector control Refer to page 79  
 General-purpose magnetic flux vector control Refer to page 82  
 Pr. 178 to Pr. 184 (input terminal function selection) Refer to page 131  
 Pr. 450 Second applied motor Refer to page 111  
 Pr. 44 Second acceleration/deceleration time, Pr. 45 Second deceleration time Refer to page 102  
 Pr. 46 Second torque boost Refer to page 77  
 Pr. 47 Second V/F (base frequency) Refer to page 91  
 Pr. 48 Second stall prevention operation current Refer to page 85  
 Pr. 51 Second electronic thermal O/L relay Refer to page 109

## 4.4 Adjust the output torque of the motor (current)

Purpose	Parameter that should be Set	Refer to Page
Set starting torque manually	Manual torque boost Pr. 0, Pr. 46	77
Automatically control output current according to load	Advanced magnetic flux vector control, general-purpose magnetic flux vector control Pr. 71, Pr. 80, Pr. 81, Pr. 89, Pr. 90, Pr. 450, Pr. 800	79, 82
Compensate for motor slip to secure low-speed torque	Slip compensation (V/F control and general-purpose magnetic flux vector control only) Pr. 245 to Pr. 247	84
Limit output current to prevent inverter trip	Stall prevention operation Pr. 22, Pr. 23, Pr. 66, Pr. 156, Pr. 157	85

### 4.4.1 Manual torque boost (Pr. 0, Pr. 46)

You can compensate for a voltage drop in the low-frequency range to improve motor torque reduction in the low-speed range.

- Motor torque in the low-frequency range can be adjusted to the load to increase the starting motor torque.
- Two kinds of start torque boosts can be changed by switching between terminals.

Parameter Number	Name	Initial Value	Setting Range	Description	
0	Torque boost	FR-E720-008 to 050 FR-E740-016 and 026	6%	0 to 30%	Set the output voltage at 0Hz as %.
		FR-E720-080 to 175 FR-E740-040 to 095	4%		
		FR-E720-240 and 330 FR-E740-120 and 170	3%		
		FR-E720-470 and 600	2%		
46 *	Second torque boost	9999	0 to 30%	Set the torque boost when the RT signal is on.	
			9999	Without second torque boost	

\* The above parameters can be set when Pr. 160 User group read selection = "0". (Refer to page 180)

#### (1) Starting torque adjustment

- On the assumption that Pr. 19 Base frequency voltage is 100%, set the output voltage at 0Hz in % to Pr. 0 (Pr. 46).
- Adjust the parameter little by little (about 0.5%), and check the motor status each time. If the setting is too large, the motor will overheat. The guideline is about 10% at the greatest.

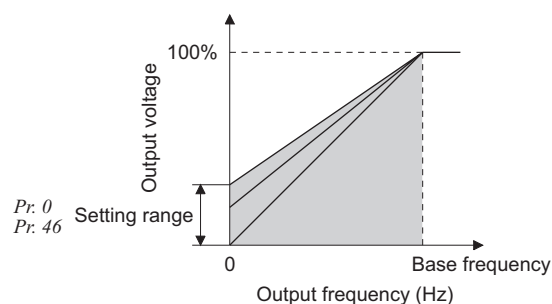

#### (2) Set two kinds of torque boosts (RT signal, Pr. 46)

- When you want to change torque boost according to applications, switch multiple motors with one inverter, etc., use *Second torque boost*.
- Pr. 46 *Second torque boost* is valid when the RT signal is on.
- For the terminal used for RT signal input, set "3" in any of Pr. 178 to Pr. 184 (*input terminal function selection*) to assign the function.

#### REMARKS

- The RT signal acts as the second function selection signal and makes the other second functions valid. (Refer to page 134)





### NOTE

- The amount of current flows in the motor may become large according to the conditions such as the motor characteristics, load, acceleration/deceleration time, wiring length, etc., resulting in an overcurrent trip (OL (overcurrent alarm) then E.OC1 (overcurrent trip during acceleration), overload trip (E.THM (motor overload trip), or E.THT (inverter overload trip).  
(When a fault occurs, release the start command, and decrease the *Pr. 0* setting 1% by 1% to reset.) (Refer to page 270.)
- The *Pr. 0*, *Pr. 46* settings are valid only when V/F control is selected.
- When using the inverter dedicated motor (constant torque motor) with the FR-E720-240 and 330, FR-E740-120 and 170, set torque boost value to 2%.  
When *Pr. 0* = "3%"(initial value), if *Pr. 71* value is changed to the setting for use with a constant-torque motor, the *Pr. 0* setting changes to 2%.
- Changing the terminal assignment using *Pr. 178* to *Pr. 184* (input terminal function selection) may affect the other functions. Make setting after confirming the function of each terminal.



### Parameters referred to

*Pr. 3* Base frequency, *Pr. 19* Base frequency voltage  Refer to page 91

*Pr. 71* Applied motor  Refer to page 111

*Pr. 178* to *Pr. 184* (input terminal function selection)  Refer to page 131



**4.4.2 Advance magnetic flux vector control (Pr. 71, Pr. 80, Pr. 81, Pr.89, Pr. 800)** 

Advanced magnetic flux vector control can be selected by setting the capacity, poles and type of the motor used in *Pr. 80 and Pr. 81*.

● Advanced magnetic flux vector control?

The low speed torque can be improved by providing voltage compensation so that the motor current which meets the load torque to flow. Output frequency compensation (slip compensation) is made so that the motor actual speed approximates a speed command value. Effective when load fluctuates drastically, etc.

When the FR-E500 series used for general-purpose magnetic flux vector control was replaced, select general-purpose magnetic flux vector control only when the same operation characteristic is necessary. (*Refer to page 82*)

Parameter Number	Name	Initial Value	Setting Range	Description
71	Applied motor	0	0, 1, 3 to 6, 13 to 16, 23, 24 40, 43, 44 50, 53, 54	By selecting a standard motor or constant-torque motor, thermal characteristic and motor constants of each motor are set.
80	Motor capacity	9999	0.1 to 15kW	Set the applied motor capacity.
			9999	V/F control
81	Number of motor poles	9999	2, 4, 6, 8, 10	Set the number of motor poles.
			9999	V/F control
89	Speed control gain (advanced magnetic flux vector)	9999	0 to 200%	Motor speed fluctuation due to load fluctuation is adjusted during advanced magnetic flux vector control. 100% is a referenced value.
			9999	Gain matching with the motor set in <i>Pr.71</i> .
800	Control method selection	20	20	Advanced magnetic flux vector control *
			30	General-purpose magnetic flux vector control * ( <i>Refer to page 82</i> )

*The above parameters can be set when Pr. 160 User group read selection = "0".(Refer to page 180)*

\* Set a value other than "9999" in *Pr. 80 and Pr. 81*.

**POINT**

If the following conditions are not satisfied, select V/F control since malfunction such as insufficient torque and uneven rotation may occur.

- The motor capacity should be equal to or one rank lower than the inverter capacity. (Note that the capacity should be 0.1kW or more.)
- Motor to be used is any of Mitsubishi standard motor, high efficiency motor (SF-JR, SF-HR 0.2kW or more) or Mitsubishi constant-torque motor (SF-JRCA, SF-HRCA four-pole 0.4kW to 15kW). When using a motor other than the above (other manufacturer's motor), perform offline auto tuning without fail.
- Single-motor operation (one motor run by one inverter) should be performed.
- The wiring length from inverter to motor should be within 30m (98.42feet). (Perform offline auto tuning in the state where wiring work is performed when the wiring length exceeds 30m (98.42feet).)
- Permissible wiring length between inverter and motor differs according to the inverter capacity and setting value of *Pr. 72 PWM frequency selection* (carrier frequency). *Refer to page 19* for the permissible wiring length.

## Adjust the output torque of the motor (current)

### <Selection method of advanced magnetic flux vector control>

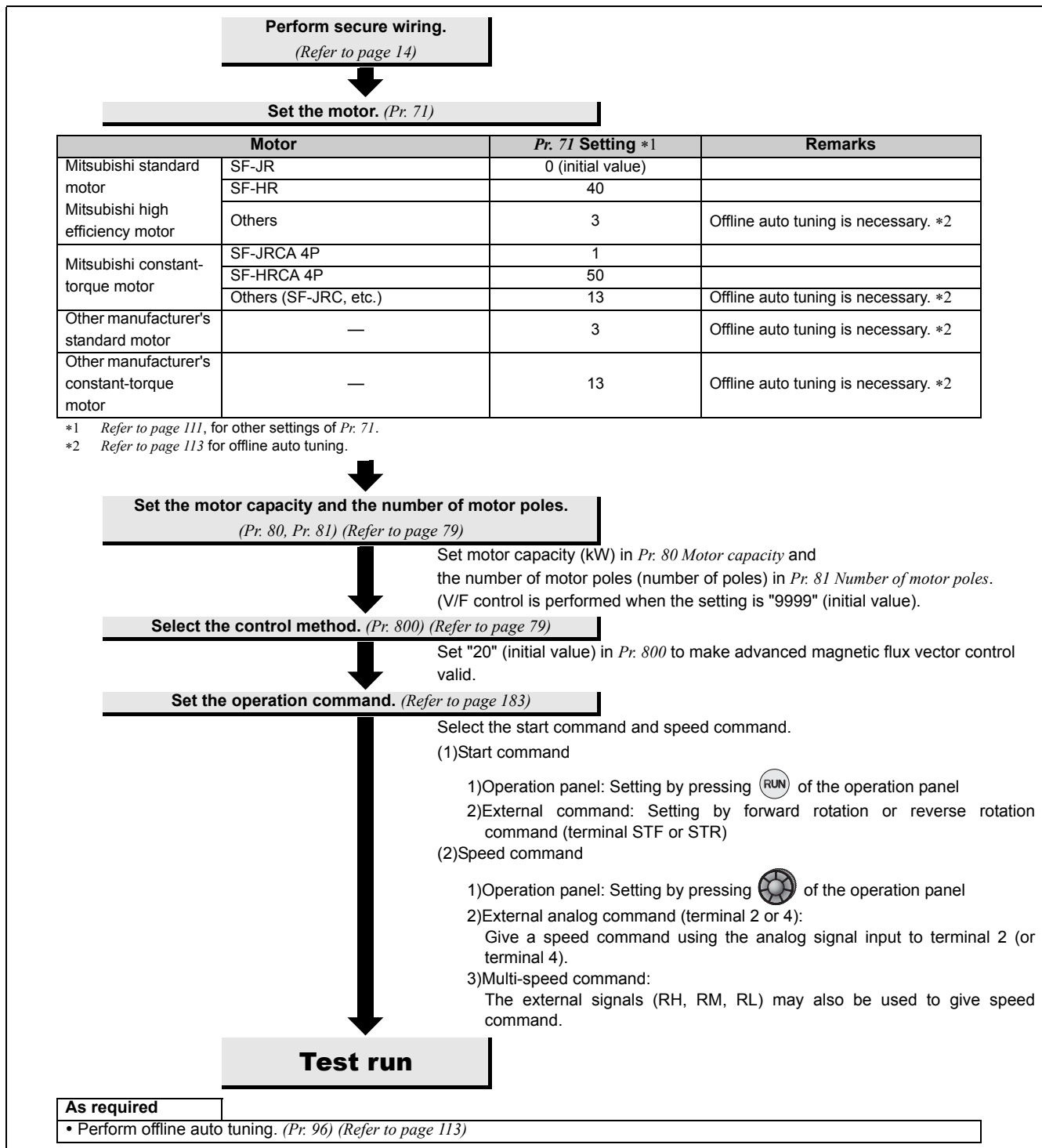

#### NOTE

- Uneven rotation slightly increases as compared to the V/F control. (It is not suitable for machines such as grinding machine and wrapping machine which requires less uneven rotation at low speed.)
- When a surge voltage suppression filter (FR-ASF-H/FR-BMF-H) is connected between the inverter and motor, output torque may decrease.)

### (1) Adjust the motor speed fluctuation at load fluctuation (*Pr. 89 Speed control gain (advanced magnetic flux vector)*)

The motor speed fluctuation at load fluctuation can be adjusted using *Pr. 89*. (It is useful when the speed command does not match the motor speed after the FR-E500 series inverter is replaced with the FR-E700 series inverter, etc.)

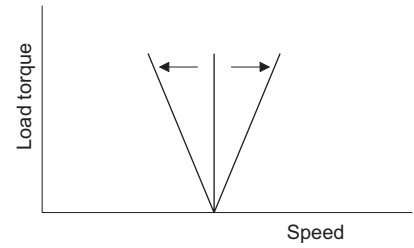

#### Parameters referred to

*Pr. 71, Pr. 450 Applied motor*  Refer to page 111

*Pr. 800 Control method selection*  Refer to page 76

## Adjust the output torque of the motor (current)

### 4.4.3 General-purpose magnetic flux vector control (Pr. 71, Pr. 80, Pr. 81, Pr. 800)

General-purpose magnetic flux vector control is the same function as the FR-E500 series.

Select this control when the same operation characteristic is necessary. For other cases, select advanced magnetic flux vector control. (Refer to page 79)

Parameter Number	Name	Initial Value	Setting Range	Description
71	Applied motor	0	0, 1, 3 to 6, 13 to 16, 23, 24 40, 43, 44 50, 53, 54	By selecting a standard motor or constant torque motor, thermal characteristic and motor constants of each motor are set.
80	Motor capacity	9999	0.1 to 15kW	Applied motor capacity.
			9999	V/F control
81	Number of motor poles	9999	2, 4, 6, 8, 10	Number of motor poles.
			9999	V/F control
800	Control method selection	20	20	Advanced magnetic flux vector control * (Refer to page 79)
			30	General-purpose magnetic flux vector control *

The above parameters can be set when Pr. 160 User group read selection = "0". (Refer to page 180)

\* Set a value other than "9999" in Pr. 80 and Pr. 81.



#### POINT



If the following conditions are not satisfied, select V/F control since malfunction such as insufficient torque and uneven rotation may occur.

- The motor capacity should be equal to or one rank lower than the inverter capacity. (note that the capacity should be 0.1kW or more)
- Motor to be used is any of Mitsubishi standard motor, high efficiency motor (SF-JR, SF-HR 0.2kW or more) or Mitsubishi constant torque motor (SF-JRCA, SF-HRCA four-pole 0.4kW to 15kW). When using a motor other than the above (other manufacturer's motor), perform offline auto tuning without fail.
- Single-motor operation (one motor run by one inverter) should be performed.
- The wiring length from inverter to motor should be within 30m (98.42feet). (Perform offline auto tuning in the state where wiring work is performed when the wiring length exceeds 30m (98.42feet).)
- Permissible wiring length between inverter and motor differs according to the inverter capacity and setting value of Pr. 72 PWM frequency selection (carrier frequency). Refer to page 19 for the permissible wiring length.

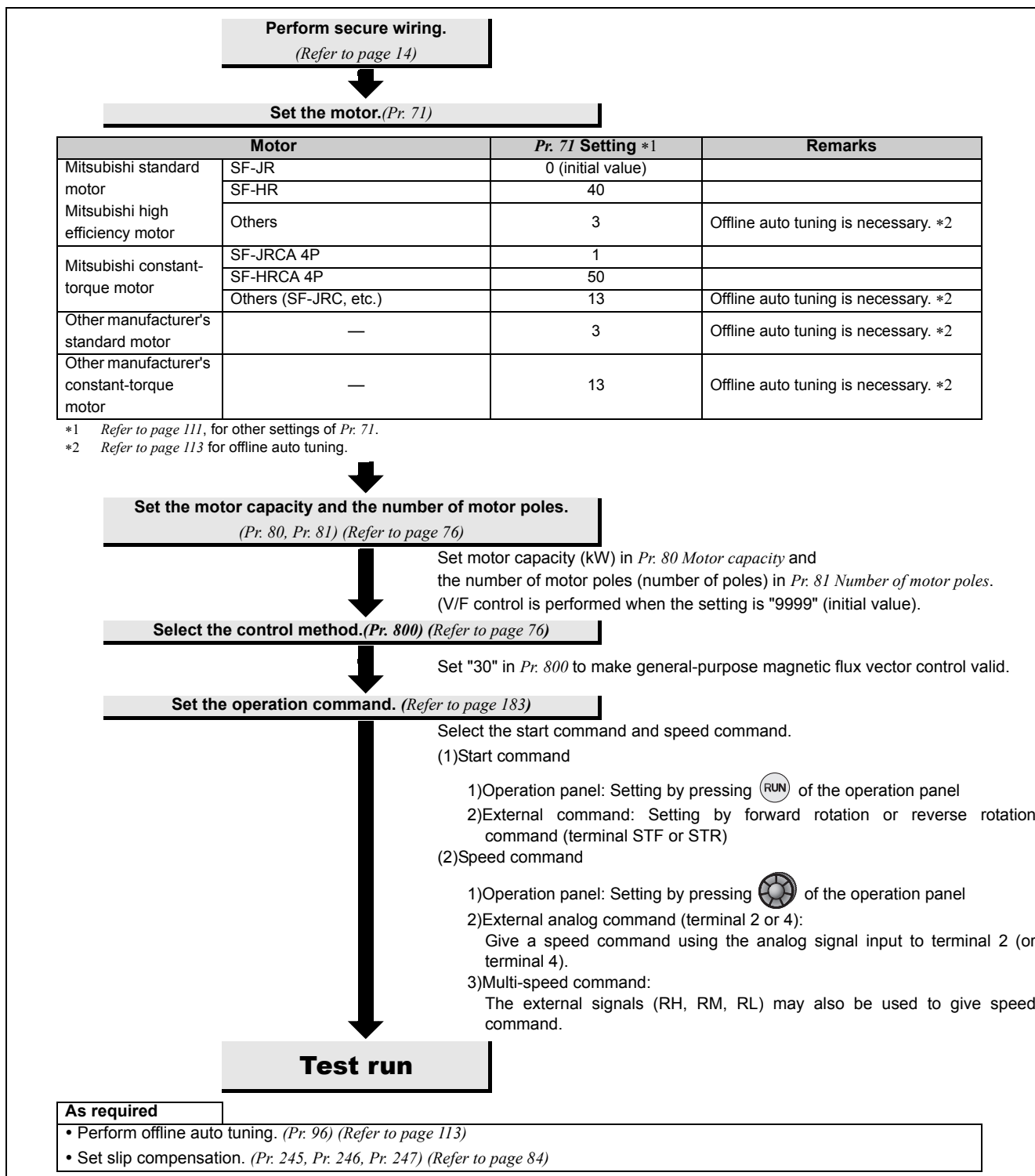
## &lt;Selection method of general-purpose magnetic flux vector control&gt;

**NOTE**

- Uneven rotation slightly increases as compared to the V/F control. (It is not suitable for machines such as grinding machine and wrapping machine which requires less uneven rotation at low speed.)
- When a surge voltage suppression filter (FR-ASF-H/FR-BMF-H) is connected between the inverter and motor, output torque may decrease.)

**Parameters referred to**Pr.3 Base frequency, Pr.19 Base frequency voltage  Refer to page 91Pr.71 Applied motor  Refer to page 111Pr.77 Parameter write selection  Refer to page 179

## Adjust the output torque of the motor (current)

### 4.4.4 Slip compensation (Pr. 245 to Pr. 247)

When V/F control or general-purpose magnetic flux vector control is performed, the inverter output current may be used to assume motor slip to keep the motor speed constant.

Parameter Number	Name	Initial Value	Setting Range	Description
245	Rated slip	9999	0.01 to 50%	Rated motor slip.
			0, 9999	No slip compensation
246	Slip compensation time constant	0.5s	0.01 to 10s	Slip compensation response time. When the value is made smaller, response will be faster. However, as load inertia is greater, a regenerative overvoltage fault (E.OV□) is more liable to occur.
247	Constant-power range slip compensation selection	9999	0	Slip compensation is not made in the constant power range (frequency range above the frequency set in Pr. 3)
			9999	Slip compensation is made in the constant power range.

The above parameters can be set when Pr. 160 User group read selection = "0". (Refer to page 180)

- Slip compensation is validated when the motor rated slip calculated by the following formula is set in Pr. 245. Slip compensation is not made when Pr. 245 = "0" or "9999".

$$\text{Rated slip} = \frac{\text{Synchronous speed at base frequency} - \text{rated speed}}{\text{Synchronous speed at base frequency}} \times 100[\%]$$





#### REMARKS

- When performing slip compensation, the output frequency may become greater than the set frequency. Set the Pr. 1 Maximum frequency value a little higher than the set frequency.
- Slip compensation is always valid when advanced magnetic flux vector control is selected, the Pr. 245 to Pr. 247 settings are invalid.



#### Parameters referred to

Pr. 1 Maximum frequency  Refer to page 89

Pr. 3 Base frequency  Refer to page 91

**4.4.5 Stall prevention operation (Pr. 22, Pr. 23, Pr. 48, Pr. 66, Pr. 156, Pr. 157, Pr. 277)**

This function monitors the output current and automatically changes the output frequency to prevent the inverter from coming to trip due to overcurrent, overvoltage, etc. In addition, simple torque limit which limits the output torque to the predetermined value can be selected.

It can also limit stall prevention and fast-response current limit operation during acceleration/deceleration, driving or regeneration.

- Stall prevention

If the output current exceeds the stall prevention operation level, the output frequency of the inverter is automatically varied to reduce the output current.

- Fast-response current limit

If the current exceeds the limit value, the output of the inverter is shut off to prevent an overcurrent.

- Torque limit

The inverter output frequency is controlled so that the output torque (torque current) will not exceed the stall prevention operation level (motor rated torque is referenced).

Parameter Number	Name	Initial Value	Setting Range	Description
22	Stall prevention operation level	150%	0	Stall prevention operation invalid
			0.1 to 200%	Set the current value to start the stall prevention operation.
23	Stall prevention operation level compensation factor at double speed	9999	0 to 200%	The stall operation level can be reduced when operating at a high speed above the rated frequency.
			9999	Constant according to Pr. 22.
48	Second stall prevention operation current	9999	0	Stall prevention operation invalid
			0.1 to 200%	Second stall prevention operation level
			9999	Same level as Pr. 22.
66	Stall prevention operation reduction starting frequency	60Hz	0 to 400Hz	Set the frequency at which the stall operation level is started to reduce.
156	Stall prevention operation selection	0	0 to 31, 100, 101	Select whether stall prevention operation and fast-response current limit operation will be performed or not.
157	OL signal output timer	0s	0 to 25s	Output start time of the OL signal output when stall prevention is activated.
			9999	Without the OL signal output
277	Stall prevention operation current switchover	0	0	Output current is the limit level
			1	Output torque (torque current) is the limit level

The above parameters can be set when Pr. 160 User group read selection = "0". (Refer to page 180)

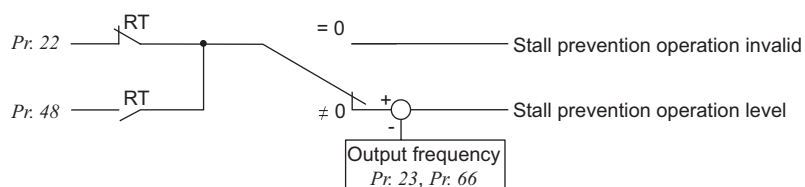
**(1) Block diagram**

## Adjust the output torque of the motor (current)

### (2) Setting of stall prevention operation level (Pr. 22)

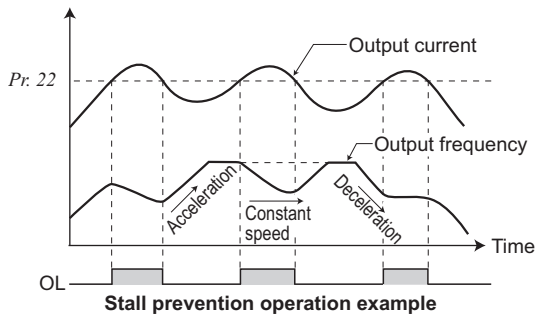

- Set in *Pr. 22* the percentage of the output current to the rated inverter current at which stall prevention operation will be performed. Normally set this parameter to 150% (initial value).
- Stall prevention operation stops acceleration (makes deceleration) during acceleration, makes deceleration during constant speed, and stops deceleration (makes acceleration) during deceleration.
- When stall prevention operation is performed, the OL signal is output.



#### NOTE

- If an overload status lasts long, an inverter trip (e.g. electronic thermal O/L relay (E.THM)) may occur.

### (3) A machine protection and load limit by torque limit (Pr. 277)

- When *Pr. 277 Stall prevention current switchover* = "1", torque limit can be set.
- When output torque (torque current) exceeds the stall prevention operation level, the output frequency is controlled to limit the output torque. For the stall prevention operation level at this time, the motor rated torque is defined as reference.



#### REMARKS

- When driving multiple motors with one inverter, torque limit does not function properly.
- Since magnetic flux decreases in the constant output range (*Pr. 3 Base frequency* or more), the inverter operate with lower torque than the stall prevention operation level.
- When torque limit is activated during regeneration, the output frequency is increased up to the maximum frequency.
- Torque limit does not function at 5Hz or less during deceleration.
- Note the following when using torque limit under V/F control.
  - (a) Capacity of the inverter and motor should be the same.
  - (b) Stall prevention operation level (torque limit level) is the rated torque reference of the motor whose capacity is equivalent to the inverter.
  - (c) When *Pr. 0 Torque boost* setting is large, torque limit is likely to occur in the low speed range.
  - (d) Use the advanced magnetic flux vector control when more appropriate torque limit is necessary.

### (4) Stall prevention operation output and output timing adjustment (OL signal, Pr. 157)

- When the output current exceeds the stall prevention operation level and stall prevention is activated, the stall prevention operation signal (OL signal) turns on for longer than 100ms. When the output current falls to or below the stall prevention operation level, the output signal turns off.
- Use *Pr. 157 OL signal output timer* to set whether the OL signal is output immediately or after a preset period of time.
- This operation is also performed when the regeneration avoidance function or  $\overline{OL}$  (overvoltage stall) is executed.
- For the Y13 signal, set "3 (positive logic) or 103 (negative logic)" in *Pr. 190 to Pr. 192 (output terminal function selection)* and assign functions to the output terminal.

Pr. 157 Setting	Description
0 (initial value)	Output immediately.
0.1 to 25	Output after the set time (s) has elapsed.
9999	Not output.

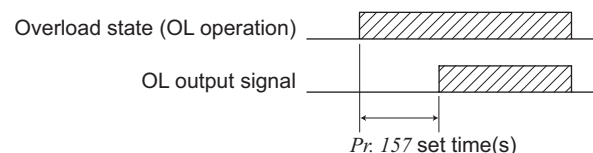

#### NOTE

- If the frequency has fallen to 1Hz by stall prevention operation and remains for 3s, a fault (E.OLT) appears to trip the inverter output.
- Changing the terminal assignment using *Pr. 190 to Pr. 192 (output terminal function selection)* may affect the other functions. Make setting after confirming the function of each terminal.



## (5) Setting of stall prevention operation in high frequency range (Pr. 22, Pr. 23, Pr. 66)

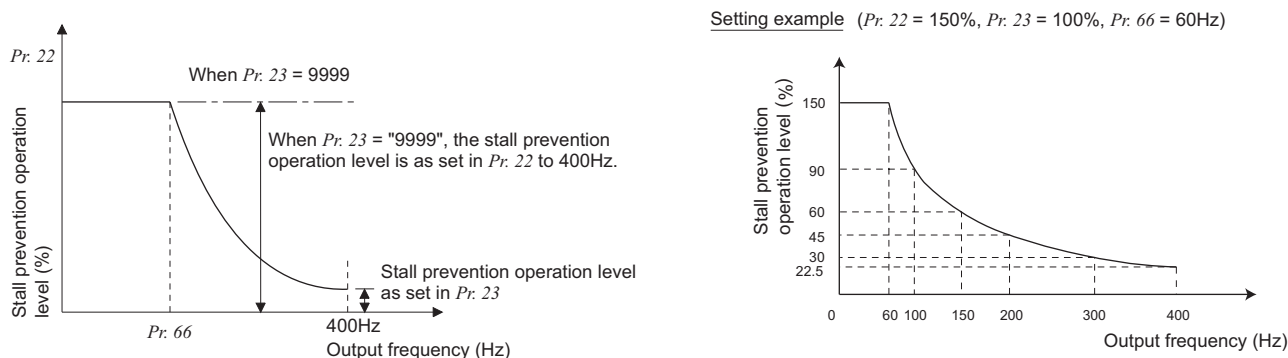

- During high-speed operation above the rated motor frequency, acceleration may not be made because the motor current does not increase. If operation is performed in a high frequency range, the current at motor lockup becomes smaller than the rated output current of the inverter, and the protective function (OL) is not executed even if the motor is at a stop. To improve the operating characteristics of the motor in this case, the stall prevention level can be reduced in the high frequency range. This function is effective for performing operation up to the high-speed range on a centrifugal separator etc. Normally, set 60Hz in Pr. 66 and 100% in Pr. 23.

- Formula for stall prevention operation level

$$\text{Stall prevention operation level in high frequency range (\%)} = A + B \times \left[ \frac{\text{Pr. 22} - A}{\text{Pr. 22} - B} \right] \times \left[ \frac{\text{Pr. 23} - 100}{100} \right]$$

$$\text{However, } A = \frac{\text{Pr. 66 (Hz)} \times \text{Pr. 22 (\%)}}{\text{Output frequency (Hz)}}, \quad B = \frac{\text{Pr. 66 (Hz)} \times \text{Pr. 22 (\%)}}{400\text{Hz}}$$

- By setting "9999" (initial value) in Pr. 23 Stall prevention operation level compensation factor at double speed, the stall prevention operation level is constant at the Pr. 22 setting up to 400Hz.

## (6) Set two types stall prevention operation levels (Pr. 48)

- Turning RT signal on makes Pr. 48 Second stall prevention operation current valid.
- For the terminal used for RT signal input, set "3" in any of Pr. 178 to Pr. 184 (input terminal function selection) to assign the function.



### NOTE

- Changing the terminal assignment using Pr. 178 to Pr. 184 (input terminal function selection) may affect the other functions. Make setting after confirming the function of each terminal.
- The RT signal acts as the second function selection signal and makes the other second functions valid. (Refer to page 134)

## Adjust the output torque of the motor (current)

### (7) Limit the stall prevention operation and fast-response current limit operation according to the operating status (Pr. 156)

• Refer to the following table and select whether fast-response current limit operation will be performed or not and the operation to be performed at OL signal output.

Pr. 156 Setting	Fast-Response Current Limit ○: Activated ●: Not activated	Stall Prevention Operation Selection ○: Activated ●: Not activated			OL Signal Output ○: Operation continued ●: Operation not continued *1	Pr. 156 Setting	Fast-Response Current Limit ○: Activated ●: Not activated	Stall Prevention Operation Selection ○: Activated ●: Not activated			OL Signal Output ○: Operation continued ●: Operation not continued *1
		Acceleration	Constant speed	Deceleration				Acceleration	Constant speed	Deceleration	
0 (initial value)	○	○	○	○	○	16	○	○	○	○	●
1	●	○	○	○	○	17	●	○	○	○	●
2	○	●	○	○	○	18	○	●	○	○	●
3	●	●	○	○	○	19	●	●	○	○	●
4	○	○	●	○	○	20	○	○	●	○	●
5	●	○	●	○	○	21	●	○	●	○	●
6	○	●	●	○	○	22	○	●	●	○	●
7	●	●	●	○	○	23	●	●	●	○	●
8	○	○	○	●	○	24	○	○	○	●	●
9	●	○	○	●	○	25	●	○	○	●	●
10	○	●	○	●	○	26	○	●	○	●	●
11	●	●	○	●	○	27	●	●	○	●	●
12	○	○	○	●	○	28	○	○	○	●	●
13	●	○	●	●	○	29	●	○	●	●	●
14	○	●	●	●	— *2	30	○	●	●	●	— *2
15	●	●	●	●	— *2	31	●	●	●	●	— *2
100 *3	Power driving	○	○	○	○	101 *3	Power driving	●	○	○	○
	Regeneration	●	●	●	— *2		Regeneration	●	●	●	●

\*1 When "Operation not continued for OL signal output" is selected, the **E.O.L.T** fault (stopped by stall prevention) is displayed and operation stopped.

\*2 Since stall prevention is not activated, OL signal and E.O.L.T are not output.

\*3 The settings "100" and "101" allow operations to be performed in the driving and regeneration modes, respectively. The setting "101" disables the fast-response current limit in the driving mode.



#### NOTE

- When the load is heavy or the acceleration/deceleration time is short, stall prevention is activated and acceleration/deceleration may not be made according to the preset acceleration/deceleration time. Set Pr. 156 and stall prevention operation level to the optimum values.
- In vertical lift applications, make setting so that the fast-response current limit is not activated. Torque may not be produced, causing a load drop due to gravity.

## ⚠ CAUTION

⚠ Do not set a small value as the stall prevention operation current. Otherwise, torque generated will reduce.

⚠ Test operation must be performed.

Stall prevention operation during acceleration may increase the acceleration time.

Stall prevention operation performed during constant speed may cause sudden speed changes.

Stall prevention operation during deceleration may increase the deceleration time, increasing the deceleration distance.



#### Parameters referred to

- Pr. 3 Base frequency Refer to page 91
- Pr. 178 to Pr. 184 (input terminal function selection) Refer to page 131
- Pr. 190 to Pr. 192 (output terminal function selection) Refer to page 137

## 4.5 Limit the output frequency

Purpose	Parameter that should be Set		Refer to Page
Set upper limit and lower limit of output frequency	Maximum/minimum frequency	Pr. 1, Pr. 2, Pr. 18	89
Perform operation by avoiding mechanical resonance points	Frequency jump	Pr. 31 to Pr. 36	90

### 4.5.1 Maximum/minimum frequency (Pr. 1, Pr. 2, Pr. 18)

Motor speed can be limited.

Clamp the upper and lower limits of the output frequency.

Parameter Number	Name	Initial Value	Setting Range	Description
1	Maximum frequency	120Hz	0 to 120Hz	Upper limit of the output frequency.
2	Minimum frequency	0Hz	0 to 120Hz	Lower limit of the output frequency.
18 *	High speed maximum frequency	120Hz	120 to 400Hz	Set when performing the operation at 120Hz or more.

\* The above parameters can be set when Pr. 160 User group read selection = "0". (Refer to page 180)

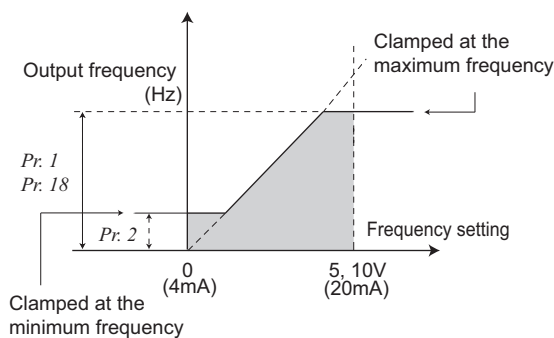

#### (1) Set maximum frequency

- Use Pr. 1 Maximum frequency to set the maximum frequency. If the frequency of the frequency command entered is higher than the setting, the output frequency is clamped at the maximum frequency.
- When you want to perform operation above 120Hz, set the upper limit of the output frequency to Pr. 18 High speed maximum frequency. (When Pr. 18 is set, Pr. 1 automatically switches to the frequency of Pr. 18. Also, when Pr. 1 is set, Pr. 18 is automatically changed to the frequency set in Pr. 1.

#### REMARKS

- When performing operation above 60Hz using the frequency setting analog signal, change Pr. 125 (Pr. 126) (frequency setting gain).

#### (2) Set minimum frequency

- Use Pr. 2 Minimum frequency to set the minimum frequency.
- If the set frequency is less than Pr. 2, the output frequency is clamped at Pr. 2 (will not fall below Pr. 2).

#### REMARKS

- When Pr. 15 JOG frequency is equal to or less than Pr. 2, the Pr. 15 setting has precedence over the Pr. 2 setting.
- When stall prevention is activated to decrease the output frequency, the output frequency may drop to Pr. 2 or below.

## CAUTION

⚠ Note that when Pr. 2 is set to any value equal to or more than Pr. 13 Starting frequency, simply turning on the start signal will run the motor at the preset frequency according to the set acceleration time even if the command frequency is not input.



#### Parameters referred to

Pr. 13 Starting frequency Refer to page 105

Pr. 15 Jog frequency Refer to page 97

Pr. 125 Terminal 2 frequency setting gain frequency, Pr. 126 Terminal 4 frequency setting gain frequency Refer to page 171

## 4.5.2 Avoid mechanical resonance points (frequency jumps) (Pr. 31 to Pr. 36)

When it is desired to avoid resonance attributable to the natural frequency of a mechanical system, these parameters allow resonant frequencies to be jumped.

Parameter Number	Name	Initial Value	Setting Range	Description
31	Frequency jump 1A	9999	0 to 400Hz, 9999	1A to 1B, 2A to 2B, 3A to 3B is frequency jumps 9999: Function invalid
32	Frequency jump 1B	9999	0 to 400Hz, 9999	
33	Frequency jump 2A	9999	0 to 400Hz, 9999	
34	Frequency jump 2B	9999	0 to 400Hz, 9999	
35	Frequency jump 3A	9999	0 to 400Hz, 9999	
36	Frequency jump 3B	9999	0 to 400Hz, 9999	

The above parameters can be set when Pr. 160 User group read selection = "0". (Refer to page 180)

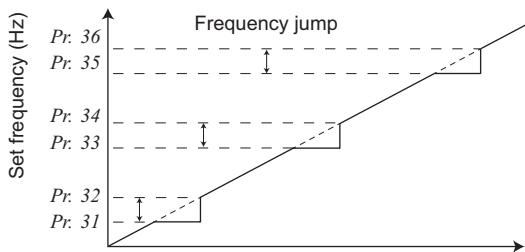

- Up to three areas may be set, with the jump frequencies set to either the top or bottom point of each area.
- The value set to 1A, 2A or 3A is a jump point and operation in the jump zone is performed at these frequencies.

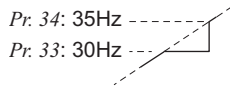

**Example 1**

To fix the frequency to 30Hz in the range 30Hz to 35Hz, set 35Hz in Pr. 34 and 30Hz in Pr. 33.

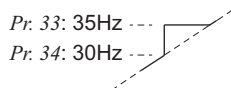

**Example 2**

To jump the frequency to 35Hz in the range 30Hz to 35Hz, set 35Hz in Pr. 33 and 30Hz in Pr. 34.



### NOTE

During acceleration/deceleration, the running frequency within the set area is valid.

## 4.6 Set V/F pattern

Purpose	Parameter that should be Set		Refer to Page
Set motor ratings	Base frequency, Base frequency voltage	Pr. 3, Pr. 19, Pr. 47	91
Select a V/F pattern according to applications.	Load pattern selection	Pr. 14	93

### 4.6.1 Base frequency, voltage (Pr. 3, Pr. 19, Pr. 47)

Used to adjust the inverter outputs (voltage, frequency) to the motor rating.

Parameter Number	Name	Initial Value	Setting Range	Description
3	Base frequency	60Hz	0 to 400Hz	Rated motor frequency. (50Hz/60Hz)
19 *	Base frequency voltage	9999	0 to 1000V	Base voltage.
			8888	95% of power supply voltage
			9999	Same as power supply voltage
47 *	Second V/F (base frequency)	9999	0 to 400Hz	Base frequency when the RT signal is on.
			9999	Second V/F invalid

\* The above parameters can be set when Pr. 160 User group read selection = "0". (Refer to page 180)

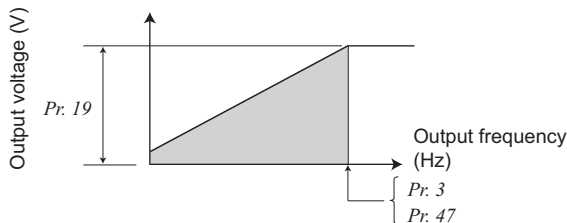

#### (1) Base frequency setting (Pr. 3)

- When operating a standard motor, generally set the rated frequency of the motor to Pr. 3 Base frequency. When running the motor using commercial power supply-inverter switch-over operation, set Pr. 3 to the same value as the power supply frequency.
- If the frequency given on the motor rating plate is "50Hz" only, always set to "50Hz". Leaving the base frequency unchanged from "60Hz" may make the voltage too low and the torque insufficient. It may result in an inverter trip due to overload. Special care must be taken when "1" (variable torque load) is set in Pr. 14 Load pattern selection .
- When using the Mitsubishi constant-torque motor, set Pr. 3 to 60Hz.

#### (2) Set two kinds of base frequencies (Pr. 47)

- When you want to change the base frequency when switching two types of motors with one inverter, use the Pr. 47 Second V/F (base frequency).
- Pr. 47 Second V/F (base frequency) is valid when the RT signal is on. Set "3" in any of Pr. 178 to Pr. 184 (input terminal function selection) and assign the RT signal.

#### REMARKS

- The RT signal acts as the second function selection signal and makes the other second functions valid. (Refer to page 134)

### (3) Base frequency voltage setting (Pr. 19)

- Use Pr. 19 Base frequency voltage to set the base voltage (e.g. rated motor voltage).
- If the setting is less than the power supply voltage, the maximum output voltage of the inverter is as set in Pr. 19.
- Pr. 19 can be utilized in the following cases.
  - (a) When regeneration is high (e.g. continuous regeneration)

During regeneration, the output voltage becomes higher than the reference and may cause an overcurrent trip (E.O.C□) due to an increased motor current.
  - (b) When power supply voltage variation is large

When the power supply voltage exceeds the rated voltage of the motor, speed variation or motor overheat may be caused by excessive torque or increased motor current.









#### NOTE

- When advanced magnetic flux vector control or general-purpose magnetic flux vector control is selected, Pr. 3, Pr. 47 and Pr. 19 are invalid and Pr. 83 and Pr. 84 are valid.

Note that Pr. 3 or Pr. 47 value is made valid as inflection points of S-pattern when Pr. 29 Acceleration/deceleration pattern selection = "1" (S-pattern acceleration/deceleration A).
- Changing the terminal assignment using Pr. 178 to Pr. 184 (input terminal function selection) may affect the other functions. Make setting after confirming the function of each terminal.



#### Parameters referred to

- Pr. 14 Load pattern selection  Refer to page 93
- Pr. 29 Acceleration/deceleration pattern selection  Refer to page 106
- Pr. 83 Motor rated voltage, Pr. 84 Rated motor frequency  Refer to page 113
- Pr. 178 to Pr. 184 (input terminal function selection)  Refer to page 131
- General-purpose magnetic flux vector control  Refer to page 82
- Advanced magnetic flux vector control  Refer to page 79

## 4.6.2 Load pattern selection (Pr. 14)

You can select the optimum output characteristic (V/F characteristic) for the application and load characteristics.

Parameter Number	Name	Initial Value	Setting Range	Description
14	Load pattern selection	0	0	For constant torque load
			1	For variable torque load
			2	For constant torque elevators (at reverse rotation boost of 0%)
			3	For constant torque elevators (at reverse rotation boost of 0%)

The above parameters can be set when Pr. 160 User group read selection = "0". (Refer to page 180)

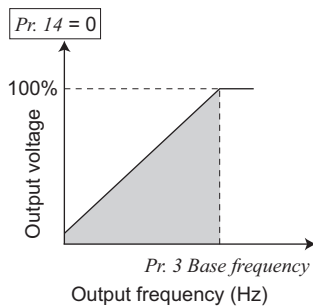

### (1) Constant-torque load application (setting "0", initial value)

- At or less than the base frequency, the output voltage varies linearly with the output frequency.
- Set this value when driving the load whose load torque is constant even if the speed varies, e.g. conveyor, cart or roll drive.



### POINT

If the load is a fan or pump, select for constant-torque load (setting "0") in any of the following cases.

- When a blower of large inertia moment (J) is accelerated in a short time
- For constant-torque load such as rotary pump or gear pump
- When load torque increases at low speed, e.g. screw pump

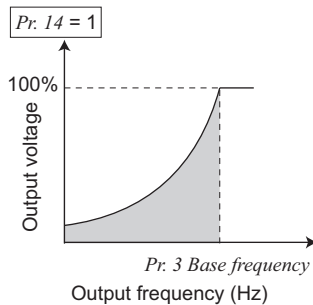

### (2) Variable-torque load application (setting "1")

- At or less than the base frequency, the output voltage varies with the output frequency in a square curve.
- Set this value when driving the load whose load torque varies in proportion to the square of the speed, e.g. fan or pump.

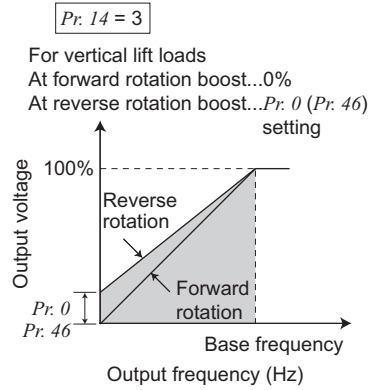
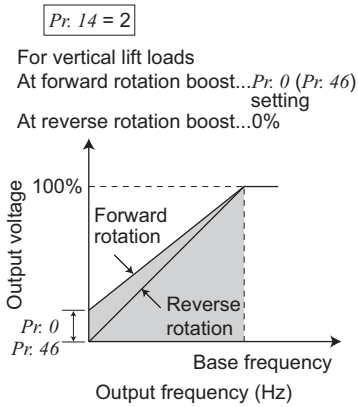

### (3) Constant-torque load application (setting "2, 3")

- Set "2" when a vertical lift load is fixed as power driving load at forward rotation and regenerative load at reverse rotation.
- Pr. 0 Torque boost is valid during forward rotation and torque boost is automatically changed to "0%" during reverse rotation. Pr. 46 Second torque boost is made valid when the RT signal turns on.
- Set "3" for an elevated load that is in the driving mode during reverse rotation and in the regenerative load mode during forward rotation according to the load weight, e.g. counterweight system.
- For the RT signal, set "3" in any of Pr. 178 to Pr. 184 (input terminal function selection) to assign the function.

### REMARKS

- When torque is continuously regenerated as vertical lift load, it is effective to set the rated voltage in Pr. 19 Base frequency voltage to prevent trip due to current at regeneration.
- In addition, when the RT signal is on, the other second functions are also valid.

### NOTE

- Load pattern selection does not function under advanced magnetic flux vector control and general-purpose magnetic flux vector control.
- Changing the terminal assignment using Pr. 178 to Pr. 184 (input terminal function selection) may affect the other functions. Make setting after confirming the function of each terminal.

### Parameters referred to

- Pr. 0, Pr. 46 (Torque boost) Refer to page 77
- Pr. 3 Base frequency Refer to page 91
- Pr. 178 to Pr. 184 (input terminal function selection) Refer to page 131
- General-purpose magnetic flux vector control Refer to page 79
- Advanced magnetic flux vector control Refer to page 79



## 4.7 Frequency setting by external terminals

Purpose	Parameter that should be Set		Refer to Page
Make frequency setting by combination of terminals	Multi-speed operation	Pr. 4 to Pr. 6, Pr. 24 to Pr. 27, Pr. 232 to Pr. 239	95
Perform jog operation	Jog operation	Pr. 15, Pr. 16	97
Infinitely variable speed setting by terminals	Remote setting function	Pr. 59	99

### 4.7.1 Operation by multi-speed operation (Pr. 4 to Pr. 6, Pr. 24 to Pr. 27, Pr. 232 to Pr. 239)

Can be used to change the preset speed in the parameter with the contact signals.

Any speed can be selected by merely turning on-off the contact signals (RH, RM, RL, REX signals).

Parameter Number	Name	Initial Value	Setting Range	Description
4	Multi-speed setting (high speed)	60Hz	0 to 400Hz	Frequency when RH turns on
5	Multi-speed setting (middle speed)	30Hz	0 to 400Hz	Frequency when RM turns on.
6	Multi-speed setting (low speed)	10Hz	0 to 400Hz	Frequency when RL turns on.
24 *	Multi-speed setting (speed 4)	9999	0 to 400Hz, 9999	Frequency from 4 speed to 15 speed can be set according to the combination of the RH, RM, RL and REX signals. 9999: not selected
25 *	Multi-speed setting (speed 5)	9999	0 to 400Hz, 9999	
26 *	Multi-speed setting (speed 6)	9999	0 to 400Hz, 9999	
27 *	Multi-speed setting (speed 7)	9999	0 to 400Hz, 9999	
232 *	Multi-speed setting (speed 8)	9999	0 to 400Hz, 9999	
233 *	Multi-speed setting (speed 9)	9999	0 to 400Hz, 9999	
234 *	Multi-speed setting (speed 10)	9999	0 to 400Hz, 9999	
235 *	Multi-speed setting (speed 11)	9999	0 to 400Hz, 9999	
236 *	Multi-speed setting (speed 12)	9999	0 to 400Hz, 9999	
237 *	Multi-speed setting (speed 13)	9999	0 to 400Hz, 9999	
238 *	Multi-speed setting (speed 14)	9999	0 to 400Hz, 9999	
239 *	Multi-speed setting (speed 15)	9999	0 to 400Hz, 9999	

The above parameters allow its setting to be changed during operation in any operation mode even if "0" (initial value) is set in Pr. 77 Parameter write selection.

\* The above parameters can be set when Pr. 160 User group read selection = "0". (Refer to page 180)

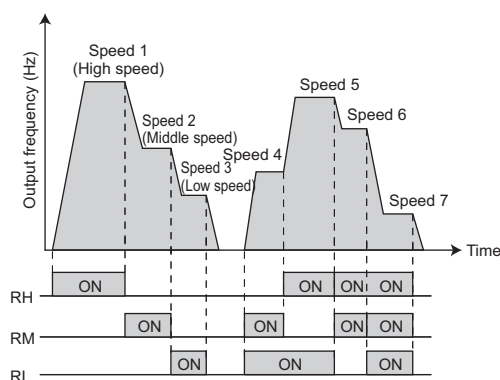

#### (1) 3-speed setting (Pr. 4 to Pr. 6)

- The inverter operates at frequencies set in Pr. 4 when RH signal is on, Pr. 5 when RM signal is on and Pr. 6 when RL signal is on.

#### REMARKS

- For multi-speed setting, if two or three speeds are simultaneously selected, priority is given to the set frequency of the lower signal.  
For example, when the RH and RM signals turn on, the RM signal (Pr. 5) has a higher priority.
- The RH, RM, RL signals are assigned to the terminal RH, RM, RL in the initial setting. By setting "0 (RL)", "1 (RM)", "2 (RH)" in any of Pr. 178 to Pr. 184 (input terminal function selection), you can assign the signals to other terminals.

## (2) Multi-speed setting for 4 or more speeds (Pr. 24 to Pr. 27, Pr. 232 to Pr. 239)

- Frequency from 4 speed to 15 speed can be set according to the combination of the RH, RM, RL and REX signals. Set the running frequencies in Pr. 24 to Pr. 27, Pr. 232 to Pr. 239 (In the initial value setting, speed 4 to speed 15 are unavailable).
- For the terminal used for REX signal input, set "8" in any of Pr. 178 to Pr. 184 (input terminal function selection) to assign the function.

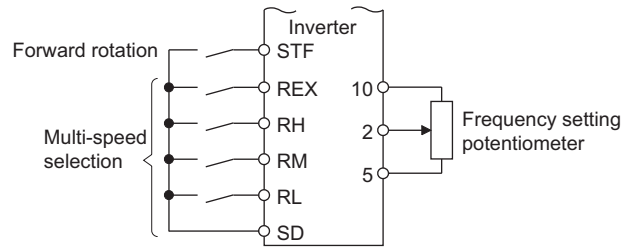
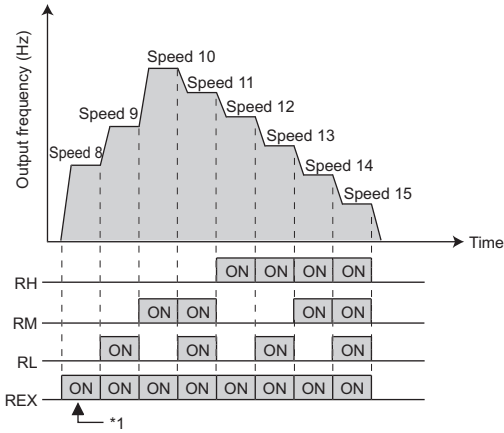

Multi-speed operation connection example

\*1 When "9999" is set in Pr. 232 Multi-speed setting (speed 8), the frequency changes to 0Hz when RH, RM and RL are turned off and REX is turned on.

### REMARKS

- The priorities of the frequency commands by the external signals are "jog operation > multi-speed operation > terminal 4 analog input > terminal 2 analog input".  
(Refer to page 171 for the frequency command by analog input)
- Valid in the external operation mode or PU/external combined operation mode (Pr. 79 = "3" or "4").
- Multi-speed parameters can also be set in the PU or external operation mode.
- Pr. 24 to Pr. 27 and Pr. 232 to Pr. 239 settings have no priority between them.
- When Pr. 59 Remote function selection ≠ "0", multi-speed setting is invalid as RH, RM and RL signals are remote setting signals.

### NOTE

- Changing the terminal assignment using Pr. 178 to Pr. 184 (input terminal function selection) may affect the other functions. Make setting after confirming the function of each terminal.

### Parameters referred to

- Pr. 15 Jog frequency Refer to page 97
- Pr. 59 Remote function selection Refer to page 99
- Pr. 79 Operation mode selection Refer to page 183
- Pr. 178 to Pr. 184 (input terminal function selection) Refer to page 131

### 4.7.2 Jog operation (Pr. 15, Pr. 16)

You can set the frequency and acceleration/deceleration time for jog operation. Jog operation can be performed in either of the external and the PU operation mode.

This operation can be used for conveyor positioning, test operation, etc.

Parameter Number	Name	Initial Value	Setting Range	Description
15	Jog frequency	5Hz	0 to 400Hz	Frequency for jog operation.
16	Jog acceleration/deceleration time	0.5s	0 to 3600/ 360s *	Acceleration/deceleration time for jog operation. As the acceleration/deceleration time, set the time taken to reach the frequency (initial value is 60Hz) set in Pr. 20 Acceleration/deceleration reference frequency. Acceleration/deceleration time can not be set separately.

These parameters are displayed as simple mode parameter only when the parameter unit (FR-PU04/FR-PU07) is connected. When the parameter unit is not connected, the above parameters can be set when Pr. 160 User group read selection = "0". (Refer to page 180)

\* When the Pr. 21 Acceleration/deceleration time increments setting is "0" (initial value), the setting range is "0 to 3600s" and setting increments is "0.1s". When the setting is "1", the setting range is "0 to 360s" and the setting increments is "0.01s".

#### (1) Jog operation from outside

- When the jog signal is on, a start and stop can be made by the start signal (STF, STR).
- For the terminal used for JOG operation selection, set "5" in any of Pr.178 to Pr.184 (input terminal function selection) to assign the function.

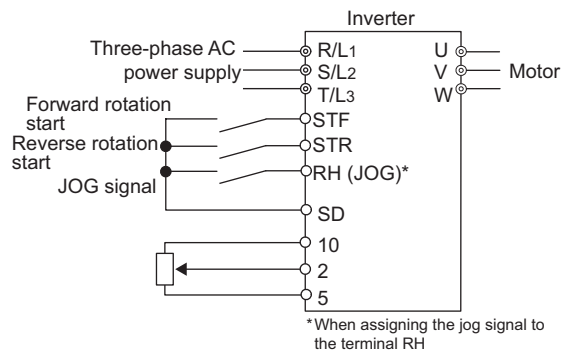
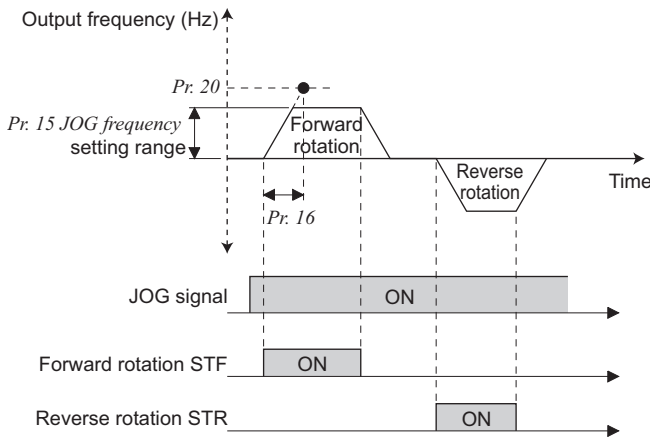

Connection diagram for external jog operation

#### Operation

- Screen at powering on
  - Confirm that the external operation mode is selected. ([EXT] lit)
  - If not displayed, press to change to the external (EXT) operation mode. If the operation mode still does not change, set Pr. 79 to change to the external operation mode.

- Turn on the JOG switch.

- Turn the start switch (STF or STR) on.
  - The motor runs while the start switch (STF or STR) is on.
  - The motor runs at 5Hz. (initial value of Pr. 15)

- Turn the start switch (STF or STR) off.

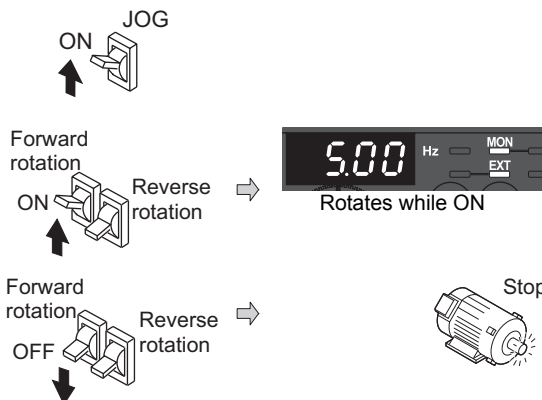

#### REMARKS

- When you want to change the running frequency, change Pr. 15 Jog frequency. (initial value "5Hz")
- When you want to change the acceleration/deceleration time, change Pr. 16 Jog acceleration/deceleration time. (initial value "0.5s")  
The acceleration time and deceleration time cannot be set separately for jog operation.

## 7 Frequency setting by external terminals

### (2) Jog operation from PU

- Selects JOG operation mode from the operation panel and PU (FR-PU04/FR-PU07). Operation is performed only while the start button is pressed.

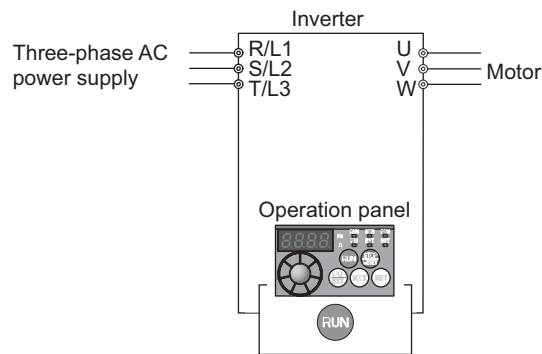

#### Operation

- Confirmation of the RUN indication and operation mode indication
  - The monitor mode should have been selected.
  - The inverter should be at a stop.
- Press **PU/EXT** to choose the PU JOG operation mode.
- Press **RUN**.
  - While **RUN** is pressed, the motor rotates.
  - The motor runs at 5Hz. (*Pr. 15* initial value)

- Release **RUN**

#### [When changing the frequency of PU JOG operation]

- Press **MODE** to choose the parameter setting mode.

- Turn **▲** until *Pr. 15 JOG frequency* appears.

- Press **SET** to show the currently set value. (5Hz)

- Turn **▲** to set the value to "10.00". (10Hz)

- Press **SET** to set.

- Perform the operations in steps 1 to 4.  
The motor rotates at 10Hz.

#### Display



PRM indication is lit.



⇒ (The parameter number read previously appears.)



**Flicker...Parameter setting complete!!**



**NOTE**

- When Pr. 29 Acceleration/deceleration pattern selection = "1" (S-pattern acceleration/deceleration A), the acceleration/deceleration time is the period of time required to reach Pr. 3 Base frequency.
- The Pr. 15 setting should be equal to or higher than the Pr. 13 Starting frequency.
- The JOG signal can be assigned to the input terminal using any of Pr. 178 to Pr. 184 (input terminal function selection). When terminal assignment is changed, the other functions may be affected. Please make setting after confirming the function of each terminal.
- During jog operation, the second acceleration/deceleration via the RT signal cannot be selected. (The other second functions are valid. (Refer to page 227))
- When Pr. 79 Operation mode selection = "4", pressing **RUN** of the operation panel and **FWD** / **REV** of the parameter unit (FR-PU04/FR-PU07) starts the inverter and pressing **STOP/RESET** stops the inverter.
- This function is invalid when Pr. 79 = "3" or "6".



**Parameters referred to**

- Pr. 13 Starting frequency Refer to page 105
- Pr. 29 Acceleration/deceleration pattern selection Refer to page 106
- Pr. 20 Acceleration/deceleration reference frequency, Pr. 21 Acceleration/deceleration time increments Refer to page 102
- Pr. 79 Operation mode selection Refer to page 183
- Pr. 178 to Pr. 184 (input terminal function selection) Refer to page 131

**4.7.3 Remote setting function (Pr. 59)**

- Even if the operation panel is located away from the enclosure, you can use contact signals to perform continuous variable-speed operation, without using analog signals.

Parameter Number	Name	Initial Value	Setting Range	Description	
				RH, RM, RL signal function	Frequency setting storage function
59	Remote function selection	0	0	Multi-speed setting	—
			1	Remote setting	With
			2	Remote setting	Not used
			3	Remote setting	Not used (Turning STF/STR off clears remotely-set frequency.)

The above parameters can be set when Pr. 160 User group read selection = "0". (Refer to page 156)

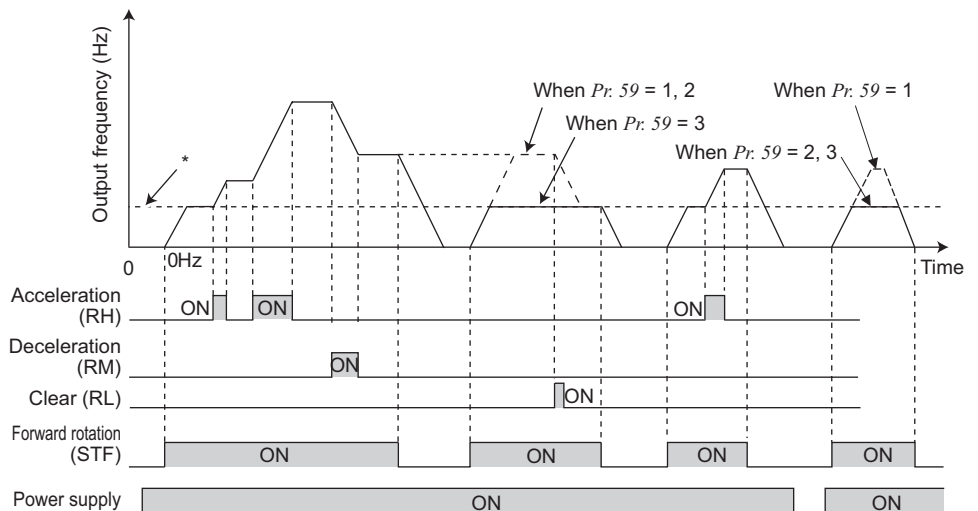
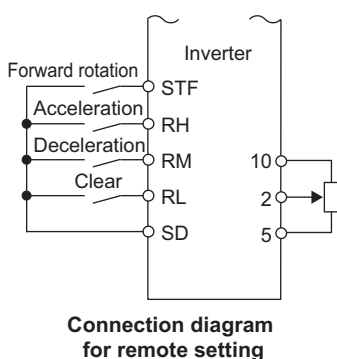

\* External running frequency (other than multi-speed) or PU running frequency

## (1) Remote setting function

• Use Pr. 59 to select whether the remote setting function is used or not and whether the frequency setting storage function in the remote setting mode is used or not.

When Pr. 59 is set to any of "1 to 3" (remote setting function valid), the functions of the RH, RM and RL signals are changed to acceleration (RH), deceleration (RM) and clear (RL).

• When using the remote setting function, following frequencies can be compensated to the frequency set by RH and RM operation according to the operation mode.

During external operation (including Pr. 79 = "4") .....external frequency command other than multi-speed settings

During external operation and PU combined operation (Pr. 79 = "3") .....PU frequency command or terminal 4 input

During PU operation .....PU frequency command

## (2) Frequency setting storage

• The frequency setting storage function stores the remotely-set frequency (frequency set by RH/RM operation) into the memory (EEPROM). When power is switched off once, then on, operation is resumed with that output frequency value.

(Pr. 59 = 1)

<Frequency setting storage conditions>

- Frequency at the point when the start signal (STF or STR) turns off
- The remotely-set frequency is stored every one minute after one minute has elapsed since turn off (on) of both the RH (acceleration) and RM (deceleration) signals. (The frequency is written if the present frequency setting compared with the past frequency setting every one minute is different. The state of the RL signal does not affect writing.)



### NOTE

- The range of frequency changeable by RH (acceleration) and RM (deceleration) is 0 to maximum frequency (Pr. 1 or Pr. 18 setting). Note that the maximum value of set frequency is (main speed + maximum frequency).

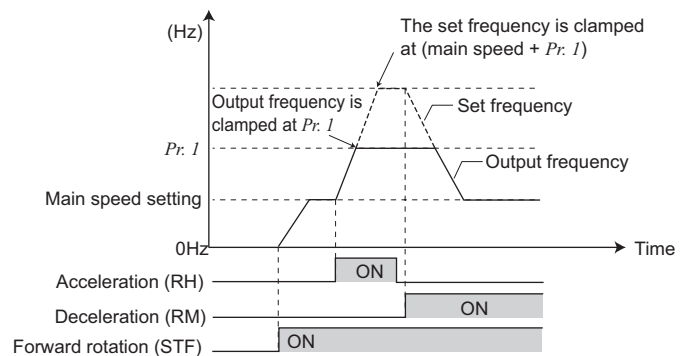

- When the acceleration or deceleration signal switches on, acceleration/deceleration time is as set in Pr. 44 Second acceleration/deceleration time and Pr. 45 Second deceleration time. Note that when long time has been set in Pr. 7 or Pr. 8, the acceleration/deceleration time is as set in Pr. 7 or Pr. 8. (when RT signal is off)  
When the RT signal is on, acceleration/deceleration is made in the time set in Pr. 44 and Pr. 45, regardless of the Pr. 7 or Pr. 8 setting.
- Even if the start signal (STF or STR) is off, turning on the acceleration (RH) or deceleration (RM) signal varies the preset frequency.
- When switching the start signal from ON to OFF, or changing frequency by the RH or RM signal frequently, set the frequency setting value storage function (write to EEPROM) invalid (Pr. 59 = "2, 3"). If set valid (Pr. 59 = "1"), frequency is written to EEPROM frequently, this will shorten the life of the EEPROM.
- The RH, RM, RL signals can be assigned to the input terminal using any Pr. 178 to Pr. 184 (input terminal function selection). When terminal assignment is changed, the other functions may be affected. Please make setting after confirming the function of each terminal.
- Also available for the network operation mode.

**REMARKS**

During jog operation or PID control operation, the remote setting function is invalid.

Setting frequency is "0"

- Even when the remotely-set frequency is cleared by turning on the RL (clear) signal after turn off (on) of both the RH and RM signals, the inverter operates at the remotely-set frequency stored in the last operation if power is reapplied before one minute has elapsed since turn off (on) of both the RH and RM signals
- When the remotely-set frequency is cleared by turning on the RL (clear) signal after turn off (on) of both the RH and RM signals, the inverter operates at the frequency in the remotely-set frequency cleared state if power is reapplied after one minute has elapsed since turn off (on) of both the RH and RM signals.

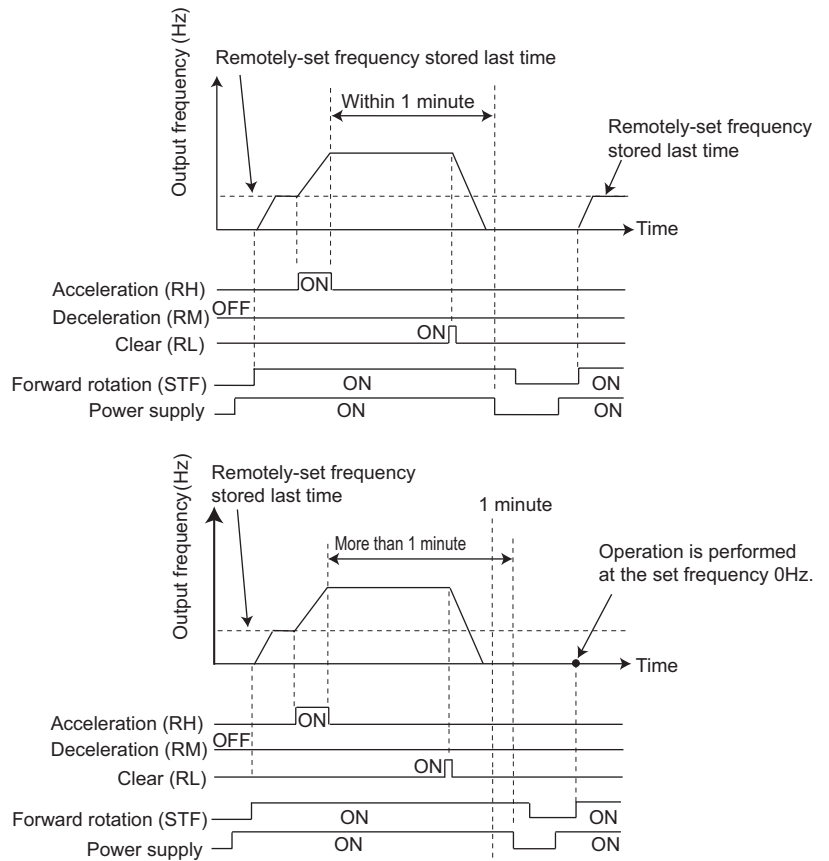

**CAUTION**

When selecting this function, re-set the maximum frequency according to the machine.



**Parameters referred to**

Pr. 1 Maximum frequency, Pr. 18 High speed maximum frequency Refer to page 89  
 Pr. 7 Acceleration time, Pr. 8 Deceleration time, Pr. 44 Second acceleration/deceleration time, Pr. 45 Second deceleration time Refer to page 102  
 Pr. 178 to Pr. 184 (input terminal function selection) Refer to page 131

## 4.8 Setting of acceleration/deceleration time and acceleration/ deceleration pattern

Purpose	Parameter that should be Set		Refer to Page
Motor acceleration/deceleration time setting	Acceleration/deceleration times	Pr. 7, Pr. 8, Pr. 20, Pr. 21, Pr. 44, Pr. 45, Pr. 147	102
Starting frequency	Starting frequency and start-time hold	Pr. 13, Pr. 571	105
Set acceleration/deceleration pattern suitable for application	Acceleration/deceleration pattern	Pr. 29	106
Automatically set optimum acceleration/deceleration time.	Automatic acceleration/ deceleration	Pr. 61 to Pr. 63, Pr. 292	107

### 4.8.1 Setting of the acceleration and deceleration time (Pr. 7, Pr. 8, Pr. 20, Pr. 21, Pr. 44, Pr. 45, Pr. 147)

Used to set motor acceleration/deceleration time.

Set a larger value for a slower speed increase/decrease or a smaller value for a faster speed increase/decrease.

For the acceleration time at automatic restart after instantaneous power failure, refer to *Pr. 611 Acceleration time at a restart (page 154)*.

Parameter Number	Name	Initial Value		Setting Range	Description	
7	Acceleration time	FR-E720-175 or less FR-E740-095 or less	5s	0 to 3600/ 360s *2	Motor acceleration time.	
		FR-E720-240 and 330 FR-E740-120 and 170	10s			
		FR-E720-470 and 600	15s			
8	Deceleration time	FR-E720-175 or less FR-E740-095 or less	5s	0 to 3600/ 360s *2	Motor deceleration time.	
		FR-E720-240 and 330 FR-E740-120 and 170	10s			
		FR-E720-470 and 600	15s			
20 *1	Acceleration/ deceleration reference frequency	60Hz		1 to 400Hz	Frequency that will be the basis of acceleration/deceleration time. <i>Pr. 20</i>	
21 *1	Acceleration/ deceleration time increments	0		0	Increments: 0.1s Range: 0 to 3600s	
				1	Increments: 0.01s Range: 0 to 360s	
44 *1	Second acceleration/ deceleration time	FR-E720-175 or less FR-E740-095 or less	5s	0 to 3600/ 360s *2	Acceleration/deceleration time when the RT signal is on.	
		FR-E720-240 and 330 FR-E740-120 and 170	10s			
		FR-E720-470 and 600	15s			
45 *1	Second deceleration time	9999		0 to 3600/ 360s *2	Deceleration time when the RT signal is on.	
				9999	Acceleration time = deceleration time	
147*1	Acceleration/ deceleration time switching frequency	9999		0 to 400Hz	Frequency when automatically switching to the acceleration/deceleration time of <i>Pr. 44</i> and <i>Pr. 45</i> .	
				9999	No function	

\*1 The above parameters can be set when *Pr. 160 User group read selection* = "0". (Refer to page 180)

\*2 Depends on the *Pr. 21 Acceleration/deceleration time increments* setting. The initial value for the setting range is "0 to 3600s" and the setting increments is "0.1s".



**(1) Acceleration time setting (Pr. 7, Pr. 20)**

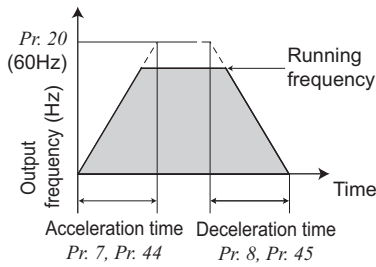

- Use Pr. 7 Acceleration time to set the acceleration time required to reach Pr. 20 Acceleration/deceleration reference frequency from 0Hz.
- Set the acceleration time according to the following formula.

$$\text{Acceleration time setting} = \frac{\text{Pr. 20}}{\text{Maximum operating frequency} - \text{Pr. 13}} \times \text{Acceleration time from stop to maximum operating frequency}$$

Example)When Pr. 20 = 60Hz (initial value), Pr. 13 = 0.5Hz, and acceleration can be made up to the maximum operating frequency of 50Hz in 10s

$$\text{Pr. 7} = \frac{60\text{Hz}}{50\text{Hz} - 0.5\text{Hz}} \times 10\text{s} \doteq 12.1\text{s}$$

**(2) Deceleration time setting (Pr. 8, Pr. 20)**

- Use Pr. 8 Deceleration time to set the deceleration time required to reach 0Hz from Pr. 20 Acceleration/deceleration reference frequency.
- Set the deceleration time according to the following expression.

$$\text{Deceleration time setting} = \frac{\text{Pr. 20}}{\text{Maximum operating frequency} - \text{Pr. 10}} \times \text{Deceleration time from maximum operating frequency to stop}$$

Example)When the frequency can be decelerated down to the maximum operating frequency of 50Hz in 10s with 120Hz set in Pr. 20 and 3Hz set in Pr. 10

$$\text{Pr. 8} = \frac{120\text{Hz}}{50\text{Hz} - 3\text{Hz}} \times 10\text{s} \doteq 25.5\text{s}$$

**(3) Change the setting range and increments of the acceleration/deceleration time (Pr. 21)**

- Use Pr. 21 to set the acceleration/deceleration time and minimum setting range.  
 Value "0" (initial value) .....0 to 3600s (minimum setting increments: 0.1s)  
 Value "1" .....0 to 360s (minimum setting increments: 0.01s)



**NOTE**

- Changing the Pr. 21 setting changes the acceleration/deceleration time setting (Pr. 7, Pr. 8, Pr. 16, Pr. 44, Pr. 45). (It does not influence the setting of Pr. 611 Acceleration time at a restart.)  
 <Example>  
 When Pr. 7 is set to "5.0s" at Pr. 21 setting of "0", and then Pr. 21 is changed to "1", the Pr. 7 setting automatically changes to "0.5s".

## (4) Set two kinds of acceleration/deceleration times (RT signal, Pr. 44, Pr. 45, Pr. 147)

- Pr. 44 and Pr. 45 are valid when the RT signal is on, or the output frequency reaches or exceeds the setting of Pr. 147.
- When "9999" is set to Pr. 45, the deceleration time becomes equal to the acceleration time (Pr. 44).
- For the RT signal, set "3" in any of Pr. 178 to Pr. 184 (input terminal function selection) to assign the function.
- When RT signal is off, automatic switching of the acceleration/deceleration time is available with Pr. 147.

Pr. 147 Setting	Acceleration/Deceleration Time	Description
9999 (initial value)	Pr. 7, Pr. 8	No automatic switching of the acceleration/deceleration time
0.00Hz	Pr. 44, Pr. 45	Second acceleration/deceleration time from a start
0.00Hz ≤ Pr. 147 ≤ Set frequency	Output frequency < Pr. 147: Pr. 7, Pr. 8 Pr. 147 ≤ Output frequency: Pr. 44, Pr. 45	Acceleration/deceleration time automatic switching *
Set frequency < Pr. 147	Pr. 7, Pr. 8	No automatic switching, since output frequency will not reach the switching frequency

\* When the RT signal turns on, the acceleration/deceleration time switches to the second acceleration/deceleration time even when the output frequency is not reached to Pr. 147 setting.

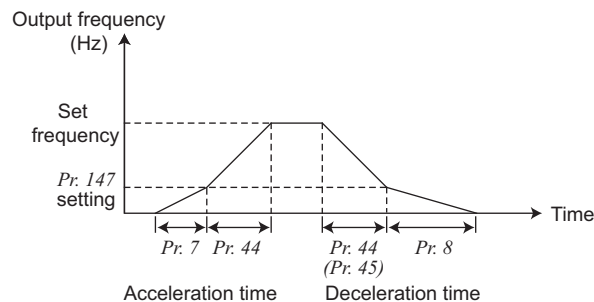

### NOTE

- When the acceleration/deceleration pattern is S-pattern acceleration/deceleration A (refer to page 106), the acceleration/ deceleration time is the time required to reach Pr. 3 Base frequency .
- Acceleration/deceleration time formula when the set frequency is the base frequency or higher

$$t = \frac{4}{9} \times \frac{T}{(Pr. 3)^2} \times f^2 + \frac{5}{9} T$$

**T: Acceleration/deceleration time setting (s)**  
**f: Set frequency (Hz)**

- Guideline for acceleration/deceleration time at the Pr. 3 Base frequency of 60Hz (0Hz to set frequency)

Frequency setting (Hz)	60	120	200	400
Acceleration/ deceleration time (s)				
5	5	12	27	102
15	15	35	82	305

- Changing terminal assignment may affect the other functions. Make setting after confirming the function of each terminal.



### REMARKS

- The RT signal acts as the second function selection signal and makes the other second functions valid. (Refer to page 134)
- If the Pr. 20 setting is changed, the Pr. 125 and Pr. 126 (frequency setting signal gain frequency) settings do not change. Set Pr. 125 and Pr. 126 to adjust the gains.
- When the Pr. 7, Pr. 8, Pr. 44 and Pr. 45 settings are 0.03s or less, the acceleration/deceleration time is 0.04s. At that time, set Pr. 20 to "120Hz" or less.
- Any value can be set to the acceleration/deceleration time but the actual motor acceleration/deceleration time cannot be made shorter than the shortest acceleration/deceleration time determined by the mechanical system J (moment of inertia) and motor torque.



### Parameters referred to

- Pr. 3 Base frequency Refer to page 91
- Pr. 10 DC injection brake operation frequency Refer to page 121
- Pr. 29 Acceleration/deceleration pattern selection Refer to page 106
- Pr. 125, Pr. 126 (frequency setting gain frequency) Refer to page 171
- Pr. 178 to Pr. 184 (input terminal function selection) Refer to page 131

### 4.8.2 Starting frequency and start-time hold function (Pr. 13, Pr. 571)

You can set the starting frequency and hold the set starting frequency for a certain period of time. Set these functions when you need the starting torque or want to smooth motor drive at a start.

Parameter Number	Name	Initial Value	Setting Range	Description
13	Starting frequency	0.5Hz	0 to 60Hz	Frequency at start can be set in the range 0 to 60Hz. Starting frequency at which the start signal is turned on.
571	Holding time at a start	9999	0.0 to 10.0s	Holding time of Pr. 13 Starting frequency.
			9999	Holding function at a start is invalid

The above parameters can be set when Pr. 160 User group read selection = "0". (Refer to page 180)

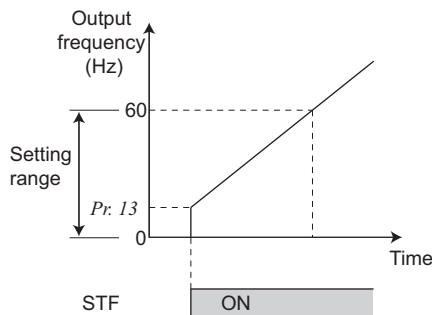

#### (1) Starting frequency setting (Pr. 13)

- Frequency at start can be set in the range 0 to 60Hz.
- You can set the starting frequency at which the start signal is turned on.



#### NOTE

The inverter will not start if the frequency setting signal is less than the value set in Pr. 13. For example, when 5Hz is set in Pr. 13, the motor will not start running until the frequency setting signal reaches 5Hz.

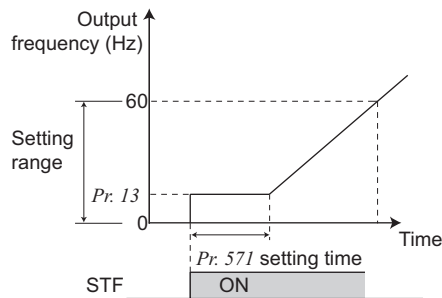

#### (2) Start-time hold function (Pr. 571)

- This function holds during the period set in Pr. 571 and the output frequency set in Pr. 13 Starting frequency.
- This function performs initial excitation to smooth the motor drive at a start.



#### REMARKS

When Pr. 13 = "0Hz", the starting frequency is held at 0.01Hz.



#### NOTE

- When the start signal was turned off during start-time hold, deceleration is started at that point.
- At switching between forward rotation and reverse rotation, the starting frequency is valid but the start-time hold function is invalid.



## CAUTION

Note that when Pr. 13 is set to any value equal to or lower than Pr. 2 Minimum frequency, simply turning on the start signal will run the motor at the preset frequency even if the command frequency is not input.



#### Parameters referred to

Pr. 2 Minimum frequency Refer to page 89

## 4.8.3 Acceleration/deceleration pattern (Pr. 29)

You can set the acceleration/deceleration pattern suitable for application.

Parameter Number	Name	Initial Value	Setting Range	Description
29	Acceleration/deceleration pattern selection	0	0	Linear acceleration/ deceleration
			1	S-pattern acceleration/deceleration A
			2	S-pattern acceleration/deceleration B

The above parameters can be set when Pr. 160 User group read selection = "0". (Refer to page 180)

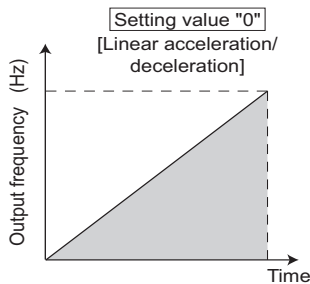

### (1) Linear acceleration/deceleration (Pr. 29 setting "0", initial value)

- For the inverter operation, the output frequency is made to change linearly (linear acceleration/deceleration) to prevent the motor and inverter from excessive stress to reach the set frequency during acceleration, deceleration, etc. when frequency changes. Linear acceleration/deceleration has a uniform frequency/time slope.

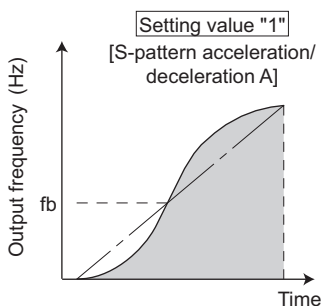

### (2) S-pattern acceleration/deceleration A (Pr. 29 = "1")

- For machine tool spindle applications, etc. Used when acceleration/deceleration must be made in a short time to a high-speed range of not lower than the base frequency. In this acceleration/deceleration pattern, Pr. 3 Base frequency (fb) is the inflection point of the S pattern and you can set the acceleration/deceleration time appropriate for motor torque reduction in a constant-power operation range of base frequency (fb) or higher.

#### NOTE

- As the acceleration/deceleration time of S-pattern acceleration/deceleration A, set the time taken until Pr. 3 Base frequency is reached, not Pr. 20 Acceleration/deceleration reference frequency.

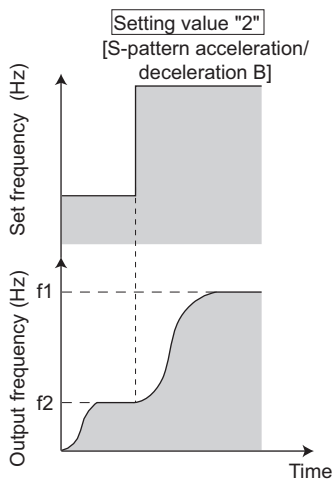

### (3) S-pattern acceleration/deceleration B (Pr. 29 = "2")

- For prevention of load shifting in conveyor and other applications. Since acceleration/deceleration is always made in an S shape from current frequency (f2) to target frequency (f1), this function eases shock produced at acceleration/deceleration and is effective for load collapse prevention, etc.



#### Parameters referred to

Pr. 3 Base frequency Refer to page 91

Pr. 7 Acceleration time, Pr. 8 Deceleration time, Pr. 20 Acceleration/deceleration reference frequency Refer to page 102

**4.8.4 Shortest acceleration/deceleration (automatic acceleration/deceleration)**  
 (Pr. 61 to Pr. 63, Pr. 292, Pr. 293)

The inverter operates in the same conditions as when appropriate values are set in each parameter even if acceleration/deceleration time and V/F pattern are not set. This function is useful when you just want to operate, etc. without fine parameter setting.

Parameter Number	Name	Initial Value	Setting Range	Description
61	Reference current	9999	0 to 500A	Set the reference current during shortest acceleration/deceleration.
			9999	Rated inverter output current value is reference
62	Reference value at acceleration	9999	0 to 200%	Set the limit value during shortest acceleration.
			9999	150% is a limit value
63	Reference value at deceleration	9999	0 to 200%	Set the limit value during shortest deceleration.
			9999	150% is a limit value
292	Automatic acceleration/ deceleration	0	0	Normal mode
			1	Shortest acceleration/deceleration (without brake)
			11	Shortest acceleration/deceleration (with brake)
			7, 8	Brake sequence mode 1, 2 (Refer to page 127)
293	Acceleration/deceleration individual operation selection	0	0	Both acceleration and deceleration are made in the shortest acceleration/deceleration mode
			1	Only acceleration is made in the shortest acceleration/deceleration mode
			2	Only deceleration is made in the shortest acceleration/deceleration mode

**(1) Shortest acceleration/deceleration mode (Pr. 292 = "1, 11", Pr. 293)**

- Set when you want to accelerate/decelerate the motor for the shortest time. It is desired to make acceleration/deceleration in a shorter time for a machine tool etc. but the design values of machine constants are unknown.
- Acceleration/deceleration speed is automatically adjusted at a start of acceleration/deceleration from the value of the setting value of Pr. 7 Acceleration time and Pr. 8 Deceleration time so that acceleration/deceleration is made with the maximum torque the inverter can output. (The setting values of Pr. 7 and Pr. 8 are not changed.)
- Either acceleration or deceleration can be made in the shortest time using Pr. 293 Acceleration/deceleration separate selection mode. When the setting value is "0" (initial value), both acceleration and deceleration can be made in the shortest time.
- Set "11" when an optional MRS, MYS type brake resistor, high-duty brake resistor or brake unit is connected. Deceleration time can be further shortened.
- When the shortest/acceleration mode is selected, the stall prevention operation level during acceleration/deceleration from the value of becomes 150% (adjustable using Pr. 61 to Pr. 63 ). Setting of Pr. 22 Stall prevention operation level is used only during a constant speed operation.
- It is inappropriate to use for the following applications.
  - a) Machine with a large inertia such as a fan (more than 10 times). Since stall prevention operation will be activated for a long time, this type of machine may be brought to an alarm stop due to motor overloading, etc.
  - b) It is desired to always perform operation with a constant acceleration/deceleration time.
  - c) It is desired to perform operation making sure the inverter and motor have enough capability.

 **REMARKS**

- Even if automatic acceleration/deceleration mode has been selected, inputting the jog signal (jog operation) or RT signal (second function selection) during an inverter stop will switch to the normal operation and give priority to jog operation or second function selection. Note that JOG and RT signal input is invalid even if JOG signal and RT signal are input during operation in automatic acceleration/deceleration mode.
- Since acceleration/deceleration is made with the stall prevention operation being activated, the acceleration/deceleration speed always varies according to the load conditions.
- Note that when proper values are set in Pr. 7 and Pr. 8, acceleration/deceleration time may be shorter than selecting shortest acceleration/deceleration mode.

## Setting of acceleration/deceleration time and acceleration/ deceleration pattern

### (2) Adjustment of shortest acceleration/deceleration mode (Pr. 61 to Pr. 63)

•By setting the adjustment parameters Pr. 61 and Pr. 63, the application range can be made wider.

Parameter Number	Name	Setting Range	Description
61	Reference current	0 to 500A	For example, when the motor and inverter are different in capacity, set the rated motor current value. Set reference current (A) of the stall prevention operation level during acceleration/deceleration.
		9999 (initial value)	The rated inverter current is defined as reference.
62	Reference value at acceleration	0 to 200%	Set when it is desired to change the reference level of acceleration and deceleration. Set the stall prevention operation level (ratio to the current value of Pr. 61) during acceleration/deceleration.
63	Reference value at deceleration	9999 (initial value)	The 150% value during shortest acceleration/deceleration is judged as the stall prevention operation level.



#### REMARKS

- Since the Pr. 61 to Pr. 63 settings automatically return to the initial value (9999) if the Pr. 292 setting is changed, set Pr. 292 first when you need to set Pr. 61 to Pr. 63.



#### Parameters referred to

Pr. 0 Torque boost  Refer to page 77

Pr. 7 Acceleration time, Pr. 8 Deceleration time  Refer to page 102

Pr. 22 Stall prevention operation level  Refer to page 85

## 4.9 Selection and protection of a motor

Purpose	Parameter that should be Set		Refer to Page
Motor protection from overheat	Electronic thermal O/L relay	Pr. 9, Pr. 51	109
Use the constant torque motor	Applied motor	Pr. 71	111
The motor performance can be maximized for operation in magnetic flux vector control method.	Offline auto tuning	Pr. 71, Pr. 80 to Pr. 84, Pr. 90 to Pr. 94, Pr. 96, Pr. 859	113

### 4.9.1 Motor overheat protection (Electronic thermal O/L relay) (Pr. 9, Pr. 51)

Set the current of the electronic thermal relay function to protect the motor from overheat. This feature provides the optimum protective characteristics, including reduced motor cooling capability, at low speed.

Parameter Number	Name	Initial Value	Setting Range	Description
9	Electronic thermal O/L relay	Inverter rated current *1	0 to 500A	Set the rated motor current.
51*2	Second electronic thermal O/L relay *3	9999	0 to 500A	Valid when the RT signal is on. Set the rated motor current.
			9999	Second electronic thermal O/L relay invalid

\*1 The initial value of the FR-E720-050 or less, FR-E740-026 or less is set to 85% of the rated inverter current.

\*2 The above parameters can be set when Pr. 160 User group read selection = "0". (Refer to page 180)

\*3 When parameter is read using the FR-PU04, a parameter name different from an actual parameter is displayed.

#### (1) Electronic thermal O/L relay (Pr. 9)

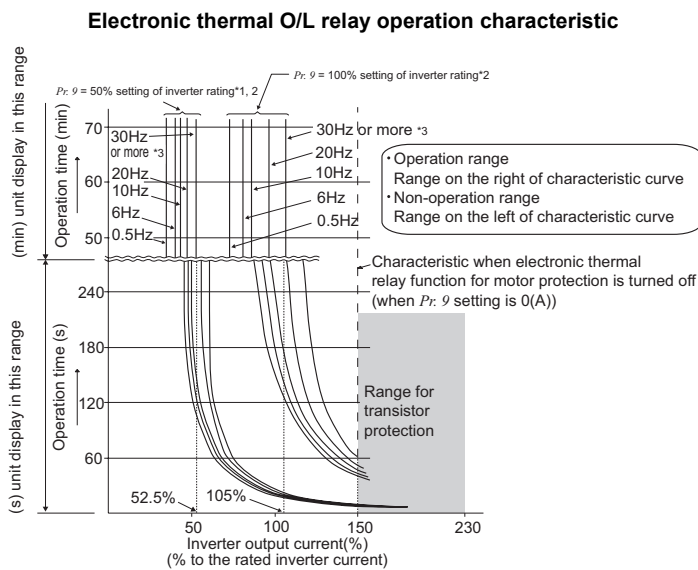

This function detects the overload (overheat) of the motor and trips. (The operation characteristic is shown on the left)

- Set the rated current (A) of the motor in Pr. 9. (If the motor has both 50Hz and 60Hz rating and the Pr. 3 Base frequency is set to 60Hz, set the 1.1 times of the 60Hz rated motor current.)
- Set "0" in Pr. 9 when you do not want to operate the electronic thermal O/L relay, e.g. when using an external thermal relay with the motor. (Note that the output transistor protection of the inverter functions (E.THT).)
- When using a Mitsubishi constant-torque motor
  - 1) Set "1" or "13 to 16", "50", "53", "54" in any of Pr. 71. (This provides a 100% continuous torque characteristic in the low-speed range.
  - 2) Set the rated current of the motor in Pr. 9.

\*1 When a value 50% of the inverter rated output current (current value) is set to Pr. 9

\*2 The % value denotes the percentage to the inverter rated output current. It is not the percentage to the motor rated current.

\*3 When you set the electronic thermal O/L relay dedicated to the Mitsubishi constant-torque motor, this characteristic curve applies to operation at 6Hz or higher.



#### NOTE

- Fault by electronic thermal relay function is reset by inverter power reset and reset signal input. Avoid unnecessary reset and power-off.
- When multiple motors are operated by a single inverter, protection cannot be provided by the electronic thermal function. Install an external thermal relay to each motor.
- When the difference between the inverter and motor capacities is large and the setting is small, the protective characteristics of the electronic thermal relay function will be deteriorated. In this case, use an external thermal relay.
- A special motor cannot be protected by the electronic thermal relay function.
- The operation time of the transistor protection thermal shortens when the Pr. 72 PWM frequency selection setting increases.

## (2) Set two different electronic thermal O/L relays (Pr. 51)

Use this function when running two motors of different rated currents individually by a single inverter. (When running two motors together, use external thermal relays.)

- Set the rated current of the second motor to Pr. 51.
- When the RT signal is on, thermal protection is provided based on the Pr. 51 setting.
- For the terminal used for RT signal input, set "3" in any of Pr. 178 to Pr. 184 (input terminal function selection) to assign the function.

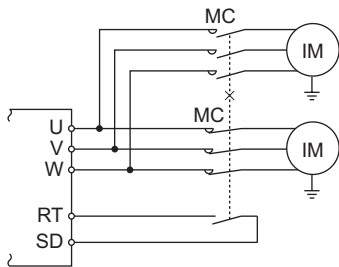

Pr. 450 Second applied motor	Pr. 9 Electronic thermal O/L relay	Pr.51 Second electronic thermal O/L relay	RT = OFF		RT = ON	
			First motor	Second motor	First motor	Second motor
9999	0	9999	×	×	×	×
		0	×	×	×	×
		0.01 to 500	×	Δ	×	○
9999	Other than 0	9999	○	×	○	×
		0	○	×	Δ	×
		0.01 to 500	○	Δ	Δ	○
Other than 9999	0	9999	×	×	×	×
		0	×	×	×	×
		0.01 to 500	×	Δ	×	○
Other than 9999	Other than 0	9999	○	Δ	Δ	○
		0	○	×	Δ	×
		0.01 to 500	○	Δ	Δ	○

○... Output current value is used to perform integration processing.

Δ... Output current is assumed as 0A to perform integration processing. (cooling processing)

×... Electronic thermal relay function is not activated.

### REMARKS

- The RT signal acts as the second function selection signal and makes the other second functions valid. (Refer to page 134)

## (3) Electronic thermal relay function prealarm (TH) and alarm signal (THP signal)

100%: Electronic thermal O/L relay alarm operation value

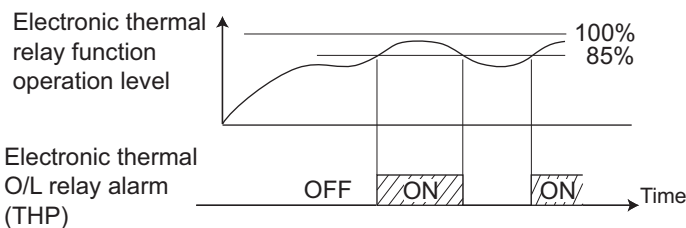

- The alarm signal (THP) is output and electronic thermal relay function prealarm (TH) is displayed when the electronic thermal O/L relay cumulative value reaches 85% of the level set in Pr. 9 or Pr. 51. If it reaches 100% of the Pr. 9 Electronic thermal O/L relay setting, a motor overload trip (E.THM/E.THT) occurs.
- The inverter does not trip even when the alarm signal (THP) is output.
- For the terminal used for the THP signal output, assign the function by setting "8 (positive logic) or 108 (negative logic)" in any of Pr. 190 to Pr. 192 (output terminal function selection) .

### NOTE

- Changing the terminal assignment using Pr.190 to Pr.192 (output terminal function selection) may affect the other functions. Make setting after confirming the function of each terminal.

## (4) External thermal relay input (OH signal)

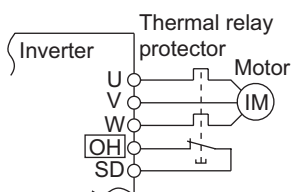

External thermal relay input connection example

- To protect the motor against overheat, use the OH signal when using an external thermal relay or the built-in thermal protector of the motor.
- When the thermal relay operates, the inverter trips and outputs the fault signal (E.OHT).
- For the terminal used for OH signal input, assign the function by setting "7" to any of Pr. 178 to Pr.184 (input terminal function selection) .

### NOTE

- Changing the terminal assignment using Pr. 178 to Pr. 184 (input terminal function selection) may affect the other functions. Make setting after confirming the function of each terminal.



### Parameters referred to

Pr. 71 Applied motor Refer to page 111

Pr. 72 PWM frequency selection Refer to page 166

Pr. 178 to Pr. 184 (input terminal function selection) Refer to page 131

Pr. 190 to Pr. 192 (output terminal function selection) Refer to page 137



### 4.9.2 Applied motor (Pr. 71, Pr. 450)

Setting of the used motor selects the thermal characteristic appropriate for the motor.

Setting is required to use a constant-torque motor. Thermal characteristic of the electronic thermal relay function suitable for the motor is set.

When general-purpose magnetic flux vector or advanced magnetic flux vector control is selected, the motor constants (SF-JR, SF-HR, SF-JRCA, SF-HRCA, etc.) necessary for control are selected as well.

Parameter Number	Name	Initial Value	Setting Range	Description
71	Applied motor	0	0, 1, 3 to 6, 13 to 16, 23, 24, 40, 43, 44, 50, 53, 54	Selecting the standard motor or constant-torque motor sets the corresponding motor thermal characteristic.
450	Second applied motor	9999	0, 1	Set when using the second motor.
			9999	Second motor is invalid (thermal characteristic of the first motor (Pr. 71))

The above parameters can be set when Pr. 160 User group read selection = "0". (Refer to page 180)

#### (1) Set the motor to be used

Refer to the following list and set this parameter according to the motor used.

Pr. 71 (Pr. 450) Setting		Thermal Characteristic of the Electronic Thermal Relay Function	Motor (○: Used motor)		
Pr. 71	Pr. 450		Standard (SF-JR, etc.)	Constant torque (SF-JRCA, etc.)	
0 (Pr. 71 initial value)	—	Thermal characteristics of a standard motor	○		
1	—	Thermal characteristics of the Mitsubishi constant-torque motor		○	
40	—	Thermal characteristic of Mitsubishi high efficiency motor SF-HR	○ *1		
50	—	Thermal characteristic of Mitsubishi constant torque motor SF-HRCA		○ *2	
3	—	Standard motor	Select "Offline auto tuning setting"	○	
13	—	Constant-torque motor		○	
23	—	Mitsubishi standard motor (SF-JR 4P 1.5kW or less)		○	
43	—	Mitsubishi high efficiency motor (SF-HR)		○ *1	
53	—	Mitsubishi constant-torque motor (SF-HRCA)			○ *2
4	—	Standard motor	Auto tuning data can be read, changed, and set.	○	
14	—	Constant-torque motor			○
24	—	Mitsubishi standard motor (SF-JR 4P 1.5kW or less)		○	
44	—	Mitsubishi high efficiency motor (SF-HR)		○*1	
54	—	Mitsubishi constant-torque motor (SF-HRCA)			○ *2
5	—	Standard motor	Star connection	Direct input of motor constants is enabled	○
15	—	Constant-torque motor			○
6	—	Standard motor	Delta connection	Direct input of motor constants is enabled	○
16	—	Constant-torque motor			○
—	9999 (initial value)	Without second applied motor			

\*1 Motor constants of Mitsubishi high efficiency motor SF-HR.

\*2 Motor constants of Mitsubishi constant-torque motor SF-HRCA.

#### REMARKS

- When performing offline auto tuning, set any of "3, 13, 23, 43, 53" in Pr. 71. (Refer to page 113 for offline auto tuning.)
- For the FR-E720-240 and 330, FR-E740-120 and 170, the Pr. 0 Torque boost and Pr. 12 DC injection brake operation voltage settings are automatically changed according to the Pr. 71 setting as follows.

Automatic Change Parameter	Standard Motor Setting *1	Constant-torque Motor Setting *2
Pr. 0	3%	2%
Pr. 12	4%	2%

\*1 Pr. 71 setting: 0, 3 to 6, 23, 24, 40, 43, 44

\*2 Pr. 71 setting: 1, 13 to 16, 50, 53, 54

### (2) Use two motors (Pr. 450)

- Set Pr. 450 *Second applied motor* to use two different motors with one inverter.
- When "9999" (initial value) is set, no function is selected.
- When a value other than 9999 is set in Pr. 450, the second motor is valid when the RT signal turns on.
- For the RT signal, set "3" in any of Pr. 178 to Pr. 184 (*input terminal function selection*) to assign the function.



#### REMARKS

- The RT signal acts as the second function selection signal and makes the other second functions valid. (Refer to page 134)



#### NOTE

- Changing the terminal assignment using Pr. 178 to Pr. 184 (*input terminal function selection*) may affect other functions. Make setting after confirming the function of each terminal.



## CAUTION



Set this parameter correctly according to the motor used.

Incorrect setting may cause the motor to overheat and burn.

Set the electronic thermal relay function to the thermal characteristic for the constant-torque motor when using a geared motor (GM-G, GM-D, GM-SY, GM-HY2 series) to perform advanced magnetic flux vector control or general-purpose magnetic-flux vector control.





#### Parameters referred to

Pr. 0 Torque boost  Refer to page 77

Pr. 12 DC injection brake operation voltage  Refer to page 121

Pr. 80 Motor capacity, Pr. 81 Number of motor poles  Refer to page 113

Pr. 82 to Pr. 84, Pr. 90 to Pr. 94 (motor constants), Pr. 96 Auto tuning setting/status  Refer to page 113

Pr. 800 Control method selection  Refer to page 76

### 4.9.3 To exhibit the best performance of the motor performance (offline auto tuning) (Pr. 71, Pr. 80 to Pr. 84, Pr. 90 to Pr. 94, Pr. 96, Pr. 859)

The motor performance can be maximized with offline auto tuning.

●What is offline auto tuning?

When performing advanced magnetic flux vector control or general-purpose magnetic flux vector control, the motor can be run with the optimum operating characteristics by automatically measuring the motor constants (offline auto tuning) even when each motor constants differs, other manufacturer's motor is used, or the wiring length is long.

Parameter Number	Name	Initial Value		Setting Range	Description
71	Applied motor	0		0, 1, 3 to 6, 13 to 16, 23, 24, 40, 43, 44, 50, 53, 54	By selecting a standard motor or constant-torque motor, thermal characteristic and motor constants of each motor are set.
80	Motor capacity	9999		0.1 to 15kW	Applied motor capacity.
		9999		9999	V/F control
81	Number of motor poles	9999		2, 4, 6, 8, 10	Number of motor poles.
		9999		9999	V/F control
82	Motor excitation current	9999		0 to 500A	Tuning data (The value measured by offline auto tuning is automatically set.)
		9999		9999	Uses the Mitsubishi motor (SF-JR, SF-HR, SF-JRCA, SF-HRCA) constants.
83	Motor rated voltage	200V class	200V	0 to 1000V	Rated motor voltage (V).
		400V class	400V		
84	Rated motor frequency	60Hz		10 to 120Hz	Rated motor frequency (Hz).
90	Motor constant (R1)	9999		0 to 50Ω, 9999	Tuning data (The value measured by offline auto tuning is automatically set.) 9999: Uses the Mitsubishi motor (SF-JR, SF-HR, SF-JRCA, SF-HRCA) constants.
91	Motor constant (R2)	9999		0 to 50Ω, 9999	
92	Motor constant (L1)	9999		0 to 1000mH, 9999	
93	Motor constant (L2)	9999		0 to 1000mH, 9999	
94	Motor constant (X)	9999		0 to 100%, 9999	
96	Auto tuning setting/ status	0		0	Offline auto tuning is not performed
		0		1	For advanced magnetic flux vector control Offline auto tuning is performed without motor running (all motor constants).
		0		11	For general-purpose magnetic flux vector control Offline auto tuning is performed without motor running. (motor constant (R1) only)
		0		21	Offline auto tuning for V/F control (automatic restart after instantaneous power failure (with frequency search)) (Refer to page 157)
859	Torque current	9999		0 to 500A	Tuning data (The value measured by offline auto tuning is automatically set.)
		9999		9999	Uses the Mitsubishi motor (SF-JR, SF-HR, SF-JRCA, SF-HRCA) constants.

- The setting range and increments of *Pr. 82*, *Pr. 90* to *Pr. 94* and *Pr. 859* changes according to the setting value of *Pr. 71* and *Pr. 96*.

Applied Motor		Internal Stored Value *1		Direct Input Value *2		Auto Tuning Measured Value *3	
Parameter Number	Function Name	Setting Range	Setting Increments	Setting Range	Setting Increments	Setting Range	Setting Increments
82	Motor excitation current	0 to 500A, 9999	0.01A	0 to 500A, 9999	0.01A	0 to ****, 9999	1
90	Motor constant (R1)	0 to 50Ω, 9999	0.001Ω	0 to 50Ω, 9999	0.001Ω	0 to ****, 9999	1
91	Motor constant (R2)	0 to 50Ω, 9999	0.001Ω	0 to 50Ω, 9999	0.001Ω	0 to ****, 9999	1
92	Motor constant (L1)	0 to 1000mH, 9999	0.1mH	0 to 50Ω, 9999	0.001Ω	0 to ****, 9999	1
93	Motor constant (L2)	0 to 1000mH, 9999	0.1mH	0 to 50Ω, 9999	0.001Ω	0 to ****, 9999	1
94	Motor constant (X)	0 to 100%, 9999	0.1%	0 to 500Ω, 9999	0.01Ω	0 to ****, 9999	1
859	Torque current	0 to 500A, 9999	0.01A	0 to 500A, 9999	0.01A	0 to ****, 9999	1

\*1 When *Pr. 71* = "0, 1, 40 or 50", or setting value of *Pr. 96* after performing offline auto tuning is read "3, 13, 23".

\*2 When *Pr. 71* = "5, 6, 15, or 16"

\*3 When *Pr. 71* = "3, 13, 23, 43 or 53" and setting value of *Pr. 96* after performing offline auto tuning is read "3, 13, 23". Or when *Pr. 71* = "4, 14, 24, 44 or 54".



### POINT

- This function is made valid only when a value other than "9999" is set in *Pr. 80* and *Pr. 81* and advanced magnetic flux vector control or general-purpose magnetic flux vector control is selected.
- You can copy the offline auto tuning data (motor constants) to another inverter with the PU (FR-PU07).
- Even when motors (other manufacturer's motor, SF-JRC, etc.) other than Mitsubishi standard motor, high efficiency motor (SF-JR, SF-HR 0.2kW or more), and Mitsubishi constant-torque motor (SF-JRCA SF-HRCA four-pole 0.4kW to 15kW) are used or the wiring length is long, using the offline auto tuning function runs the motor with the optimum operating characteristics.
- Tuning is enabled even when a load is connected to the motor.  
As the motor may run slightly, fix the motor securely with a mechanical brake or make sure that there will be no problem in safety if the motor runs (caution is required especially in elevator). Note that tuning performance is unaffected even if the motor runs slightly.
- Reading/writing/copy of motor constants tuned by offline auto tuning are enabled.
- The offline auto tuning status can be monitored with the operation panel and PU (FR-PU04/FR-PU07).
- Do not connect a surge voltage suppression filter (FR-ASF-H/FR-BMF-H) between the inverter and motor.

### (1) Before performing offline auto tuning

Check the following before performing offline auto tuning.

- Make sure advanced magnetic flux vector control or general-purpose magnetic flux vector control (*Pr. 80*, *Pr. 81*) is selected. (Tuning can be performed even under V/F control selected by turning on X18.)
- A motor should be connected. Note that the motor should be at a stop at a tuning start.
- The motor capacity should be equal to or one rank lower than the inverter capacity. (note that the capacity should be 0.1kW or more)
- The maximum frequency is 120Hz.
- A high-slip motor, high-speed motor and special motor cannot be tuned.
- As the motor may run slightly, fix the motor securely with a mechanical brake or make sure that there will be no problem in safety if the motor runs (caution is required especially in elevator). Note that tuning performance is unaffected even if the motor runs slightly.
- Offline auto tuning will not be performed properly if it is performed with a surge voltage suppression filter (FR-ASFH/FR-BMF-H) connected between the inverter and motor. Remove it before starting tuning.

**(2) Setting**

- 1) Select advanced magnetic flux vector control (Refer to page 79) or general-purpose magnetic flux vector control (Refer to page 82).
- 2) Set "1" or "11" in Pr. 96 Auto tuning setting/status.
  - When the setting is "1" ..... Tune all motor constants without running the motor.  
 When performing advanced magnetic flux vector control, set "1" to perform tuning.  
 It takes approximately 25 to 75s\* until tuning is completed.  
 (Excitation noise is produced during tuning.)  
 \*Tuning time differs according to the inverter capacity and motor type.
  - When the setting is "11" ..... Tune motor constants (R1) only without running the motor.  
 When performing general-purpose magnetic flux vector control, set "11" to perform tuning.  
 It takes approximately 9s until tuning is completed.
- 3) Set the rated motor current (initial value is rated inverter current) in Pr. 9 Electronic thermal O/L relay. (Refer to page 109)
- 4) Set the rated voltage of motor (initial value is 200V/400V) in Pr. 83 Rated motor voltage and rated motor frequency (initial value is 60Hz) in Pr. 84 Rated motor frequency.  
 (For a Japanese standard motor, etc. which has both 50Hz and 60Hz rated values, use it with an initial value (200V/60Hz or 400V/60Hz).
- 5) Set Pr. 71 Applied motor according to the motor used.

Motor		Pr. 71 Setting *1
Mitsubishi standard motor Mitsubishi high efficiency motor	SF-JR	3
	SF-JR 4P 1.5kW or less	23
	SF-HR	43
	Others	3
Mitsubishi constant-torque motor	SF-JRCA 4P	13
	SF-HRCA 4P	53
	Others (SF-JRC, etc.)	13
Other manufacturer's standard motor	—	3
Other manufacturer's constant-torque motor	—	13

\*1 Refer to page 111, for other settings of Pr. 71.

## (3) Execution of tuning



### POINT

Before performing tuning, check the monitor display of the operation panel or parameter unit (FR-PU04/FR-PU07) if the inverter is in the status for tuning. (Refer to 2) below) When the start command is turned on under V/F control, the motor starts.

- When performing tuning or PU operation, press **RUN** of the operation panel or **FWD** or **REV** of the parameter unit (FR-PU04/FR-PU07).  
For external operation, turn on the run command (STF signal or STR signal). Tuning starts.



### NOTE

- To force tuning to end, use the MRS or RES signal or press **STOP/RESET** of the operation panel. (Turning the start signal (STF signal or STR signal) off also ends tuning.)
- During offline auto tuning, only the following I/O signals are valid: (initial value)
  - Input terminal <valid signal> MRS, RES, STF, STR
  - Output terminal RUN, AM, A, B, C
 Note that the progress status of offline auto tuning is output in eight steps from AM when speed and output frequency are selected.
- Since the RUN signal turns on when tuning is started, caution is required especially when a sequence which releases a mechanical brake by the RUN signal has been designed.
- When executing offline auto tuning, input the run command after switching on the main circuit power (R/L1, S/L2, T/L3) of the inverter.
- Do not perform ON/OFF switching of the second function selection signal (RT) during execution of offline auto tuning. Auto tuning is not executed properly.

- Monitor is displayed on the operation panel and parameter unit (FR-PU04/FR-PU07) during tuning as below.

	Parameter Unit (FR-PU04/FR-PU07) Display		Operation Panel Indication	
Pr. 96 setting	1	11	1	11
(1) Setting				
(2) Tuning in progress				
(3) Normal end				
(4) Error end (when inverter protective function operation is activated)				



### REMARKS

- Reference: Offline auto tuning time (when the initial value is set)

Offline Auto Tuning Setting	Time
Tune all motor constants (Pr. 96 = "1")	Approximately 25 to 75s (Tuning time differs according to the inverter capacity and motor type.)
Tune motor constants (R1) only (Pr. 96 = "11")	Approximately 9s

- The set frequency monitor displayed during the offline auto tuning is 0Hz.

- 3) When offline auto tuning ends, press  of the operation panel during PU operation. For external operation, turn off the start signal (STF signal or STR signal) once.  
This operation resets the offline auto tuning and the PU's monitor display returns to the normal indication.  
(Without this operation, next operation cannot be started.)

 **REMARKS**

- Do not change the *Pr. 96* setting after completion of tuning (3 or 13).  
If the *Pr. 96* setting is changed, tuning data is made invalid.  
If the *Pr. 96* setting is changed, tuning must be performed again.
- 4) If offline auto tuning ended in error (see the table below), motor constants are not set.  
Perform an inverter reset and restart tuning.

Error Display	Error Cause	Remedy
8	Forced end	Set "1" or "11" in <i>Pr. 96</i> and perform tuning again.
9	Inverter protective function operation	Make setting again.
91	Current limit (stall prevention) function was activated.	Set "1" in <i>Pr. 156</i> .
92	Converter output voltage reached 75% of rated value.	Check for fluctuation of power supply voltage.
93	Calculation error A motor is not connected.	Check the motor wiring and make setting again.

- 5) When tuning is ended forcibly by pressing  or turning off the start signal (STF or STR) during tuning, offline auto tuning does not end normally. (The motor constants have not been set.)  
Perform an inverter reset and restart tuning.

 **NOTE**

- The motor constants measured once in the offline auto tuning are stored as parameters and their data are held until the offline auto tuning is performed again.
- An instantaneous power failure occurring during tuning will result in a tuning error.  
After power is restored, the inverter goes into the normal operation mode. Therefore, when STF (STR) signal is on, the motor runs in the forward (reverse) rotation.
- Any alarm occurring during tuning is handled as in the ordinary mode. Note that if a fault retry has been set, retry is ignored.

 **CAUTION**

 As the motor may run slightly during offline auto tuning, fix the motor securely with a mechanical brake or make sure that there will be no problem in safety if the motor runs. Note that if the motor runs slightly, tuning performance is unaffected.

### (4) Utilizing or changing offline auto tuning data for use

The data measured in the offline auto tuning can be read and utilized or changed.

<Operating procedure>

- 1) Set *Pr. 71* according to the motor used.

Motor	<i>Pr. 71</i> Setting *1	
Mitsubishi standard motor	SF-JR	4
	SF-JR 4P 1.5kW or less	24
	SF-HR	44
Mitsubishi high efficiency motor	SF-HR	44
	Others	4
Mitsubishi constant-torque motor	SF-JRCA 4P	14
	SF-HRCA 4P	54
	Others (SF-JRC, etc.)	14
Other manufacturer's standard motor	-	4
Other manufacturer's constant-torque motor	-	14

\*1 For other settings of *Pr.71*, refer to page 111.

- 2) In the parameter setting mode, read the following parameters and set desired values.

Parameter Number	Name	Setting Range	Setting Increments	Initial Value
82	Motor excitation current	0 to ****, 9999	1	9999
90	Motor constant (R1)	0 to ****, 9999	1	9999
91	Motor constant (R2)	0 to ****, 9999	1	9999
92	Motor constant (L1)	0 to ****, 9999	1	9999
93	Motor constant (L2)	0 to ****, 9999	1	9999
94	Motor constant (X)	0 to ****, 9999	1	9999
859	Torque current	0 to ****, 9999	1	9999



#### REMARKS

- When "9999" is set in *Pr. 82*, *Pr. 90* to *Pr. 94*, *Pr. 859*, Mitsubishi motor (SF-JR, SF-HR, SF-JRCA, SF-HRCA) constants are used.
- As the motor constants measured in the offline auto tuning have been converted into internal data (\*\*\*\*), refer to the following setting example when making setting:

Setting example To slightly increase *Pr. 90* value (5%)

When *Pr. 90* is displayed as "2516",

set 2642, i.e.  $2516 \times 1.05 = 2641.8$ , in *Pr. 90*.

(The value displayed has been converted into a value for internal use. Hence, simple addition of a given value to the displayed value has no significance.)



**(5) Method to set the motor constants without using the offline auto tuning data**

The *Pr. 90* and *Pr. 94* motor constants may either be entered in [ $\Omega$ ] or in [mH]. Before starting operation, confirm which motor constant unit is used.

- To enter the *Pr. 90* to *Pr. 94* motor constants in [ $\Omega$ ]

<Operating procedure>

1) Set *Pr. 71* according to the motor used.

		Star Connection Motor	Delta Connection Motor
Setting	Standard motor	5	6
	Constant-torque motor	15	16

2) In the parameter setting mode, read the following parameters and set desired values.

$I_q$  = torque current,  $I_{100}$  = rated current,  $I_0$  = no load current

$$I_q = \sqrt{I_{100}^2 - I_0^2}$$

Parameter Number	Name	Setting Range	Setting Increments	Initial Value
82	Motor excitation current (no load current)	0 to 500A, 9999	0.01A	9999
90	Motor constant (r1)	0 to 50 $\Omega$ , 9999	0.001 $\Omega$	9999
91	Motor constant (r2)	0 to 50 $\Omega$ , 9999	0.001 $\Omega$	9999
92	Motor constant (x1)	0 to 50 $\Omega$ , 9999	0.001 $\Omega$	9999
93	Motor constant (x2)	0 to 50 $\Omega$ , 9999	0.001 $\Omega$	9999
94	Motor constant (xm)	0 to 500 $\Omega$ , 9999	0.01 $\Omega$	9999
859	Torque current	0 to 500A, 9999	0.01A	9999

3) Refer to the following table and set *Pr. 83* and *Pr. 84*.

Parameter Number	Name	Setting Range	Setting Increments	Initial Value	
83	Motor rated voltage	0 to 1000V	0.1V	200V class	200V
				400V class	400V
84	Rated motor frequency	10 to 120Hz	0.01Hz	60Hz	



**REMARKS**

- When "9999" is set in *Pr. 82*, *Pr. 90* to *Pr. 94*, *Pr. 859*, Mitsubishi motor (SF-JR, SF-HR, SF-JRCA, SF-HRCA) constants are used.



**NOTE**

- If "star connection" is mistaken for "delta connection" or vice versa during setting of *Pr. 71*, advanced magnetic flux vector control and general-purpose magnetic flux vector control cannot be exercised properly.

## 7 Selection and protection of a motor

● To enter the Pr. 90 and Pr. 94 motor constants in [mH]

<Operating procedure>

1) Set Pr. 71 according to the motor used.

Motor		Pr. 71 Setting *1
Mitsubishi standard motor	SF-JR	0
Mitsubishi high efficiency motor	SF-HR	40
Mitsubishi constant-torque motor	SF-JRCA 4P	1
	SF-HRCA 4P	50

\*1 For other settings of Pr. 71, refer to page 111.

2) In the parameter setting mode, read the following parameters and set desired values.

Calculate the Pr. 94 value from the following formula.

$$\text{Pr. 94 setting} = \left(1 - \frac{M^2}{L1 \times L2}\right) \times 100 (\%)$$

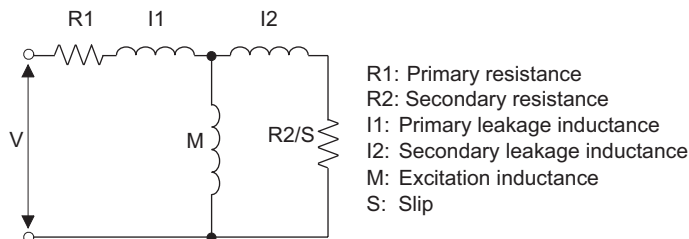

$$L1 = I1 + M: \text{Primary inductance}$$

$$L2 = I2 + M: \text{Secondary inductance}$$

Motor equivalent circuit diagram

Parameter Number	Name	Setting Range	Setting Increments	Initial Value
82	Motor excitation current (no load current)	0 to 500A, 9999	0.01A	9999
90	Motor constant (R1)	0 to 50Ω, 9999	0.001Ω	9999
91	Motor constant (R2)	0 to 50Ω, 9999	0.001Ω	9999
92	Motor constant (L1)	0 to 1000mH, 9999	0.1mH	9999
93	Motor constant (L2)	0 to 1000mH, 9999	0.1mH	9999
94	Motor constant (X)	0 to 100%, 9999	0.1%	9999
859	Torque current	0 to 500A, 9999	0.01A	9999

3) Refer to the following table and set Pr. 83 and Pr. 84.

Parameter Number	Name	Setting Range	Setting Increments	Initial Value	
83	Motor rated voltage	0 to 1000V	0.1V	200V class	200V
				400V class	400V
84	Rated Motor Frequency	10 to 120Hz	0.01Hz	60Hz	

### REMARKS

- When "9999" is set in Pr. 82, Pr. 90 to Pr. 94, Pr. 859, Mitsubishi motor (SF-JR, SF-HR, SF-JRCA, SF-HRCA) constants are used.



### Parameters referred to

Pr. 7 Acceleration time, Pr. 8 Deceleration time Refer to page 102

Pr. 9 Electronic thermal O/L relay Refer to page 109

Pr. 71 Applied motor Refer to page 111

Pr. 80 Motor capacity, Pr. 81 Number of motor poles Refer to page 76

Pr. 156 Stall prevention operation selection Refer to page 85

Pr. 178 to Pr. 184 (input terminal function selection) Refer to page 131

Pr. 190 to Pr. 192 (output terminal function selection) Refer to page 137

Pr. 800 Control method selection Refer to page 76

## 4.10 Motor brake and stop operation

Purpose	Parameter that should be Set		Refer to Page
Motor braking torque adjustment	DC Injection brake	Pr. 10 to Pr. 12	121
Improve the motor braking torque with an option	Selection of a regenerative brake	Pr. 30, Pr. 70	122
Coast the motor to a stop	Selection of motor stopping method	Pr. 250	124
Used to stop the motor with a mechanical brake (vibration restraint at stop-on-contact)	Stop-on-contact control	Pr. 6, Pr. 48, Pr. 270, Pr. 275, Pr. 276	125
Used to stop the motor with a mechanical brake (operation timing of a mechanical brake)	Brake sequence function	Pr. 278 to Pr. 283, Pr. 292	127

### 4.10.1 DC injection brake (Pr. 10 to Pr. 12)

The DC injection brake can be operated at a motor stop to adjust the stop timing and braking torque.

In DC injection brake operation, DC voltage is directly applied to the motor to prevent the motor shaft from rotating. The motor will not return to the original position if the motor shaft rotates due to external force.

Parameter Number	Name	Initial Value	Setting Range	Description
10	DC injection brake operation frequency	3Hz	0 to 120Hz	Operation frequency of the DC injection brake.
11	DC injection brake operation time	0.5s	0	DC injection brake disabled
			0.1 to 10s	Operation time of the DC injection brake.
12	DC injection brake operation voltage	FR-E720-008 and 015	6%	DC injection brake voltage (torque). When "0" is set, DC injection brake is disabled.
		FR-E720-030 to 330	4%	
		FR-E740-016 to 170	4%	
		FR-E720-470 and 600	2%	

The above parameters can be set when Pr. 160 User group read selection = "0". (Refer to page 180)

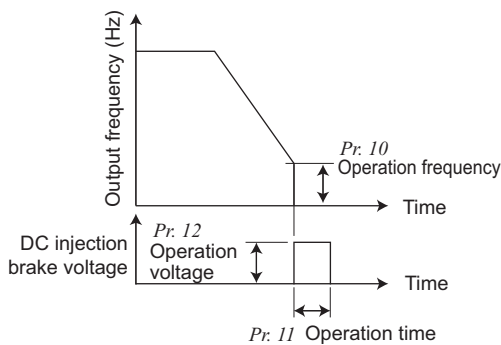

#### (1) Operation frequency setting (Pr. 10)

- After the frequency at which the DC injection brake will be operated is set to Pr. 10, the DC voltage is applied to the motor when this frequency is reached during deceleration.

#### (2) Operation time setting (Pr. 11)

- In Pr. 11, set the time of the DC injection brake.
- When the motor does not stop due to large load moment (J), increasing the setting produces an effect.
- When Pr. 11 = "0s", the DC injection brake is disabled. (At a stop, the motor coasts.)

#### (3) Operation voltage (torque) setting (Pr. 12)

- Use Pr. 12 to set the percentage to the power supply voltage.
- When Pr. 12 = "0%", the DC injection brake is disabled. (At a stop, the motor coasts.)
- When using the constant-torque motor (SF-JRCA) and energy saving motor (SF-HR, SF-HRCA), change the Pr. 12 setting as follows:  
SF-JRCA:  
FR-E720-175 or less, FR-E740-095 or less...4%  
FR-E720-240 or more, FR-E740-120 or more...2%  
SF-HR, SF-HRCA:  
FR-E720-175 or less, FR-E740-095 or less...4%  
FR-E720-240 and 330, FR-E740-120 and 170...3%  
FR-E720-470 or more...2%

## REMARKS

- For the FR-E720-240 and 330, FR-E740-120 and 170, when the *Pr. 12* setting is the following, changing the *Pr. 71 Applied motor* setting automatically changes the *Pr. 12* setting. Therefore, it is not necessary to change the *Pr. 12* setting.
  - (a) When 4% (initial value) is set in *Pr. 12*  
The *Pr. 12* setting is automatically changed to 2% if the *Pr. 71* value is changed from the value selecting the standard motor (0, 3 to 6, 23, 24, 40, 43, 44) to the value selecting the constant torque motor (1, 13 to 16, 50, 53, 54).
  - (b) When 2% is set in *Pr. 12*  
The *Pr. 12* setting is automatically changed to 4% (initial value) if the *Pr. 71* value is changed from the value selecting the constant torque motor (1, 13 to 16, 50, 53, 54) to the value selecting the standard motor (0, 3 to 6, 23, 24, 40, 43, 44).
- Even if the *Pr. 12* setting is increased, braking torque is limited so that the output current is within the rated inverter current.



## CAUTION

As stop holding torque is not produced, install a mechanical brake.



### Parameters referred to

- Pr. 13 Starting frequency* Refer to page 105
- Pr. 71 Applied motor* Refer to page 111

### 4.10.2 Selection of a regenerative brake (*Pr. 30, Pr. 70*)

- When making frequent starts/stops, use the optional brake resistor (MRS type), high-duty brake resistor (FR-ABR) and brake unit (FR-BU2) to increase the regenerative brake duty.
- Use a power regeneration common converter (FR-CV) for continuous operation in regeneration status.  
Use the high power factor converter (FR-HC) to reduce harmonics, improve the power factor, or continuously use the regenerative status.

Parameter Number	Name	Initial Value	Setting Range	Description
30	Regenerative function selection	0	0	Without regenerative function, Brake resistor (MRS type), Brake unit (FR-BU2) Power regeneration common converter (FR-CV) High power factor converter (FR-HC)
			1	High-duty brake resistor (FR-ABR)
			2	High power factor converter (FR-HC) when automatic restart after instantaneous power failure is selected
70	Special regenerative brake duty	0%	0 to 30%	Brake duty when using the high-duty brake resistor (FR-ABR)

The above parameters can be set when *Pr. 160 User group read selection* = "0". (Refer to page 180)

#### (1) When using the brake resistor (MRS type), brake unit (FR-BU2), power regeneration common converter (FR-CV), and high power factor converter (FR-HC).

- Set *Pr. 30* to "0" (initial value). The *Pr. 70* setting is made invalid.  
At this time, the regenerative brake duty is as follows.
  - FR-E720-175 or less, FR-E740-095 or less .....3%
  - FR-E720-240 or more, FR-E740-120 or more .....2%
- Assign the inverter operation enable signal (X10) to the contact input terminal. To make protective coordination with the FR-HC and FR-CV, use the inverter operation enable signal to shut off the inverter output.  
Input the RDY signal of the FR-HC (RDYB signal of the FR-CV).
- For the terminal used for X10 signal input, assign its function by setting "10" (X10) to any of *Pr. 178* to *Pr. 184*.

#### (2) When using the high-duty brake resistor (FR-ABR) (FR-E720-030 or more, FR-E740-016 or more)

- Set "1" in *Pr. 30*.
- Set *Pr. 70* as follows.
  - FR-E720-330 or less, FR-E740-170 or less ..... 10%
  - FR-E720-470 and 600 .....6%

**(3) When a high power factor converter (FR-HC) is used and automatic restart after instantaneous power failure function is made valid.**

- When automatic restart after instantaneous power failure function of both the FR-HC and inverter is made valid (when a value other than "9999" is set in *Pr: 57 Restart coasting time*), set "2" in *Pr: 30* .
- Set *Pr: 70* to "0%" (initial value).
- When the FR-HC detects power failure during inverter operation, the RDY signal turns on, resulting in the motor coasting. Turning the RDY signal off after power restoration, the inverter detects the motor speed (depends on the *Pr:162 Automatic restart after instantaneous power failure selection* ) and restarts automatically after instantaneous power failure.

**(4) Regenerative brake duty alarm output and alarm signal (RBP signal)**

100%: regenerative overvoltage protection operation value

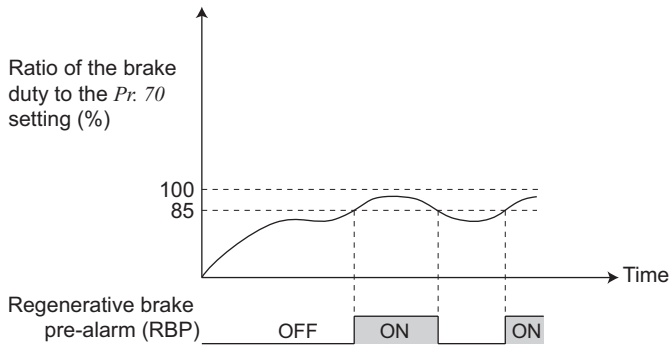

- [RB] appears on the operation panel and an alarm signal (RBP) is output when 85% of the regenerative brake duty set in *Pr: 70* is reached. If the regenerative brake duty reaches 100% of the *Pr: 70* setting, a regenerative overvoltage (E.OV1 to E.OV3) occurs. Note that [RB] is not displayed when *Pr: 30* = "0".
- The inverter does not trip even when the alarm (RBP) signal is output.
- For the terminal used for the RBP signal output, assign the function by setting "7 (positive logic) or 107 (negative logic)" in any of *Pr: 190 to Pr: 192 (output terminal function selection)* .

 **REMARKS**

- The MRS signal can also be used instead of the X10 signal. (Refer to page 133)
- Refer to page 29 to 33 for connecting the brake resistor (MRS type, MYS type), high-duty brake resistor (FR-ABR), brake unit (FR-BU2), high power factor converter (FR-HC), and power regeneration common converter (FR-CV).



 **NOTE**

- **When terminal assignment is changed using *Pr: 178 to Pr: 184 (input terminal function selection)* and *Pr: 190 to Pr: 192 (output terminal function selection)*, the other functions may be affected. Make setting after confirming the function of each terminal. (Refer to page 131)**

 **WARNING**

 **The value set in *Pr: 70* must not exceed the setting of the brake resistor used. Otherwise, the resistor can overheat.**

 **Parameters referred to**

- Pr: 57 Restart coasting time*  Refer to page 154
- Pr: 178 to Pr: 184 (input terminal function selection)*  Refer to page 131
- Pr: 190 to Pr: 192 (output terminal function selection)*  Refer to page 137

## 4.10.3 Stop selection (Pr. 250)

Used to select the stopping method (deceleration to a stop or coasting) when the start signal turns off.  
 Used to stop the motor with a mechanical brake, etc. together with switching off of the start signal.  
 You can also select the operations of the start signals (STF/STR). (Refer to page 135 for start signal selection)

Parameter Number	Name	Initial Value	Setting Range	Description	
				Start signal (STF/STR) (Refer to page 135)	Stop operation
250	Stop selection	9999	0 to 100s	STF signal: Forward rotation start STR signal: Reverse rotation start	The motor is coasted to a stop when the preset time elapses after the start signal is turned off.
			1000s to 1100s	STF signal: Start signal STR signal: Forward/reverse signal	The motor is coasted to a stop (Pr. 250 - 1000)s after the start signal is turned off.
			9999	STF signal: Forward rotation start STR signal: Reverse rotation start	When the start signal is turned off, the motor decelerates to stop.
			8888	STF signal: Start signal STR signal: Forward/reverse signal	

The above parameters can be set when Pr. 160 User group read selection = "0". (Refer to page 180)

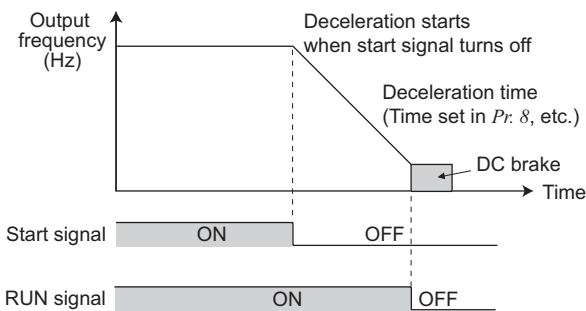

### (1) Decelerate the motor to a stop

- Set Pr. 250 to "9999" (initial value) or "8888".
- The motor decelerates to a stop when the start signal (STF/STR) turns off.

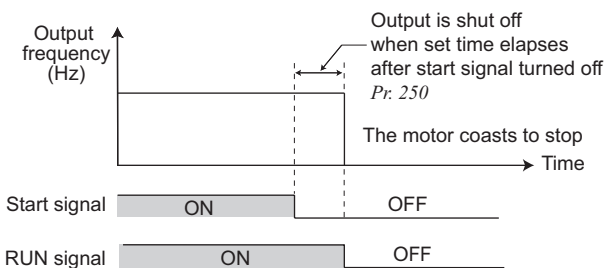

### (2) Coast the motor to a stop

- Use Pr. 250 to set the time from when the start signal turns off until the output is shut off. When any of "1000 to 1100" is set, the output is shut off in (Pr. 250 - 1000)s.
- The output is shut off when the time set in Pr. 250 has elapsed after the start signal had turned off. The motor coasts to a stop.
- The RUN signal turns off when the output stops.

### REMARKS

Stop selection is invalid when the following functions are activated.

- Power failure stop function (Pr. 261)
- PU stop (Pr. 75)
- Deceleration stop because of communication error (Pr. 502)
- Emergency stop by LonWORKS communication

### NOTE

- When the start signal is turned on again during motor coasting, the motor starts at Pr. 13 starting frequency.

### Parameters referred to

Pr. 7 Acceleration time, Pr. 8 Deceleration time Refer to page 102  
 Pr. 13 Starting frequency Refer to page 105

### 4.10.4 Stop-on contact control function (Pr. 6, Pr. 48, Pr. 270, Pr. 275, Pr. 276)

AD MFVC GP MFVC

To ensure accurate positioning at the upper limit etc. of a lift, stop-on-contact control causes a mechanical brake to be closed while the motor is developing a holding torque to keep the load in contact with a mechanical stopper etc. This function suppresses vibration which is liable to occur when the load is stopped upon contact in vertical motion applications, ensuring steady precise positioning.

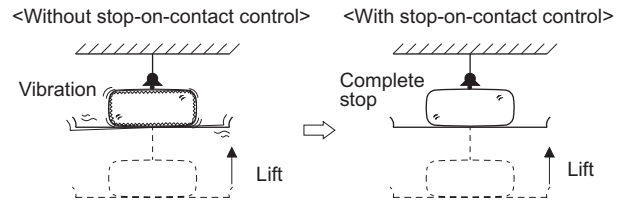

Parameter Number	Name	Initial Value	Setting Range	Description
6	Multi-speed setting (low speed)	10Hz	0 to 400Hz	Sets the output frequency for stop-on-contact control.
48	Second stall prevention operation current	9999	0 to 200%	Sets the stall prevention operation level for stall prevention operation level.
			9999	Pr. 22 setting
270	Stop-on contact control selection	0	0	Normal operation
			1	Stop-on-contact control
275	Stop-on contact excitation current low-speed multiplying factor	9999	0 to 300%	Set the force (holding torque) for stop-on-contact control. Normally set 130% to 180%. Valid only during advanced magnetic flux vector control
			9999	Without compensation
276	PWM carrier frequency at stop-on contact	9999	0 to 9	Sets a PWM carrier frequency for stop-on-contact control.
			9999	As set in Pr. 72 PWM frequency selection.

#### (1) Connection and operation example

Sink logic

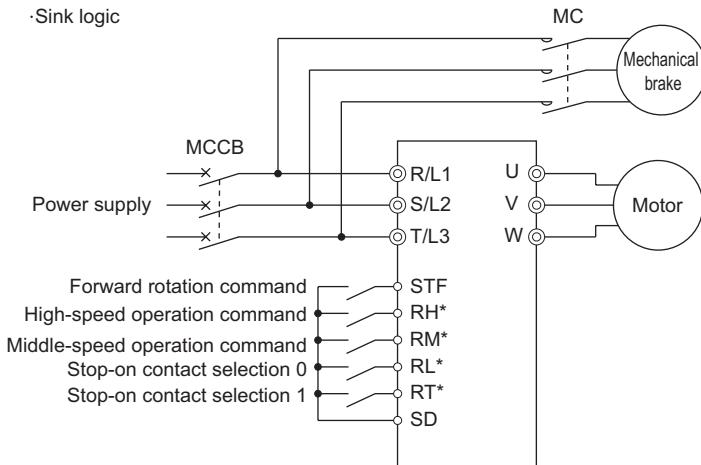

\* The input signal terminal used differs according to the Pr. 180 to Pr. 184 settings.

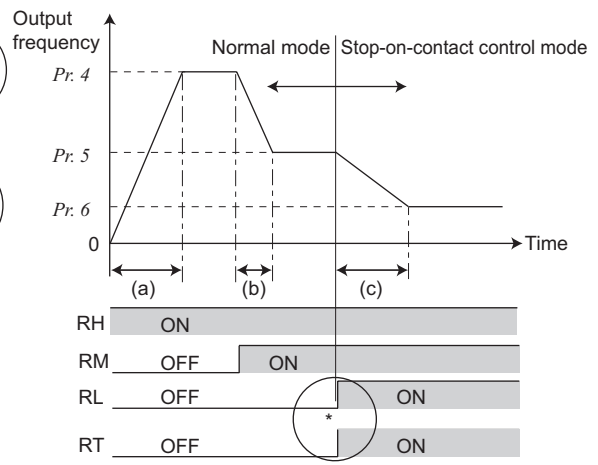

\* Goes into stop-on-contact control when both RL and RT switch on. RL and RT may be switched on in any order with any time difference.

(a) Acceleration time (Pr. 7) (b) Deceleration time (Pr. 8) (c) Second deceleration time (Pr. 44/Pr. 45)

#### (2) Set stop-on-contact control

- Make sure that the inverter is in external operation mode. (Refer to page 183)
- Select advanced magnetic flux vector control or general-purpose magnetic flux vector control.
- Set "1" in Pr. 270 Stop-on contact control selection.
- Set output frequency during stop-on-contact control in Pr. 6 Multi-speed setting (low speed). The frequency should be as low as possible (about 2Hz). If it is set to more than 30Hz, the operating frequency will be 30Hz.
- When both the RT and RL signals are switched on, the inverter enters the stop-on-contact mode, in which operation is performed at the frequency set in Pr. 6 independently of the preceding speed.
- For the terminal used for X18 signal input, set "3" in any of Pr. 178 to Pr. 184 (input terminal function selection) and "0" in Pr. 178 to Pr. 184 (input terminal function selection) to assign the function.



#### NOTE

- By increasing the Pr. 275 setting, the low-speed (stop-on-contact) torque increases, but overcurrent fault (E.OCT) may occur or the machine may oscillate in a stop-on-contact state.
- The stop-on-contact function is different from servo-lock function, and if used to stop or hold a load for an extended period, this function can cause the motor to overheat. After a stop, immediately change to a mechanical brake to hold the load.
- Under the following operating conditions, the stop-on-contact function is made invalid: PU operation (Pr. 79), JOG operation (JOG signal), PU+external operation (Pr. 79), PID control function operation (Pr. 128), remote setting function operation (Pr. 59), automatic acceleration/deceleration operation (Pr. 292)

## (3) Function switching of stop-on-contact control selection

Main Functions	Normal Operation (either RL or RT is off or both are off)	With stop-on-contact Control (both RL and RT are on)
Output frequency	Multi-speed 0 to 5V, 0 to 10V 4 to 20mA etc.	Pr. 6 setting
Stall prevention operation level	Pr. 22 setting	Pr. 48 setting (Pr. 22 when Pr. 48 = "9999")
Excitation current low speed scaling factor	—	Only Pr. 275 (0 to 300%) is compensated before both RL and RT turn on.
Carrier frequency	Pr. 72 setting	Output frequency is 3Hz or less When Pr. 276 setting (Pr. 72 when Pr. 276 = "9999")
Fast-response current limit	Valid	Invalid

## (4) Set frequency when stop-on-contact control (Pr. 270 = 1) is selected

- The following table lists the frequencies set when the input terminals (RH, RM, RL, RT, JOG) are selected together. Bold frame indicates stop-on-contact control is valid.
- Stop-on-contact control is invalid when remote setting function is selected (Pr. 59 = 1 to 3).

Input Signal (○ = on)					Set Frequency
RH	RM	RL	RT	JOG	
○					Pr. 4 Multi-speed setting (high speed)
	○				Pr. 5 Multi-speed setting (middle speed)
		○			Pr. 6 Multi-speed setting (low speed)
			○		By 0 to 5V(0 to 10V), 4 to 20mA input
				○	Pr. 15 JOG frequency
○	○				Pr. 26 Multi-speed setting (speed 6)
○		○			Pr. 25 Multi-speed setting (speed 5)
○			○		Pr. 4 Multi-speed setting (high speed)
○				○	Pr. 15 JOG frequency
	○	○			Pr. 24 Multi-speed setting (speed 4)
	○		○		Pr. 5 Multi-speed setting (middle speed)
	○			○	Pr. 15 JOG frequency
		○	○		<b>Pr. 6 Multi-speed setting (low speed)</b>
		○		○	Pr. 15 JOG frequency
			○	○	Pr. 15 JOG frequency
		○	○	○	Pr. 15 JOG frequency

Input Signal (○ = on)					Set Frequency
RH	RM	RL	RT	JOG	
	○		○	○	Pr. 15 JOG frequency
	○	○		○	Pr. 15 JOG frequency
	○	○	○		<b>Pr. 6 Multi-speed setting (low speed)</b>
○			○	○	Pr. 15 JOG frequency
○		○		○	Pr. 15 JOG frequency
○		○	○		<b>Pr. 6 Multi-speed setting (low speed)</b>
○	○			○	Pr. 15 JOG frequency
○	○		○		Pr. 26 Multi-speed setting (speed 6)
○	○	○			Pr. 27 Multi-speed setting (speed 7)
	○	○	○	○	Pr. 15 JOG frequency
○		○	○	○	Pr. 15 JOG frequency
○	○		○	○	Pr. 15 JOG frequency
○	○	○		○	<b>Pr. 6 Multi-speed setting (low speed)</b>
○	○	○	○	○	Pr. 15 JOG frequency
					By 0 to 5V(0 to 10V), 4 to 20mA input



### NOTE

- Changing the terminal function using any of Pr. 178 to Pr. 184 may affect the other functions. Make setting after confirming the function of each terminal.



### Parameters referred to

- Pr. 4 to Pr. 6, Pr. 24 to Pr. 27 (multi-speed setting) Refer to page 95
- Pr. 15 JOG frequency Refer to page 97
- Pr. 48 Second stall prevention operation current Refer to page 85
- Pr. 59 Remote function selection Refer to page 99
- Pr. 72 PWM frequency selection Refer to page 166
- Pr. 79 Operation mode selection Refer to page 183
- Pr. 128 PID action selection Refer to page 234
- Pr. 178 to Pr. 184 (input terminal function selection) Refer to page 131
- Pr. 292 Automatic acceleration/deceleration Refer to page 107



4.10.5 Brake sequence function (Pr. 278 to Pr. 283, Pr. 292) **AD MFVC** **GP MFVC**

This function is used to output from the inverter the mechanical brake operation timing signal in vertical lift and other applications.

This function prevents the load from dropping with gravity at a start due to the operation timing error of the mechanical brake or an overcurrent alarm from occurring at a stop, ensuring secure operation.

Parameter Number	Name	Initial Value	Setting Range	Description
278	Brake opening frequency	3Hz	0 to 30Hz	Set to the rated slip frequency of the motor + about 1.0Hz. This parameter may be set only if Pr. 278 ≤ Pr. 282.
279	Brake opening current	130%	0 to 200%	Generally, set this parameter to about 50 to 90%. If the setting is too low, the load is liable to drop due to gravity at start. Suppose that the rated inverter current is 100%.
280	Brake opening current detection time	0.3s	0 to 2s	Generally, set this parameter to about 0.1 to 0.3s.
281	Brake operation time at start	0.3s	0 to 5s	When Pr. 292 = "7", set the mechanical delay time until the brake is loosened. Set the mechanical delay time until the brake is loosened + about 0.1 to 0.2s when Pr. 292 = "8".
282	Brake operation frequency	6Hz	0 to 30Hz	Set the frequency to activate the mechanical brake by turning off the brake opening request signal (BOF). Generally, set this parameter to the Pr. 278 setting + 3 to 4Hz. This parameter may be set only if Pr. 278 ≤ Pr. 282.
283	Brake operation time at stop	0.3s	0 to 5s	Set the mechanical delay time until the brake is closed + 0.1s when Pr. 292 = 7. Sets the mechanical delay time until the brake is closed + 0.2 to 0.3s when Pr. 292 = 8.
292	Automatic acceleration/ deceleration	0	0	Normal operation mode
			1, 11	Shortest acceleration/deceleration mode (Refer to page 107)
			7	Brake sequence mode 1
			8	Brake sequence mode 2

<Connection diagram>

- Sink logic
- Pr. 184 = 15
- Pr. 190 = 20

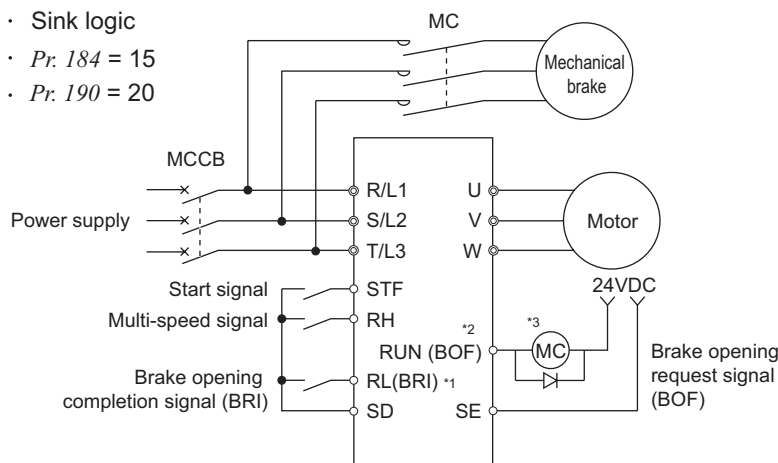

- \*1 The input signal terminal used differs according to the Pr. 178 to Pr. 184 settings.
- \*2 The output signal terminal used differs according to the Pr. 190 to Pr. 192 settings.
- \*3 The current should be within the permissible current of transistor in the inverter. (24V 0.1ADC)



**NOTE**

- When brake sequence mode is selected, automatic restart after instantaneous power failure is invalid.
- When using this function, set the acceleration time to 1s or longer.
- Changing the terminal function using any of Pr. 178 to Pr. 184 and Pr. 190 to Pr. 192 may affect the other functions. Make setting after confirming the function of each terminal.

## (1) Set the brake sequence mode

- Select advanced magnetic flux vector control or general-purpose magnetic flux vector control.  
The brake sequence function is valid only when the external operation mode, external/PU combined operation mode 1 or network operation mode is selected.
- Set "7 or 8" (brake sequence mode) in *Pr. 292* .  
To ensure more complete sequence control, it is recommended to set "7" (brake opening completion signal input) in *Pr. 292*.
- Set "15" in any of *Pr. 178 to Pr. 184 (input terminal function selection)* and assign the brake opening completion signal (BRI) to the input terminal.
- Set "20 (positive logic)" or "120 (negative logic)" in any of *Pr. 190 to Pr. 192 (output terminal function selection)* and assign the brake opening request signal (BOF) to the output terminal.

## (2) With brake opening completion signal input (*Pr. 292 = "7"*)

- When the start signal is input to the inverter, the inverter starts running. When the internal speed command reaches the value set in *Pr. 278* and the output current is not less than the value set in *Pr. 279*, the inverter outputs the brake opening request signal (BOF) after the time set in *Pr. 280* has elapsed.
- When the time set in *Pr. 281* elapses after the brake opening completion signal (BRI) was activated, the inverter increases the output frequency to the set speed.
- When the speed has decreased to the frequency set in *Pr. 282* during deceleration, the BOF signal is turned off. When the time set in *Pr. 283* elapses after the electromagnetic brake operation was completed and the BRI signal was turned off, the inverter output is switched off.

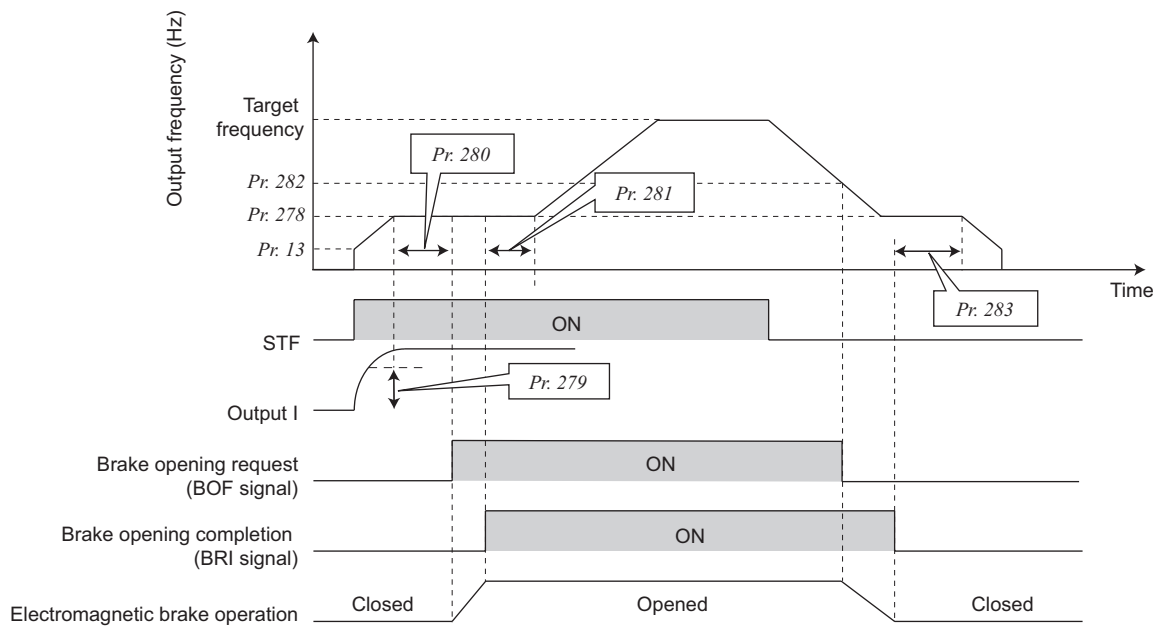

**(3) With brake opening completion signal input (Pr.292 = "8")**

- When the start signal is input to the inverter, the inverter starts running. When the internal speed command reaches the value set in Pr. 278 and the output current is not less than the value set in Pr. 279, the inverter outputs the brake opening request signal (BOF) after the time set in Pr. 280 has elapsed.
- When the time set in Pr. 281 elapses after the BOF signal is output, the inverter increases the output frequency to the set speed.
- When the speed has decreased to the frequency set in Pr. 282 during deceleration, the brake opening request signal (BOF) is turned off. When the time set in Pr. 283 has elapsed after the BOF signal is turned off, the inverter output is switched off.

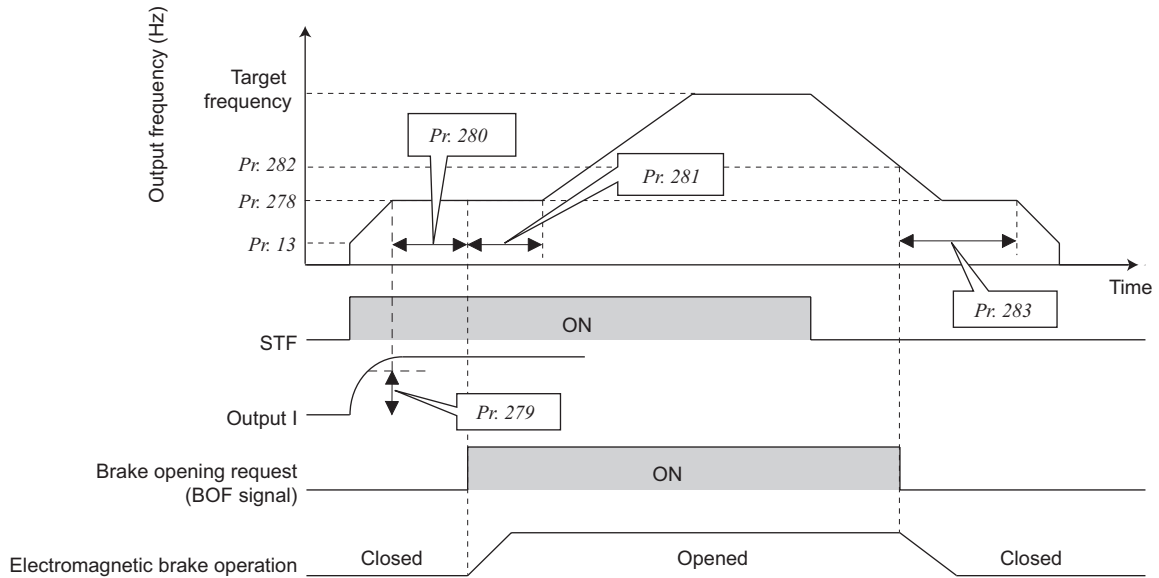

**REMARKS**

- If brake sequence mode has been selected, inputting the jog signal (jog operation) or RT signal (second function selection) during an inverter stop will make brake sequence mode invalid and give priority to jog operation or second function selection. Note that JOG and RT signal input is invalid even if JOG signal and RT signal are input during operation in brake sequence mode.

### (4) Protective functions

If any of the following errors occurs in the brake sequence mode, the inverter results in a fault, trips, and turns off the brake opening request signal (BOF).

Fault Display	Description
E.MB4	Although more than 2s have elapsed after the start command (forward or reverse rotation) is input, the brake opening request signal (BOF) does not turn on.
E.MB5	Although more than 2s have elapsed after the brake opening request signal (BOF) turned on, the brake opening completion signal (BRI) does not turn on.
E.MB6	Though the inverter had turned on the brake opening request signal (BOF), the brake opening completion signal (BRI) turned off midway.
E.MB7	Although more than 2s have elapsed after the brake opening request signal (BOF) turned off at a stop, the brake opening completion signal (BRI) does not turn off.



#### NOTE

- A too large setting of *Pr. 278 Brake opening frequency* activates stall prevention operation and may cause **E.MB4**.
- If the sum of the time between *Pr. 13 Starting frequency* and *Pr. 278 Brake opening frequency* + *Pr. 280 Brake opening current detection time* is more than 2s, **E.MB4** occurs.

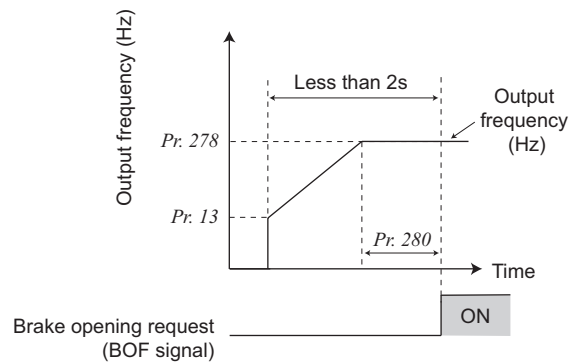

#### Parameters referred to

- Pr. 80 Motor capacity, Pr. 81 Number of motor poles* Refer to page 76
- Pr. 180 to Pr. 184 (input terminal function selection)* Refer to page 131
- Pr. 190 to Pr. 192 (output terminal function selection)* Refer to page 137
- Pr. 800 Control method selection* Refer to page 76

## 4.11 Function assignment of external terminal and control

Purpose	Parameter that should be Set		Refer to Page
Assign function to input terminal	Input terminal function selection	Pr. 178 to Pr. 184	131
Set MRS signal (output shutoff) to NC contact specification	MRS input selection	Pr. 17	133
Assign start signal and forward/reverse command to other signals	Start signal (STF/STR) operation selection	Pr. 250	135
Assign function to output terminal	Output terminal function assignment	Pr. 190 to Pr. 192	137
Detect output frequency	Up-to-frequency sensitivity Output frequency detection	Pr. 41 to Pr. 43	141
Detect output current	Output current detection Zero current detection	Pr. 150 to Pr. 153	142
Remote output function	Remote output	Pr. 495 to Pr. 497	144

### 4.11.1 Input terminal function selection (Pr. 178 to Pr. 184)

Use these parameters to select/change the input terminal functions.

Parameter Number	Name	Initial Value	Initial Signal	Setting Range
178	STF terminal function selection	60	STF (forward rotation command)	0 to 5, 7, 8, 10, 12, 14 to 16, 18, 24, 25, 60, 62, 65 to 67, 9999
179	STR terminal function selection	61	STR (reverse rotation command)	0 to 5, 7, 8, 10, 12, 14 to 16, 18, 24, 25, 61, 62, 65 to 67, 9999
180	RL terminal function selection	0	RL (low-speed operation command)	0 to 5, 7, 8, 10, 12, 14 to 16, 18, 24, 25, 62, 65 to 67, 9999
181	RM terminal function selection	1	RM (middle speed operation command)	
182	RH terminal function selection	2	RH (high-speed operation command)	
183	MRS terminal function selection	24	MRS (output stop)	
184	RES terminal function selection	62	RES (inverter reset)	

The above parameters can be set when Pr. 160 User group read selection = "0". (Refer to page 180)

#### (1) Input terminal function assignment

- Using Pr. 178 to Pr. 184, set the functions of the input terminals.
- Refer to the following table and set the parameters:

Setting	Signal	Function		Related Parameters	Refer to Page
0	RL	Pr. 59 = 0 (initial value)	Low-speed operation command	Pr. 4 to Pr. 6, Pr. 24 to Pr. 27 Pr.232 to Pr.239	95
		Pr. 59 = 1, 2 *1	Remote setting (setting clear)	Pr. 59	99
		Pr. 270 = 1 *2	Stop-on contact selection 0	Pr. 270, Pr. 275, Pr. 276	125
1	RM	Pr. 59 = 0 (initial value)	Middle-speed operation command	Pr. 4 to Pr. 6, Pr. 24 to Pr. 27, Pr. 232 to Pr. 239	95
		Pr. 59 = 1, 2 *1	Remote setting (deceleration)	Pr. 59	99
2	RH	Pr. 59 = 0 (initial value)	High-speed operation command	Pr. 4 to Pr. 6, Pr. 24 to Pr. 27, Pr. 232 to Pr. 239	95
		Pr. 59 = 1, 2 *1	Remote setting (acceleration)	Pr. 59	99

Setting	Signal	Function	Related Parameters	Refer to Page
3	RT	Second function selection	Pr. 44 to Pr. 51	134
		Pr. 270 = 1 *2	Stop-on contact selection 1	Pr. 270, Pr. 275, Pr. 276
4	AU	Terminal 4 input selection	Pr. 267	168
5	JOG	Jog operation selection	Pr. 15, Pr. 16	97
7	OH	External thermal relay input *3	Pr. 9	109
8	REX	15-speed selection (combination with three speeds RL, RM, RH)	Pr. 4 to Pr. 6, Pr. 24 to Pr. 27, Pr. 232 to Pr. 239	95
10	X10	Inverter run enable signal (FR-HC, FR-CV connection)	Pr. 30, Pr. 70	122
12	X12	PU operation external interlock	Pr. 79	183
14	X14	PID control valid terminal	Pr. 127 to Pr. 134	234
15	BRI	Brake opening completion signal	Pr. 278 to Pr. 283	127
16	X16	PU-external operation switchover (turning on X16 selects external operation)	Pr. 79, Pr. 340	190
18	X18	V/F switchover (V/F control is exercised when X18 is on)	Pr. 80, Pr. 81, Pr. 800	76, 79, 82, 113
24	MRS	Output stop	Pr. 17	133
25	STOP	Start self-holding selection	—	124
60	STF	Forward rotation (assigned to STF terminal (Pr. 178) only)	—	135
61	STR	Reverse rotation command (assigned to STR terminal (Pr. 179) only)	—	135
62	RES	Inverter reset	—	—
65	X65	PU/NET operation switchover (turning on X65 selects PU operation)	Pr. 79, Pr. 340	191
66	X66	External/NET operation switchover (turning on X66 selects NET operation)	Pr. 79, Pr. 340	191
67	X67	Command source switchover (turning on X67 makes Pr. 338 and Pr. 339 commands valid)	Pr. 338, Pr. 339	194
9999	—	No function	—	—

\*1 When Pr. 59 Remote function selection = "1" or "2", the functions of the RL, RM and RH signals are changed as given in the table.

\*2 When Pr. 270 Stop-on contact control selection = "1", functions of RL and RT signals are changed as in the table.

\*3 The OH signal turns on when the relay contact "opens".



### NOTE

- Changing the terminal assignment using Pr.178 to Pr.184 (input terminal function selection) may affect the other functions. Make setting after confirming the function of each terminal.
- One function can be assigned to two or more terminals. In this case, the terminal inputs are ORed.
- The priorities of the speed commands are in order of jog, multi-speed setting (RH, RM, RL, REX) and PID (X14).
- When the X10 signal (FR-HC, FR-CV connection-inverter operation enable signal) is not set or when the PU operation external interlock (X12) signal is not assigned with Pr.79 Operation mode selection set to "7", the MRS signal shares this function.
- Use common terminals to assign multi-speeds (7 speeds) and remote setting. They cannot be set individually. (Common terminals are used since these functions are designed for speed setting and need not be set at the same time.)
- When V/F control is selected by V/F switchover (X18 signal), second function is also selected at the same time. Control between V/F and advanced (general-purpose) magnetic flux can not be switched during operation. In case control is switched between V/F and advanced (general-purpose) magnetic flux, only second function is selected.
- Turning the AU signal on makes terminal 2 (voltage input) invalid.

### (2) Response time of each signal

- The response time of the X10 signal and MRS signal is within 2ms.  
The response time of other signals is within 20ms.

### 4.11.2 Inverter output shutoff signal (MRS signal, Pr. 17)

The inverter output can be shut off by the MRS signal. Also, logic for the MRS signal can be selected.

Parameter Number	Name	Initial Value	Setting Range	Description
17	MRS input selection	0	0	Normally open input
			2	Normally closed input (NC contact input specifications)
			4	External terminal: Normally closed input (NC contact input specifications) Communication: Normally open input

The above parameters can be set when Pr. 160 User group read selection = "0". (Refer to page 180)

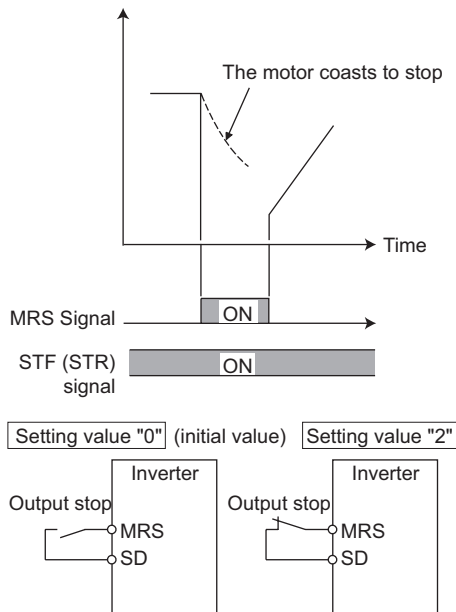

#### (1) Output shutoff signal (MRS signal)

- Turning on the output shutoff signal (MRS) during inverter running shuts off the output immediately.
- MRS signal may be used as described below.
  - When mechanical brake (e.g. electromagnetic brake) is used to stop motor  
The inverter output is shut off when the mechanical brake operates.
  - To provide interlock to disable operation by the inverter  
With the MRS signal on, the inverter cannot be operated if the start signal is entered into the inverter.
  - Coast the motor to a stop.  
When the start signal is turned off, the inverter decelerates the motor to a stop in the preset deceleration time, but when the MRS signal is turned on, the motor coasts to a stop.

#### (2) MRS signal logic inversion (Pr. 17)

- When Pr. 17 is set to "2", the MRS signal (output stop) can be changed to the normally closed (NC contact) input specification. When the MRS signal turns on (opens), the inverter shuts off the output.

#### (3) Assign a different action for each MRS signal input from communication and external terminal (Pr. 17 = "4")

- When Pr. 17 is set to "4", the MRS signal from external terminal (output stop) can be changed to the normally closed (NC contact) input, and the MRS signal from communication can be changed to the normally open (NO contact) input. This function is useful to perform operation by communication with MRS signal from external terminal remained on.

External MRS	Communication MRS	Pr. 17 Setting		
		0	2	4
OFF	OFF	Operation enabled	Output shutoff	Output shutoff
OFF	ON	Output shutoff	Output shutoff	Output shutoff
ON	OFF	Output shutoff	Output shutoff	Operation enabled
ON	ON	Output shutoff	Operation enabled	Output shutoff

#### REMARKS

- The MRS signal is assigned to the terminal MRS in the initial setting. By setting "24" in any of Pr.178 to Pr.184 (input terminal function selection), you can assign the RT signal to the other terminal.
- The MRS signal can shut off the output, independently of the PU, external or network operation mode.

#### NOTE

- Changing the terminal assignment using Pr. 178 to Pr. 184 (input terminal function selection) may affect the other functions. Make setting after confirming the function of each terminal.



#### Parameters referred to

Pr. 178 to Pr. 184 (input terminal function selection) Refer to page 131

### 4.11.3 Condition selection of function validity by second function selection signal (RT)

You can select the second function using the RT signal.

- When the RT signal turns on, the second function becomes valid.
- For the X74 signal, set "3" in any of *Pr. 178 to Pr. 184 (input terminal function selection)* to assign the function.
- The second function has the following applications.
  - (a) Switching between normal use and emergency use
  - (b) Switching between heavy load and light load
  - (c) Changing of acceleration/deceleration time by broken line acceleration/deceleration
  - (d) Switching of characteristic between the main motor and sub motor

#### Second function connection diagram

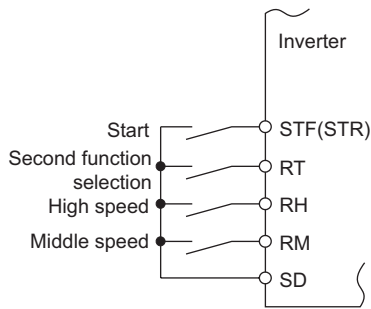

#### Second acceleration/deceleration time

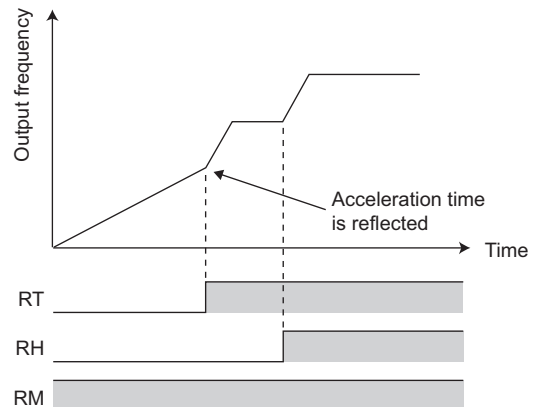

Function	First Function Parameter Number	Second Function Parameter Number	Refer to Page
Torque boost	Pr. 0	Pr. 46	77
Base frequency	Pr. 3	Pr. 47	91
Acceleration time	Pr. 7	Pr. 44	102
Deceleration time	Pr. 8	Pr. 44, Pr. 45	102
Electronic thermal O/L relay	Pr. 9	Pr. 51	109
Stall prevention	Pr. 22	Pr. 48	85
Applied motor	Pr. 71	Pr. 450	111



#### NOTE

- When the RT signal is on, the above second function is selected at the same time.
- Changing the terminal assignment using *Pr. 178 to Pr. 184 (input terminal function selection)* may affect the other functions. Make setting after confirming the function of each terminal.



#### Parameters referred to

*Pr. 178 to Pr. 184 (input terminal function selection)* Refer to page 131



#### 4.11.4 Start signal operation selection (STF, STR, STOP signal, Pr. 250)

You can select the operation of the start signal (STF/STR).

Used to select the stopping method (deceleration to a stop or coasting) when the start signal turns off.

Used to stop the motor with a mechanical brake, etc. together with switching off of the start signal.

(Refer to page 124 for stop selection)

Parameter Number	Name	Initial Value	Setting Range	Description	
				Start signal (STF/STR)	Stop operation <i>Refer to page 124</i>
250	Stop selection	9999	0 to 100s	STF signal: Forward rotation start STR signal: Reverse rotation start	The motor is coasted to a stop when the preset time elapses after the start signal is turned off.
			1000s to 1100s	STF signal: Start signal STR signal: Forward/reverse signal	When the setting is any of 1000s to 1100s, the inverter coasts to a stop in (Pr. 250 - 1000)s.
			9999	STF signal: Forward rotation start STR signal: Reverse rotation start	When the start signal is turned off, the motor decelerates to stop.
			8888	STF signal: Start signal STR signal: Forward/reverse signal	

The above parameters can be set when Pr. 160 User group read selection = "0". (Refer to page 180)

##### (1) Two-wire type connection (STF, STR signal)

- The two-wire connection is shown below.
- In the default setting, the forward/reverse rotation signals (STF/STR) are used as start and stop signals. Turn on either of the forward and reverse rotation signals to start the motor in the corresponding direction. Switch on both or switch off (or both on) the start signal during operation to decelerate the inverter to a stop.
- The speed setting signal may either be given by entering 0 to 10VDC across the speed setting input terminal 2-5, by setting the required values in Pr. 4 to Pr. 6 Multi-speed setting (high, middle, low speeds), etc.  
(For multi-speed operation, refer to page 95.)
- When Pr. 250 is set to any of "1000 to 1100, 8888", the STF signal becomes a start command and the STR signal a forward/reverse command.

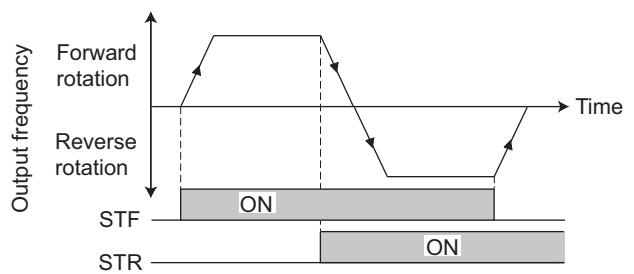
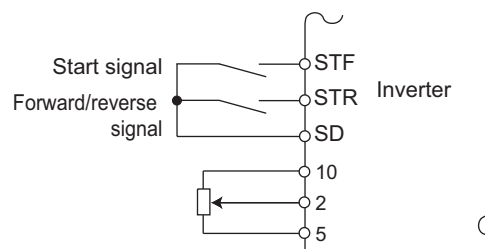
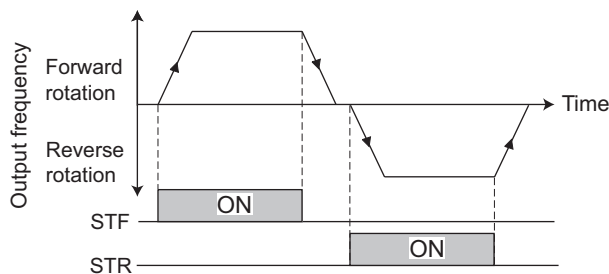
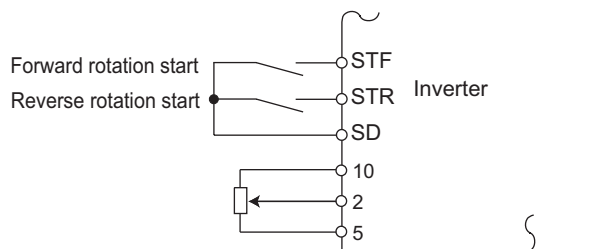

#### REMARKS

- When Pr. 250 is set to any of "0 to 100, 1000 to 1100", turning off the start command coasts the inverter to a stop. (Refer to page 124)
- The STF and STR signals are assigned to the STF and STR terminals in the default setting. The STF signal can be assigned to Pr. 178 STF terminal function selection, and the STR signal to Pr. 179 STR terminal function selection only.

## (2) Three-wire type (STF, STR, STOP signal)

- The three-wire connection is shown below.
- Turning the STOP signal on makes start self-holding function valid. In this case, the forward/reverse rotation signal functions only as a start signal.
- If the start signal (STF or STR) is turned on and then off, the start signal is held and makes a start. When changing the direction of rotation, turn STR (STF) on once and then off.
- To stop the inverter, turning off the STOP signal once decelerates it to a stop.
- When using the STOP signal, set "25" in Pr.178 to Pr.184 (output terminal function selection) to assign function to the output terminal.

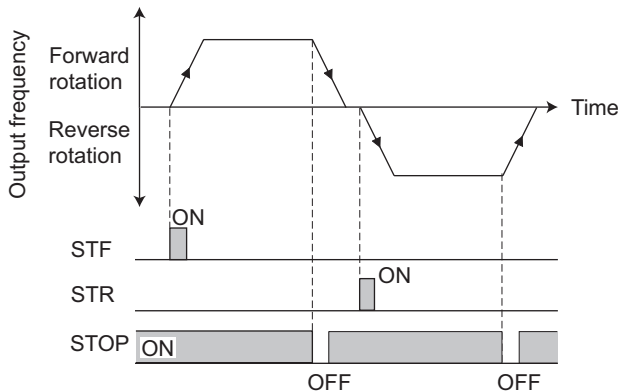
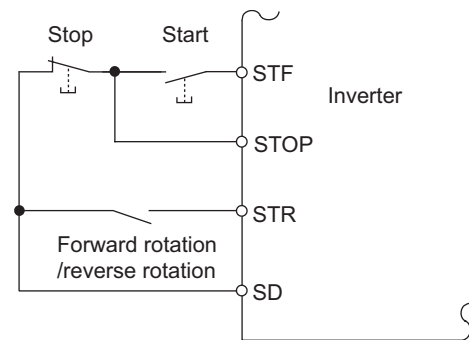
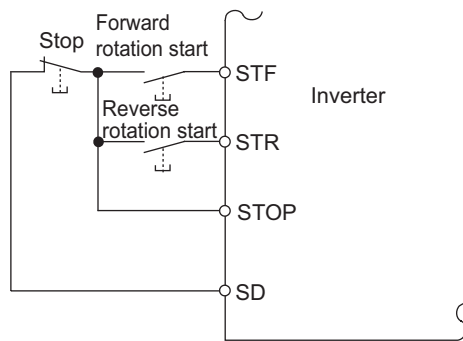

3-wire connection example (Pr. 250 = "9999")

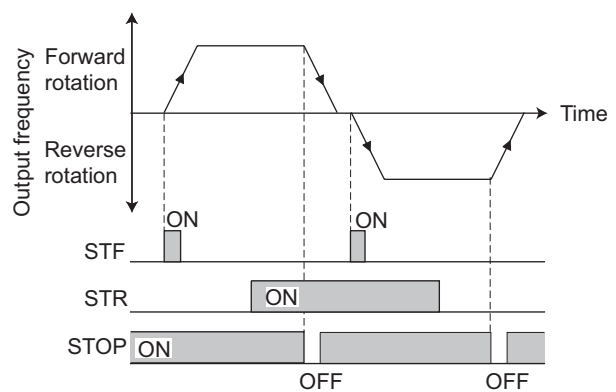

3-wire connection example (Pr. 250 = "8888")

### REMARKS

- When the JOG signal is turned on to enable jog operation, the STOP signal becomes invalid.
- If the MRS signal is turned on to stop the output, the self-holding function is not canceled.

## (3) Start signal selection

STF	STR	Pr. 250 Setting Inverter Status	
		0 to 100s, 9999	1000s to 1100s 8888
OFF	OFF	Stop	Stop
OFF	ON	Reverse rotation	
ON	OFF	Forward rotation	Forward rotation
ON	ON	Stop	Reverse rotation

### Parameters referred to

- Pr. 4 to Pr. 6 (multi-speed setting) Refer to page 95
- Pr. 178 to Pr. 184 (input terminal function selection) Refer to page 131

### 4.11.5 Output terminal function selection (Pr. 190 to Pr. 192)

You can change the functions of the open collector output terminal and relay output terminal.

Parameter Number	Name	Initial Value	Initial Signal	Setting Range
190	RUN terminal function selection	0	RUN (inverter running)	0, 1, 3, 4, 7, 8, 11 to 16, 20, 25, 26, 46, 47, 64, 90, 91, 93, 95, 96, 98, 99, 100, 101, 103, 104, 107, 108, 111 to 116, 120, 125, 126, 146, 147, 164, 190, 191, 193, 195, 196, 198, 199, 9999
191	FU terminal function selection		FU (output frequency detection)	
192	A,B,C terminal function selection	99	ALM (fault output)	0, 1, 3, 4, 7, 8, 11 to 16, 20, 25, 26, 46, 47, 64, 90, 91, 95, 96, 98, 99, 100, 101, 103, 104, 107, 108, 111 to 116, 120, 125, 126, 146, 147, 164, 190, 191, 195, 196, 198, 199, 9999

The above parameters can be set when Pr. 160 User group read selection = "0". (Refer to page 180)

#### (1) Output signal list

- You can set the functions of the output terminals.
- Refer to the following table and set the parameters: (0 to 99: positive logic, 100 to 199: negative logic)

Setting		Signal	Function	Operation	Related Parameter	Refer to Page
Positive logic	Negative logic					
0	100	RUN	Inverter running	Output during operation when the inverter output frequency rises to or above Pr. 13 Starting frequency.	—	139
1	101	SU	Up to frequency *1	Output when the output frequency is reached to the set frequency.	Pr. 41	141
3	103	OL	Overload alarm	Output while stall prevention function is activated.	Pr. 22, Pr. 23, Pr. 66	85
4	104	FU	Output frequency detection	Output when the output frequency reaches the frequency set in Pr. 42 (Pr. 43 for reverse rotation).	Pr. 42, Pr. 43	141
7	107	RBP	Regenerative brake pre-alarm	Output when 85% of the regenerative brake duty set in Pr. 70 is reached.	Pr. 70	122
8	108	THP	Electronic thermal O/L relay pre-alarm	Output when the electronic thermal value reaches 85% of the trip level. (Electronic thermal relay function protection (E.THT/E.THM) activates, when the value reached 100%.	Pr. 9, Pr. 51	109
11	111	RY	Inverter operation ready	Output when reset process is completed (when the inverter can be started by switching the start signal on or while it is running) after powering on inverter.	—	139
12	112	Y12	Output current detection	Output when the output current is higher than the Pr. 150 setting for longer than the time set in Pr. 151.	Pr. 150, Pr. 151	142
13	113	Y13	Zero current detection	Output when the output power is lower than the Pr. 152 setting for longer than the time set in Pr. 153.	Pr. 152, Pr. 153	142
14	114	FDN	PID lower limit	Output when the feedback value falls below the lower limit of PID control.	Pr. 127 to Pr. 134	234
15	115	FUP	PID upper limit	Output when the feedback value rises above the upper limit of PID control		
16	116	RL	PID forward/reverse rotation output	Output when forward rotation is performed in PID control.		
20	120	BOF	Brake opening request	Output to open the brake when the brake sequence function is selected.	Pr. 278 to Pr. 283, Pr. 292	127
25	125	FAN	Fan fault output	Output at the time of a fan fault.	Pr. 244	250
26	126	FIN	Heatsink overheat pre-alarm	Output when the heatsink temperature reaches about 85% of the heatsink overheat protection providing temperature.	—	277
46	146	Y46	During deceleration at occurrence of power failure	Output when the power failure-time deceleration function is executed. (retained until release)	Pr. 261	160
47	147	PID	During PID control activated	Output during PID control.	Pr. 127 to Pr. 134	234
64	164	Y64	During retry	Output during retry processing.	Pr. 65 to Pr. 69	162

Setting		Signal	Function	Operation	Related Parameter	Refer to Page
Positive logic	Negative logic					
90	190	Y90	Life alarm	Output when any of the control circuit capacitor, main circuit capacitor and inrush current limit circuit or the cooling fan approaches the end of its service life.	Pr. 255 to Pr. 259	251
91	191	Y91	Fault output 3 (power-off signal)	Output when a fault occurs due to the internal circuit failure of the inverter wiring mistake.	—	140
93	193	Y93	Current average value monitor signal	Average current value and maintenance timer value are output as pulses. The signal can not be set in <i>Pr. 192 A,B,C terminal function selection</i> .	Pr. 555 to Pr. 557	256
95	195	Y95	Maintenance timer signal	Output when <i>Pr. 503</i> rises to or above the <i>Pr. 504</i> setting.	Pr. 503, Pr. 504	255
96	196	REM	Remote output	Output to the terminal when a value is set to the parameter.	Pr. 495 to Pr. 497	144
98	198	LF	Alarm output	Output when an alarm (fan failure or communication error warning) occurs.	Pr. 121, Pr. 244	203, 250
99	199	ALM	Fault output	Output when the fault occurs. The signal output is stopped when the fault is reset.	—	140
9999		—	No function	—	—	—

\*1 Note that when the frequency setting is varied using an analog signal or  of the operation panel, the output of the SU (up to frequency) signal may alternate on and off depending on that varying speed and the timing of the varying speed due to acceleration/deceleration time setting.  
(The output will not alternate on and off when the acceleration/deceleration time setting is "0s".)

### REMARKS

- The same function may be set to more than one terminal.
- When the function is executed, the terminal conducts at the setting of any of "0 to 99", and does not conduct at the setting of any of "100 to 199".

### NOTE

- Changing the terminal assignment using *Pr.190 to Pr.192 (output terminal function selection)* may affect the other functions. Make setting after confirming the function of each terminal.
- Do not assign signals which repeat frequent ON/OFF to A, B, and C. Otherwise, the life of the relay contact decreases.

(2) Inverter operation ready signal (RY signal) and inverter running signal (RUN signal)

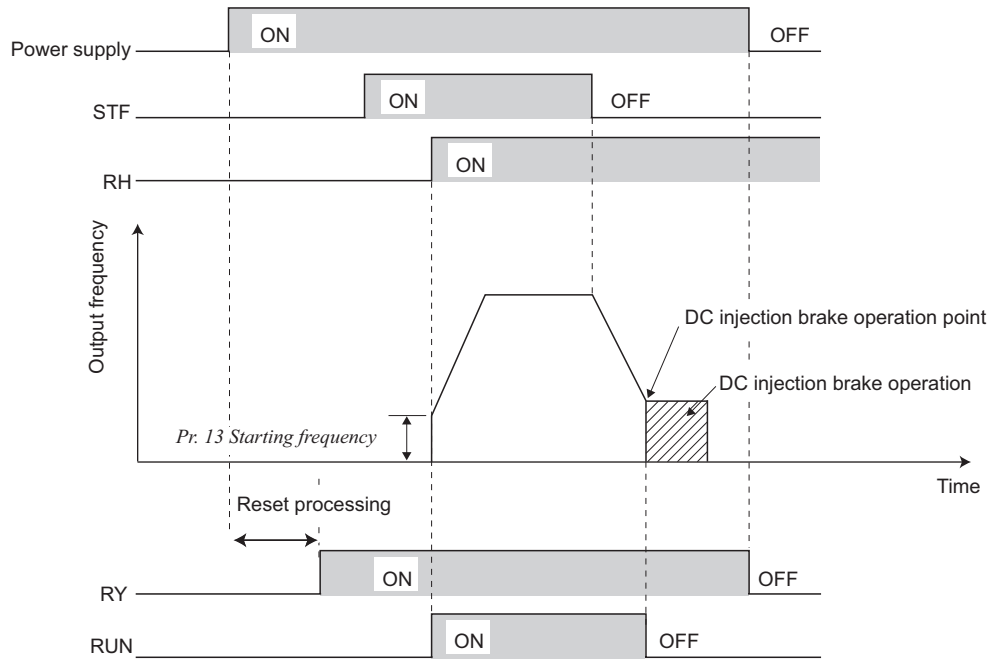

- When the inverter is ready to operate, the output of the operation ready signal (RY) is on. (It is also on during inverter running.)
- When the output frequency of the inverter rises to or above *Pr. 13 Starting frequency* , the output of the inverter running signal (RUN) is turned on. During an inverter stop or DC injection brake operation, the output is off.
- When using the RY and RUN signals, assign functions to *Pr.190 to Pr.192 (output terminal selection function)* referring to the table below.

Output Signal	Pr. 190 to Pr. 192 Setting	
	Positive logic	Negative logic
RY	11	111
RUN	0	100

Inverter Status / Output signal	Start Signal OFF (during stop)	Start Signal ON (during stop)	Start Signal ON (during operation)	Under DC Injection Brake	at Alarm Occurrence or MRS Signal ON (output shutoff)	Automatic Restart after Instantaneous Power Failure		
						Coasting		Restarting
						Start signal ON	Start signal OFF	
RY	ON	ON	ON	ON	OFF	ON *1		ON
RUN	OFF	OFF	ON	OFF	OFF	OFF		ON

\*1 This signal turns OFF during power failure or undervoltage.

**REMARKS**

- The RUN signal (positive logic) is assigned to the terminal RUN in the initial setting.

### (3) Fault output signal (ALM signal)

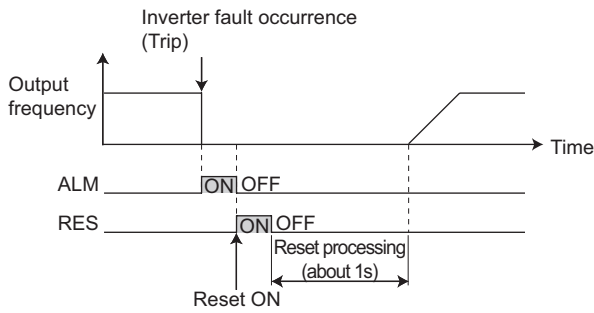

- If the inverter comes to trip, the ALM signal is output.



#### REMARKS

- The ALM signal is assigned to the ABC contact in the default setting. By setting "99 (positive logic) or 199 (negative logic) in Pr.190 to Pr.192 (output terminal function selection), the ALM signal can be assigned to the other signal.
- Refer to page 272 for the inverter fault description.

### (4) Fault output 3 (power-off signal) (Y91 signal)

- The Y91 signal is output at occurrence of a fault attributable to the failure of the inverter circuit or a fault caused by a wiring mistake.
- When using the Y91 signal, set "91 (positive logic)" or "191 (negative logic)" to any of Pr.190 to Pr.192 (output terminal function selection) to assign the function to the output terminal.
- The following table indicates the faults that will output the Y91 signal. (Refer to page 271 for the fault description.)

Operation Panel Indication		Name
E. bE	E. BE	Brake transistor alarm detection
E. GF	E.GF	Output side earth (ground) fault overcurrent
E. LF	E.LF	Output phase loss
E. PE	E.PE	Parameter storage device fault
E.PE2	E.PE2	Internal board fault
E. 6/ E. 7/ E.CPU	E. 6/ E. 7/ E.CPU	CPU fault
E.IOH	E.IOH	Inrush current limit circuit fault



#### REMARKS

- At occurrence of output side earth (ground) fault overcurrent (E.GF), overcurrent trip during acceleration(E.OC1) may be displayed. At this time, the Y91 signal is output.



#### Parameters referred to

Pr. 13 Starting frequency Refer to page 105

### 4.11.6 Detection of output frequency (SU, FU signal, Pr. 41 to Pr. 43)

The inverter output frequency is detected and output at the output signals.

Parameter Number	Name	Initial Value	Setting Range	Description
41	Up-to-frequency sensitivity	10%	0 to 100%	Level where the SU signal turns on.
42	Output frequency detection	6Hz	0 to 400Hz	Frequency where the FU signal turns on.
43	Output frequency detection for reverse rotation	9999	0 to 400Hz	Frequency where the FU signal turns on in reverse rotation.
			9999	Same as Pr. 42 setting

The above parameters can be set when Pr. 160 User group read selection = "0". (Refer to page 180)

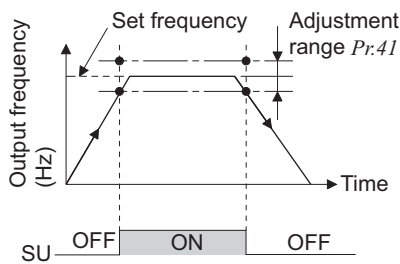

#### (1) Up-to-frequency sensitivity (SU signal, Pr. 41)

- When the output frequency reaches the set frequency, the up-to-frequency signal (SU) is output.
- The Pr. 41 value can be adjusted within the range 0% to  $\pm 100\%$  on the assumption that the set frequency is 100%.
- This parameter can be used to ensure that the running frequency has been reached to provide the operation start signal etc. for related equipment.
- When using the SU signal, set "1 (positive logic) or 101 (negative logic)" in Pr. 190 to Pr. 192 (output terminal function selection) to assign function to the output terminal.

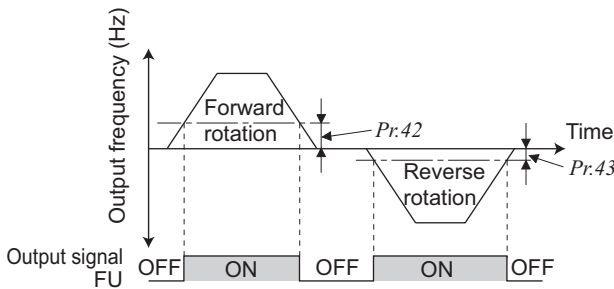

#### (2) Output frequency detection (FU signal, Pr. 42, Pr. 43)

- The output frequency detection signal (FU) is output when the output frequency reaches or exceeds the Pr. 42 setting.
- This function can be used for electromagnetic brake operation, open signal, etc.
- When the detection frequency is set to Pr. 43, frequency detection for reverse operation use only can also be set. This function is effective for switching the timing of electromagnetic brake operation between forward rotation (rise) and reverse rotation (fall) during vertical lift operation, etc.
- When Pr. 43  $\neq$  "9999", the Pr. 42 setting is used for forward rotation and the Pr. 43 setting is used for reverse rotation.

#### REMARKS

- The FU signal is assigned to the terminal FU in the initial setting. The FU signal can also be assigned to the other terminal by setting "4 (positive logic) or 104 (negative logic)" in any of Pr. 190 to Pr. 192.
- All signals are off during DC injection brake.
- The output frequency to be compared with the set frequency is the output frequency before slip compensation is performed.

#### NOTE

- Changing the terminal assignment using Pr.190 to Pr.192 (output terminal function selection) may affect the other functions. Make setting after confirming the function of each terminal.

#### Parameters referred to

Pr. 190 to Pr. 192 (output terminal function selection) (Refer to page 137)

## 4.11.7 Output current detection function (Y12 signal, Y13 signal, Pr. 150 to Pr. 153)

The output current during inverter running can be detected and output to the output terminal.

Parameter Number	Name	Initial Value	Setting Range	Description
150	Output current detection level	150%	0 to 200%	Output current detection level. 100% is the rated inverter current.
151	Output current detection signal delay time	0s	0 to 10s	Output current detection period. The time from when the output current has risen above the setting until the output current detection signal (Y12) is output.
152	Zero current detection level	5%	0 to 200%	Zero current detection level. The rated inverter current is assumed to be 100%.
153	Zero current detection time	0.5s	0 to 1s	Period from when the output current drops below the Pr. 152 value until the zero current detection signal (Y13) is output.

The above parameters can be set when Pr. 160 User group read selection = "0". (Refer to page 180)

Pr. 166 ≠ 9999, Pr. 167 = 0

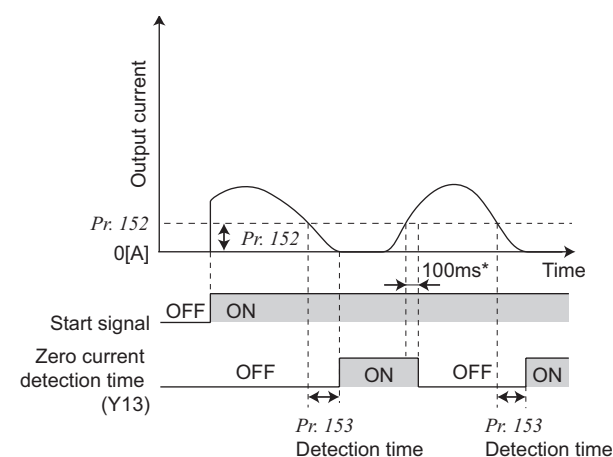
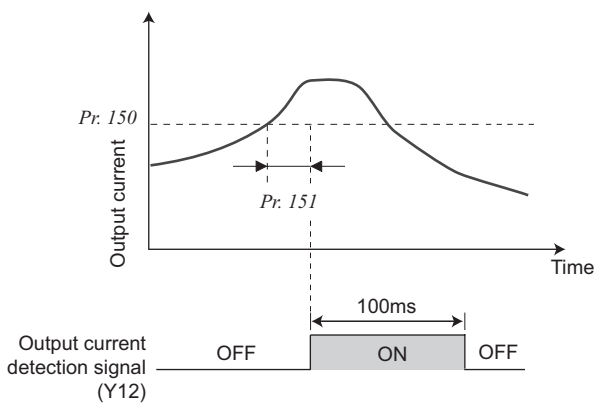

\* The zero current detection signal (Y13) holds the signal for approximately 100ms once turned on.

### (1) Output current detection (Y12 signal, Pr. 150, Pr. 151)

- The output current detection function can be used for excessive torque detection, etc.
- If the output current remains higher than the Pr. 150 setting during inverter operation for longer than the time set in Pr. 151, the output current detection signal (Y12) is output from the inverter's open collector or relay output terminal.
- When the Y12 signal turns on, the ON state is held for approximately 100ms.
- For the Y12 signal, set "12 (positive logic) or 112 (negative logic)" in Pr. 190 to Pr. 192 (output terminal function selection) and assign functions to the output terminal.

### (2) Zero current detection (Y13 signal, Pr. 152, Pr. 153)

- If the output current remains lower than the Pr. 152 setting during inverter operation for longer than the time set in Pr. 153, the zero current detection (Y13) signal is output from the inverter's open collector or relay output terminal.
- When the inverter's output current falls to "0", torque will not be generated. This may cause a drop due to gravity when the inverter is used in vertical lift application. To prevent this, the Y13 signal can be output from the inverter to close the mechanical brake when the output current has fallen to "zero".
- For the Y13 signal, set "13 (positive logic) or 113 (negative logic)" in Pr. 190 to Pr. 192 (output terminal function selection) and assign functions to the output terminal.

### REMARKS



- This function is also valid during execution of the online auto tuning.
- The response time of Y12 and Y13 signals is approximately 0.1s. Note that the response time changes according to the load condition. When Pr. 152 = "0", detection is disabled.

### NOTE

- Changing the terminal assignment using Pr. 190 to Pr. 192 (output terminal function selection) may affect the other functions. Make setting after confirming the function of each terminal.



 **CAUTION**

-  The zero current detection level setting should not be too high, and the zero current detection time setting not too long. Otherwise, the detection signal may not be output when torque is not generated at a low output current.
-  To prevent the machine and equipment from resulting in hazardous conditions detection signal, install a safety backup such as an emergency brake even the zero current detection function is set valid.



**Parameters referred to**

Offline auto tuning  Refer to page 113

Pr. 190 to Pr. 192 (output terminal function selection)  Refer to page 137

## 4.11.8 Remote output selection (REM signal, Pr. 495 to Pr. 497)

You can utilize the on/off of the inverter's output signals instead of the remote output terminal of the programmable logic controller.

Parameter Number	Name	Initial Value	Setting Range	Description
495	Remote output selection	0	0	Remote output data clear at powering off
			1	Remote output data retention at powering off
			10	Remote output data clear at powering off
			11	Remote output data retention at powering off
496*	Remote output data 1	0	0 to 4095	Refer to the following diagram.
497*	Remote output data 2	0	0 to 4095	

The above parameters can be set when Pr. 160 User group read selection = "0". (Refer to page 180)

\* The above parameters allow its setting to be changed during operation in any operation mode even if "0" (initial value) is set in Pr. 77 Parameter write selection.

### <Remote output data>

Pr. 496

b11											b0
*1	*1	*1	*1	*1	*1	ABC	FU	*1	*1	*1	RUN

Pr. 497

b11											b0
*1	*1	RA3*3	RA2*3	RA1*3	Y6*2	Y5*2	Y4*2	Y3*2	Y2*2	Y1*2	Y0*2

\*1 Any

\*2 Y0 to Y6 are available only when the extension output option (FR-A7AY E kit) is fitted

\*3 RA1 to RA3 are available only when the relay output option (FR-A7AR E kit) is fitted

- The output terminal can be turned on/off depending on the Pr. 496 or Pr. 497 setting. The remote output selection can be controlled on/off by computer link communication from the PU connector or RS-485 port or by communication from the communication option.
- Set "96 (positive logic) or 196 (negative logic)" to any of Pr. 190 to Pr. 192 (output terminal function selection), and assign the remote output (REM) signal to the terminal used for remote output.
- When you refer to the diagram on the left and set 1 to the terminal bit (terminal where the REM signal has been assigned) of Pr. 496 or Pr. 497, the output terminal turns on (off for negative logic). By setting 0, the output terminal turns off (on for negative logic).

Example: When "96 (positive logic)" is set in Pr. 190 RUN terminal function selection and "1" (H01) is set in Pr. 496, the terminal RUN turns on.

### ON/OFF example for positive logic

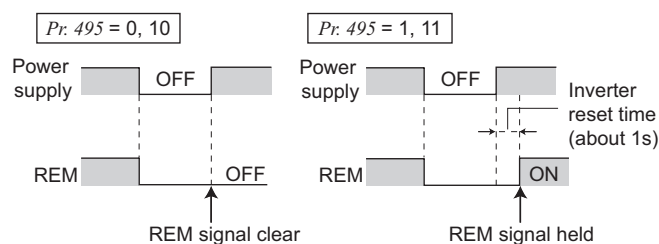

- When Pr. 495 = "0" (initial value), performing a power on reset (including a power failure) clears the REM signal output. (The ON/OFF status of the terminals are as set in Pr. 190 to Pr. 192. ) The Pr. 496 and Pr. 497 settings are also "0". When Pr. 495 = "1, 11", the remote output data before power off is stored into the EEPROM, so the signal output at power recovery is the same as before power off. However, it is not stored when the inverter is reset (terminal reset, reset request through communication). (See the chart on the left)
- When Pr. 495 = "10, 11", signal before rest is saved even at inverter reset.

### REMARKS

- The output terminal where the REM signal is not assigned using any of Pr. 190 to Pr. 192 does not turn on/off if 0/1 is set to the terminal bit of Pr. 496 or Pr. 497. (It turns on/off with the assigned function.)
- When the inverter is reset (terminal reset, reset request through communication), Pr. 496 and Pr. 497 values turn to "0". When Pr. 495 = "1, 11", however, they are the settings at power off. (The settings are stored at power off.) When Pr. 495 = "10, 11", they are the same as before an inverter reset is made.



### Parameters referred to

Pr. 190 to Pr. 192 (output terminal function selection) Refer to page 137

## 4.12 Monitor display and monitor output signal

Purpose	Parameter that should be Set		Refer to Page
Display motor speed Set speed	Speed display and speed setting	Pr. 37	145
Change PU monitor display data	DU/PU main display data selection Cumulative monitor clear	Pr. 52, Pr. 54, Pr. 170, Pr. 171, Pr. 268, Pr. 563, Pr. 564	146
Change the monitor output from terminal AM	Terminal AM function selection	Pr. 158	146
Set the reference of the monitor output from terminal AM	Terminal AM standard setting	Pr. 55, Pr. 56	151
Adjust terminal AM outputs	Terminal AM calibration	Pr. 645, Pr. 901	152

### 4.12.1 Speed display and speed setting (Pr. 37)

The monitor display and frequency setting of the PU (FR-PU04/FR-PU07) can be changed to the machine speed.

Parameter Number	Name	Initial Value	Setting Range	Description
37	Speed display	0	0	Frequency display, setting
			0.01 to 9998*	Machine speed at 60Hz.

The above parameters can be set when Pr. 160 User group read selection = "0". (Refer to page 180)

\* The maximum value of the setting range differs according to the Pr. 1 Maximum frequency and it can be calculated from the following formula.

$$\text{Maximum setting value of Pr. 37} < \frac{16777.215 \times 60 \text{ (Hz)}}{\text{Setting value of Pr. 1 (Hz)}}$$

Note that the maximum setting value of Pr. 37 is 9998 if the result of the above formula exceeds 9998.

- To display the machine speed, set in Pr. 37 the machine speed for 60Hz operation.  
For example, when Pr. 37 = "1000", "1000" is displayed on the running speed monitor when the running frequency is 60Hz. When running frequency is 30Hz, "500" is displayed.

Pr. 37 Setting	Output Frequency Monitor	Set Frequency Monitor	Frequency Setting Parameter Setting
0 (initial value)	Hz	Hz	Hz
0.01 to 9998	Machine speed *1	Machine speed *1	

\*1 Machine speed conversion formula ..... Pr. 37 × frequency/60Hz

\*2 Hz is displayed in 0.01Hz increments and machine speed is in 0.001.



#### NOTE

- Under V/F control, the output frequency of the inverter is displayed in terms of synchronous speed, and therefore, displayed value = actual speed + motor slip. The display changes to the actual speed (estimated value calculated based on the motor slip) when advanced magnetic flux vector control was selected or slip compensation was made valid.
- Refer to Pr. 52 when you want to change the PU main monitor (PU main display).
- Since the panel display of the operation panel is 4 digits in length, the monitor value of more than "9999" is displayed "----".
- When the machine speed is displayed on the FR-PU04/FR-PU07, do not change the speed by using an up/down key in the state where the set speed exceeding 65535 is displayed. The set speed may become arbitrary value.
- While the machine speed is displayed on the monitor, values of other parameters related to speed (Pr. 1, etc.) are in frequency increments.
- Due to the limitations on the resolution of the set frequency, the indication in the second decimal place may differ from the setting.
- When frequency or set frequency is monitored from network option card except for FR-A7NC E kit, frequency is displayed for monitor description regardless of Pr. 37 setting.



## CAUTION





Make sure that the running speed setting is correct.  
Otherwise, the motor might run at extremely high speed, damaging the machine.



#### Parameters referred to

Pr. 1 Maximum frequency  Refer to page 89

Pr. 52 DU/PU main display data selection  Refer to page 146

Pr. 800 Control method selection  Refer to page 76

### 4.12.2 Monitor display selection of DU/PU and terminal AM (Pr. 52, Pr.158, Pr. 170, Pr. 171, Pr. 268, Pr. 563, Pr. 564)

The monitor to be displayed on the main screen of the control panel and parameter unit (FR-PU04/FR-PU07) can be selected.

In addition, signal to be output from the terminal AM (analog voltage output) can be selected.

Parameter Number	Name	Initial Value	Setting Range	Description
52 *	DU/PU main display data selection	0 (output frequency)	0, 5, 7 to 12, 14, 20, 23 to 25, 52 to 57, 61, 62, 100	Select the monitor to be displayed on the operation panel and parameter unit. Refer to the following table for monitor description.
158 *	AM terminal function selection	1 (output frequency)	1 to 3, 5, 7 to 12, 14, 21, 24, 52, 53, 61, 62	Select the monitor output to terminal AM.
170	Watt-hour meter clear	9999	0	Set "0" to clear the watt-hour meter monitor.
			10	Set the maximum value when monitoring from communication to 0 to 9999kWh.
			9999	Set the maximum value when monitoring from communication to 0 to 65535kWh.
171	Operation hour meter clear	9999	0, 9999	Set "0" in the parameter to clear the operation time monitor. Setting 9999 does not clear.
268 *	Monitor decimal digits selection	9999	0	Displayed as integral value
			1	Displayed in 0.1 increments.
			9999	No function
563	Energization time carrying-over times	0	0 to 65535 (reading only)	The numbers of cumulative energization time monitor exceeded 65535h is displayed. (Reading only)
564	Operating time carrying-over times	0	0 to 65535 (reading only)	The numbers of operation time monitor exceeded 65535h is displayed. (Reading only)

The above parameters can be set when Pr. 160 User group read selection = "0". (Refer to page 180)

\* The above parameters allow its setting to be changed during operation in any operation mode even if "0" (initial value) is set in Pr. 77 Parameter write selection.

#### (1) Monitor description list (Pr. 52)

- Set the monitor to be displayed on the operation panel and parameter unit (FR-PU04/FR-PU07) in Pr. 52 DU/PU main display data selection .
- Set the monitor to be output to the terminal AM (analog voltage output) in Pr. 158 AM terminal function selection .
- Refer to the following table and set the monitor to be displayed. (The monitor marked cannot be selected.)

Types of Monitor	Unit	Pr. 52 Setting		Pr.158 (AM) Setting	Terminal AM Full Scale Value	Description
		Operation panel LED	PU main monitor			
Output frequency	0.01Hz	0/100		1	Pr. 55	Displays the inverter output frequency.
Output current	0.01A	0/100		2	Pr. 56	Displays the inverter output current effective value.
Output voltage	0.1V	0/100		3	200V class 400V 400V class 800V	Displays the inverter output voltage.
Fault display	—	0/100		×	—	Displays 8 past faults individually.
Frequency setting value	0.01Hz	5	*1	5	Pr. 55	Displays the set frequency.
Motor torque	0.1%	7	*1	7	Rated torque of the applied motor ×2	Displays the motor torque in % on the assumption that the rated motor torque is 100%. (Displays 0% during V/F control)
Converter output voltage	0.1V	8	*1	8	200V class 400V 400V class 800V	Displays the DC bus voltage value.
Regenerative brake duty	0.1%	9	*1	9	Pr. 70	Brake duty set in Pr. 30, Pr. 70

Types of Monitor	Unit	Pr. 52 Setting		Pr.158 (AM) Setting	Terminal AM Full Scale Value		Description
		Operation panel LED	PU main monitor				
Electronic thermal relay function load factor	0.1%	10	*1	10	100%		Displays the thermal cumulative value on the assumption that the thermal operation level is 100% (Larger thermal between the motor thermal and transistor thermal).
Output current peak value	0.01A	11	*1	11	Pr. 56		Holds and displays the peak value of the output power monitor. (Cleared at every start)
Converter output voltage peak value	0.1V	12	*1	12	200V class	400V	Holds and displays the peak value of the DC bus voltage value. (Cleared at every start)
					400V class	800V	
Output power	0.01kW	14	*1	14	Rated inverter power × 2		Displays the power on the inverter output side
Input terminal status	—	—	*1	×	—		Displays the input terminal ON/OFF status on the PU. (Refer to page 149 for DU display)
Output terminal status	—		*1	×	—		Displays the output terminal ON/OFF status on the PU. (Refer to page 149 for DU display)
Cumulative energization time *2, *5	1h	20		×	—		Adds up and displays the energization time after inverter shipment. You can check the numbers of the monitor value exceeded 65535h with Pr. 563.
Reference voltage output	—	—		21	—		Terminal AM: Output 10V
Actual operation time *2, *3, *5	1h	23		×	—		Adds up and displays the inverter operation time. You can check the numbers of the monitor value exceeded 65535h with Pr. 564. Can be cleared by Pr. 171. (Refer to page 150)
Motor load factor	0.1%	24		24	200%		Displays the output current value on the assumption that the inverter rated current value is 100%. Monitor value = output power monitor value/rated inverter current 100 [%]
Cumulative energization power *5	0.01kWh *4	25		×	—		Adds up and displays the power amount based on the output power monitor. Can be cleared by Pr. 170. (Refer to page 150)
PID set point	0.1%	52		52	100%		Displays the set point, measured value and deviation during PID control (Refer to page 238 for details)
PID process value	0.1%	53		53	100%		
PID deviation	0.1%	54		×	—		
Inverter I/O terminal monitor	—	55	×	×	—		Displays the ON/OFF status of the inverter input terminal and output terminal on the operation panel (Refer to page 149 for details)
Option input terminal status	—	56	×	×	—		Displays the input terminal ON/OFF status of the digital input option (FR-A7AX E Kit) on the operation panel. (Refer to page 149 for details)
Option output terminal status	—	57	×	×	—		Displays the output terminal ON/OFF status of the digital output option (FR-A7AY E kit) or relay output option (FR-A7AR E Kit) on the operation panel (Refer to page 149 for details).
Motor thermal load factor	0.1%	61		61	Thermal relay operation level (100%)		Motor thermal heat cumulative value is displayed. (Motor overload trip (E.THM) at 100%)
Inverter thermal load factor	0.1%	62		62	Thermal relay operation level (100%)		Transistor thermal heat cumulative value is displayed. (Inverter overload trip (E.THT) at 100%)

## Monitor display and monitor output signal

- \*1 Frequency setting to output terminal status on the PU main monitor are selected by "other monitor selection" of the parameter unit (FR-PU04V/FR-PU07).
- \*2 The cumulative energization time and actual operation time are accumulated from 0 to 65535 hours, then cleared, and accumulated again from 0. When the operation panel is used, the time is displayed up to 65.53 (65530h) on the assumption that 1h = 0.001, and thereafter, it is added up from 0.
- \*3 Actual operation time is not accumulated when the cumulative operation time is less than 1h until turning off of the power supply.
- \*4 When using the parameter unit (FR-PU04/FR-PU07), "kW" is displayed.
- \*5 Since the panel display of the operation panel is 4 digits in length, the monitor value of more than "9999" is displayed "----".
- \*6 Larger thermal value between the motor thermal and transistor thermal is displayed.  
A value other than 0% is displayed if the ambient temperature (heatsink temperature) is high even when the inverter is at a stop.

### REMARKS

- By setting "0" in Pr. 52, the monitoring of output speed to fault display can be selected in sequence by **SET**.
- When the operation panel is used, the displayed units are Hz and A only and the others are not displayed.
- The monitor set in Pr. 52 is displayed in the third monitor position. However, change the output current monitor for the motor load factor.

#### Initial Value

\*The monitor displayed at powering on is the first monitor. Display the monitor you want to display on the first monitor and hold down **SET** for 1s. (To return to the output frequency monitor, hold down **SET** for 1s after displaying the output frequency monitor.)

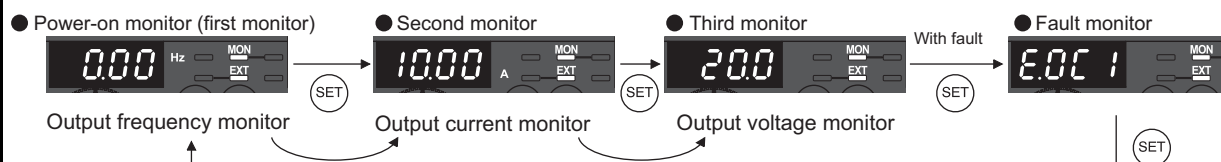

Example) When Pr. 52 is set to "20" (cumulative energization time), the monitor is displayed on the operation panel as described below.

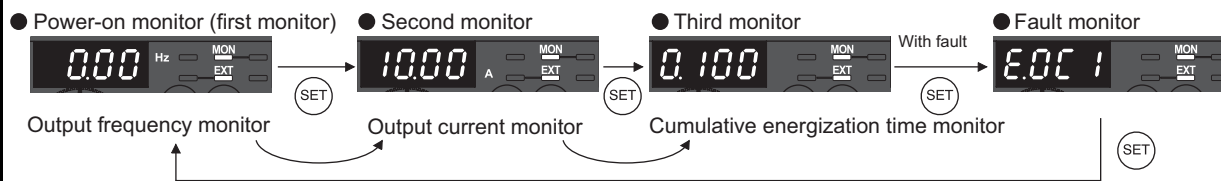

### (2) Display set frequency during stop (Pr. 52)

- When "100" is set in Pr. 52, the set frequency and output frequency are displayed during stop and operation respectively. (LED of Hz flickers during stop and is lit during operation.)

	Pr. 52		
	0	100	
	During running/stop	During stop	During running
Output frequency	Output frequency	Set frequency*	Output frequency
Output current	Output current		
Output voltage	Output voltage		
Fault display	Fault display		

\* The set frequency displayed indicates the frequency to be output when the start command is on. Different from the frequency setting displayed when Pr. 52 = "5", the value based on maximum/minimum frequency and frequency jump is displayed.

### REMARKS

- During an error, the output frequency at error occurrence appears.
- During MRS signal is on, the values displayed are the same as during a stop.
- During offline auto tuning, the tuning status monitor has priority.

**(3) Operation panel I/O terminal monitor (Pr. 52)**

- When Pr. 52 is set to any of "55 to 57", the I/O terminal status can be monitored on the operation panel.
- The I/O terminal monitor is displayed on the third monitor.
- The LED is on when the terminal is on, and the LED is on when the terminal is off. The center line of LED is always on.

Pr. 52 Setting	Monitor Description
55	Displays the I/O and output terminal ON/OFF status of the inverter unit.
56 *	Displays the input terminal ON/OFF status of the digital input option (FR-A7AX E kit).
57 *	Displays the output terminal ON/OFF status of the digital output option (FR-A7AY E kit) or relay output option (FR-A7AR E kit).

\* You can set "56" or "57" if the option is not fitted. When the option is not fitted, the monitor displays are all off.

- On the unit I/O terminal monitor (Pr. 52 = "55"), the upper LEDs denote the input terminal status and the lower the output terminal status.

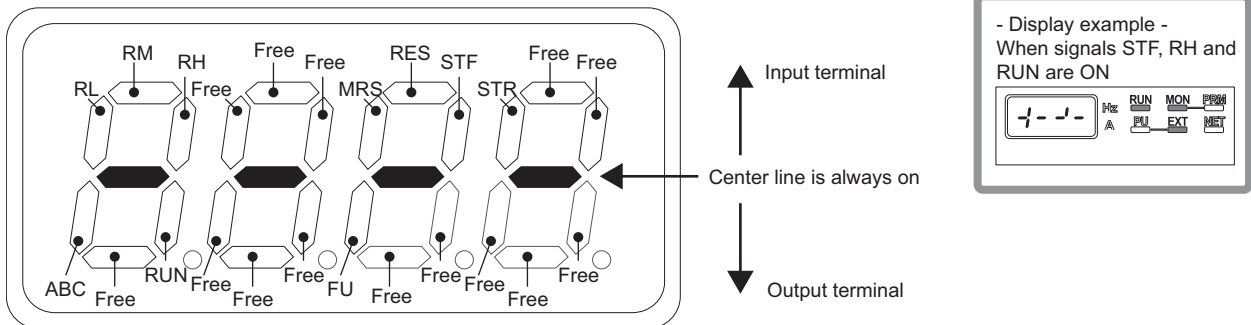

- On the input option kit terminal monitor (Pr. 52 = "56"), the decimal point LED of the first digit LED is on.

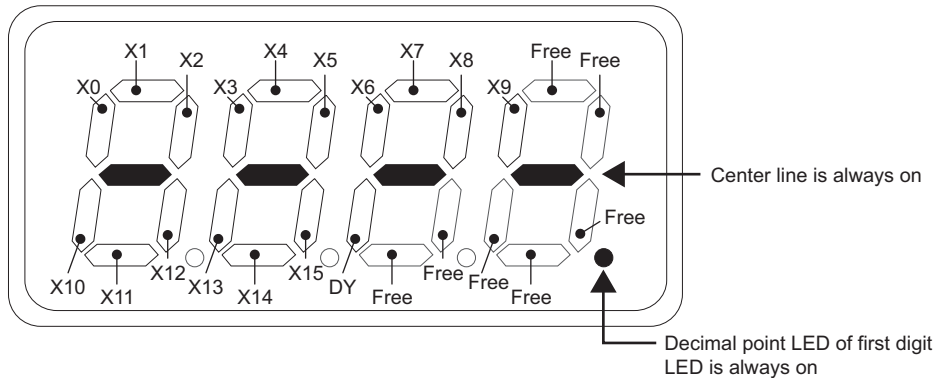

- On the output option terminal monitor (Pr. 52 = "57"), the decimal point LED of the second digit LED is on.

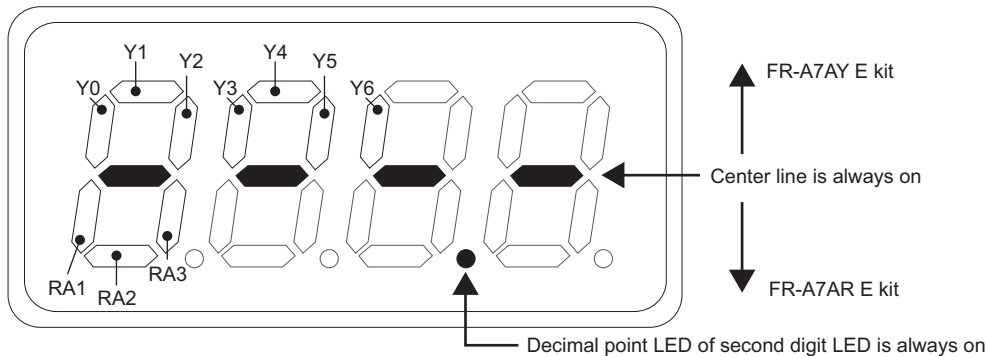

### (4) Cumulative energization power monitor and clear (Pr. 170)

- On the cumulative energization power monitor (Pr. 52 = "25"), the output power monitor value is added up and is updated in 1h increments.
- The operation panel, parameter unit (FR-PU04/FR-PU07) and communication (RS-485 communication, communication option) display increments and display ranges are as indicated below.

Operation Panel *1		Parameter Unit *2		Communication		
Range	Unit	Range	Unit	Range		Unit
				Pr. 170 = 10	Pr. 170 = 9999	
0 to 99.99kWh	0.01kWh	0 to 999.99kWh	0.01kWh	0 to 9999kWh	0 to 65535kWh (initial value)	1kWh
100.0 to 999.9kWh	0.1kWh	1000.0 to 9999.9kWh	0.1kWh			
1000 to 9999kWh	1kWh	10000 to 99999kWh	1kWh			

- \*1 Power is measured in the range 0 to 9999.99kWh, and displayed in 4 digits.  
When the monitor value exceeds "99.99", a carry occurs, e.g. "100.0", so the value is displayed in 0.1kWh increments.
- \*2 Power is measured in the range 0 to 99999.99kWh, and displayed in 5 digits.  
When the monitor value exceeds "999.99", a carry occurs, e.g. "1000.0", so the value is displayed in 0.1kWh increments.

- Writing "0" to Pr. 170 clears the cumulative energization power monitor.

#### REMARKS

- If "0" is written to Pr. 170 and Pr. 170 is read again, "9999" or "10" is displayed.

### (5) Cumulative energization time and actual operation time monitor (Pr. 171, Pr. 563, Pr. 564)

- Cumulative energization time monitor (Pr. 52 = "20") accumulates energization time from shipment of the inverter every one hour.
- On the actual operation time monitor (Pr. 52 = "23"), the inverter running time is added up every hour. (Time is not added up during a stop.)
- If the monitored value exceeds 65535, it is added up from 0. You can check the numbers of cumulative energization time monitor exceeded 65535h with Pr. 563 and the numbers of actual operation time monitor exceeded 65535h with Pr. 564.
- Writing "0" to Pr. 171 clears the cumulative energization power monitor. (The cumulative time monitor can not be cleared.)

#### REMARKS

- The actual operation time is not added up unless the inverter is operated one or more hours continuously.
- If "0" is written to Pr. 171 and Pr. 171 is read again, "9999" is always displayed. Setting "9999" does not clear the actual operation time meter.

### (6) You can select the decimal digits of the monitor (Pr. 268)



- As the operation panel display is 4 digits long, the decimal places may vary at analog input, etc. The decimal places can be hidden by selecting the decimal digits.  
In such a case, the decimal digits can be selected by Pr. 268.

Pr. 268 Setting	Description
9999 (initial value)	No function
0	For the first or second decimal places (0.1 increments or 0.01 increments) of the monitor, numbers in the first decimal place and smaller are rounded to display an integral value (1 increments). The monitor value smaller than 0.99 is displayed as 0.
1	When 2 decimal places (0.01 increments) are monitored, the 0.01 decimal place is dropped and the monitor displays the first decimal place (0.1 increments). The monitored digits in 1 increments are displayed as they are.

#### REMARKS

- The number of display digits on the cumulative energization time (Pr. 52 = "20") and actual operation time (Pr. 52 = "23") does not change.

#### Parameters referred to

- Pr. 30 Regenerative function selection, Pr. 70 Special regenerative brake duty  Refer to page 122  
Pr. 37 Speed display, Pr. 144 Speed setting switchover  Refer to page 145  
Pr. 55 Frequency monitoring reference, Pr. 56 Current monitoring reference  Refer to page 151



4.12.3 Reference of the terminal AM (analog voltage output) (Pr. 55, Pr. 56)

Analog voltage output from the terminal AM is available.  
Set the reference of the signal output from terminal AM.

Parameter Number	Name	Initial Value	Setting Range	Description
55*	Frequency monitoring reference	60Hz	0 to 400Hz	Full-scale value to output the output frequency monitor value to terminal AM.
56*	Current monitoring reference	Inverter rated current	0 to 500A	Full-scale value to output the output current monitor value to terminal AM.

The above parameters can be set when Pr. 160 User group read selection = "0". (Refer to page 180)

\* The above parameters allow its setting to be changed during operation in any operation mode even if "0" (initial value) is set in Pr. 77 Parameter write selection.

(1) Frequency monitoring reference (Pr. 55)

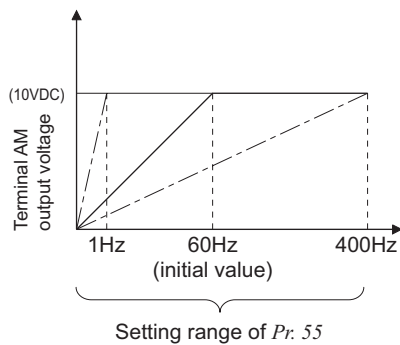

- Set the frequency to be referenced when the frequency monitor (output frequency/set frequency) is selected for the terminal AM display.
- Set the frequency (output frequency/set frequency) when the voltage output at terminal AM is 10VDC.
- The analog voltage output and frequency at terminal AM are proportional. (The maximum output voltage is 10VDC.)

(2) Current monitoring reference (Pr. 56)

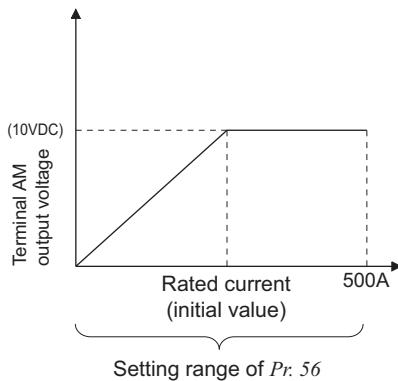

- Set the current to be referenced when the current monitor (inverter output current, etc.) is selected for terminal AM display.
- Set the current value when the voltage output at terminal AM is 10VDC.
- The analog voltage output and current value at terminal AM are proportional. (The maximum output voltage is 10VDC.)

## 4.12.4 Terminal AM calibration (calibration parameter Pr. 645, C1 (Pr.901))

By using the operation panel or parameter unit, you can calibrate terminal AM to full scale deflection.

Parameter Number	Name	Initial Value	Setting Range	Description
645	AM 0V adjustment	1000	970 to 1200	Calibrates the scale of the meter when analog output is 0.
C1(901)	AM terminal calibration	—	—	Calibrates the scale of the meter connected to terminal AM.

\*1 The above parameters can be set when Pr. 160 User group read selection = "0". (Refer to page 180)

\*2 The parameter number in parentheses is the one for use with the operation panel (PA02) for the FR-E500 series or parameter unit (FR-PU04/FR-PU07).

\*3 The above parameters allow its setting to be changed during operation in any operation mode even if "0" (initial value) is set in Pr. 77 Parameter write selection.

### (1) Terminal AM bias calibration

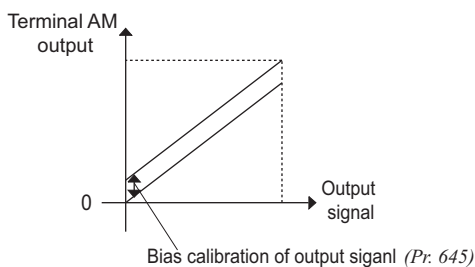

- Use Pr. 645 AM 0V adjustment to calibrate the bias side output signal from terminal AM.
- If the meter needle does not point to 0 when the analog output from terminal AM is 0, add or decrease the Pr. 645 setting to adjust the meter needle points to 0.
- When changing  $\pm 1$  in Pr. 645, the analog output changes about  $\pm 5\text{mV}$ .  
(Analog output will not become lower than about  $-100\text{mV}$  even when setting the Pr. 645 lower.)



#### NOTE

- Calibration bias and gain changes when changing the control circuit terminal block. Use Pr. 645 and C1(Pr. 901) to calibrate again in that case.
- If bias calibration (Pr. 645) is performed, make sure to perform gain calibration (C1(Pr. 901)) too.

### (2) Terminal AM gain calibration (C1 (Pr. 901))

- Terminal AM is factory-set to provide a 10VDC output in the full-scale status of the corresponding monitor item. Calibration parameter C1 (Pr. 901) allows the output voltage ratios (gains) to be adjusted according to the meter scale. Note that the maximum output voltage is 10VDC.

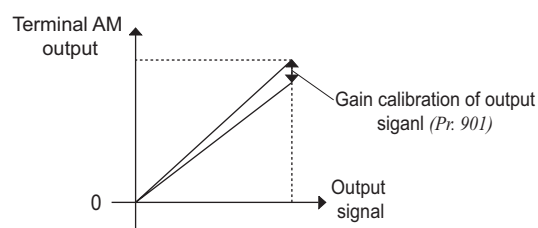
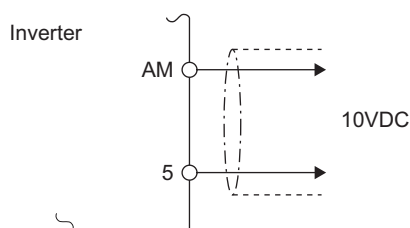

- Calibrate the terminal AM gain in the following procedure.
  - Connect a 0-10VDC meter (frequency meter) to across inverter terminals AM-5. (Note the polarity. The terminal AM is positive.)
  - Refer to the monitor description list (page 146) and set Pr. 158.  
When you selected the running frequency, inverter output current, etc. as monitor, preset in Pr. 55 or Pr. 56 the running frequency or current value at which the output signal will be 10V.
  - When outputting the item that cannot achieve a 100% value easily by operation, e.g. output current, set "21" (reference voltage output) in Pr. 158 and perform the following operation. After that, set "2" (output current, for example) in Pr. 158.



#### REMARKS

- When outputting such an item as the output current, which cannot reach a 100% value easily by operation, set Pr. 158 to "21" (reference voltage output) and make calibration. 10VDC is output from the terminal AM.

(3) How to calibrate the terminal AM when using the operation panel

Operation

1. Confirmation of the RUN indication and operation mode indication
2. Press **(MODE)** to choose the parameter setting mode.
3. Turn until **[ . . . ]** appears.
4. Turn **(SET)** until **[ - - - ]** appears.
5. Turn until **[ ! ]** appears.  
Set to *C1 AM terminal calibration*.
6. Press **(SET)** to enable setting.
7. If the inverter is at a stop, press the **(RUN)** key to start the inverter.  
(Motor needs not be connected.)
8. Turn to adjust the indicator needle to the desired position.
9. Press **(SET)**.  
Setting is complete.

Display

(When Pr. 158 = 1)

PRM indication is lit.  
(The parameter number read previously appears.)

**(MODE)** ⇒ **[ P. 0 ]**

⇒ **[ . . . ]** (C0 to C7 setting is enabled.)

**(SET)** ⇒ **[ - - - ]**

⇒ **[ ! ]**

**(SET)** ⇒ **[ 0.00 ]** Hz (The monitor set to Pr. 158 AM terminal function selection is displayed.)

**(RUN)** ⇒ **[ 0.00 ]** Hz, **[ MON ]**, **[ PU ]**

⇒ Analog indicator

**(SET)** ⇒ **[ 6000 ]** Hz, **[ ! ]**

Flicker...Parameter setting complete!!

- Turn to read another parameter.
- Press **(SET)** to return to the **[ - - - ]** indication (step 4).
- Press **(SET)** twice to show the next parameter (**[ Pr. [ ] ]**).

**REMARKS**

- Calibration can also be made for external operation. Set the frequency in the external operation mode, and make calibration in the above procedure.
- Calibration can be made even during operation.
- For operation from the parameter unit (FR-PU04/FR-PU07), refer to the instruction manual of the parameter unit.

**Parameters referred to**

- Pr. 55 Frequency monitoring reference Refer to page 151
- Pr. 56 Current monitoring reference Refer to page 151
- Pr. 158 AM terminal function selection Refer to page 146

## 4.13 Operation selection at power failure and instantaneous power failure

Purpose	Parameter that should be Set		Refer to Page
At instantaneous power failure occurrence, restart inverter without stopping motor	Automatic restart operation after instantaneous power failure/flying start	Pr. 30, Pr. 57, Pr. 58, Pr. 96, Pr. 162, Pr. 165, Pr. 298, Pr. 299, Pr. 611	154
When undervoltage or a power failure occurs, the inverter can be decelerated to a stop.	Power failure-time deceleration-to-stop function	Pr. 261	160

### 4.13.1 Automatic restart after instantaneous power failure/flying start (Pr. 30, Pr. 57, Pr. 58, Pr. 96, Pr. 162, Pr. 165, Pr. 298, Pr. 299, Pr. 611)

You can restart the inverter without stopping the motor in the following cases:

- When power comes back on after an instantaneous power failure
- When motor is coasting at start

Parameter Number	Name	Initial Value	Setting Range	Description
30	Regenerative function selection	0	0, 1	The motor starts at the starting frequency when MRS (X10) turns on then off
			2	Restart operation is performed when MRS (X10) turns on then off
57	Restart coasting time	9999	0	FR-E720-080 or less, FR-E740-040 or less .... 1s FR-E720-110 to 330, FR-E740-060 to 170..... 2s FR-E720-470 or more..... 3s The above times are coasting time.
			0.1 to 5s	Waiting time for inverter-triggered restart after an instantaneous power failure.
			9999	No restart
58	Restart cushion time	1s	0 to 60s	Voltage starting time at restart.
96	Auto tuning setting/status	0	0	Offline auto tuning is not performed
			1	Advanced magnetic flux vector control Offline auto tuning is performed without motor running (all motor constants) (Refer to page 79)
			11	For general-purpose magnetic flux vector control Offline auto tuning is performed without motor running (motor constants (R1) only) (Refer to page 82)
			21	Offline auto tuning (tuning performed without motor running) for V/F control and automatic restart after instantaneous power failure (with frequency search)
162	Automatic restart after instantaneous power failure selection	1	0	With frequency search
			1	Without frequency search (reduced voltage system)
			10	Frequency search at every start
			11	Reduced voltage at every start
165	Stall prevention operation level for restart	150%	0 to 200%	Considers the rated inverter current as 100% and sets the stall prevention operation level during restart operation.
298	Frequency search gain	9999	0 to 32767	When offline auto tuning is performed under V/F control, frequency search gain necessary for frequency search for automatic restart after instantaneous power failure is set as well as the motor constants (R1).
			9999	Uses the Mitsubishi motor (SF-JR, SF-HR, SF-JRCA, SF-HRCA) constants
299	Rotation direction detection selection at restarting	0	0	Without rotation direction detection
			1	With rotation direction detection
			9999	When Pr. 78 = 0, With rotation direction detection When Pr. 78 = 1, 2 Without rotation direction detection
611	Acceleration time at a restart	5s	0 to 3600s	Acceleration time to reach the acceleration time reference frequency at a restart.
			9999	Acceleration time for restart is the normal acceleration time (e.g. Pr. 7)

The above parameters can be set when Pr. 160 User group read selection = "0". (Refer to page 180)

**When Pr. 162 = 1, 11 (without frequency search)**

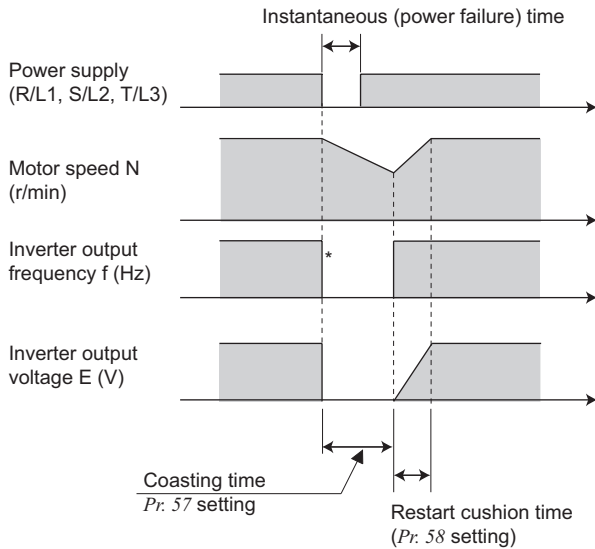

\* The output shut off timing differs according to the load condition.

**When Pr. 162 = 0, 10 (with frequency search)**

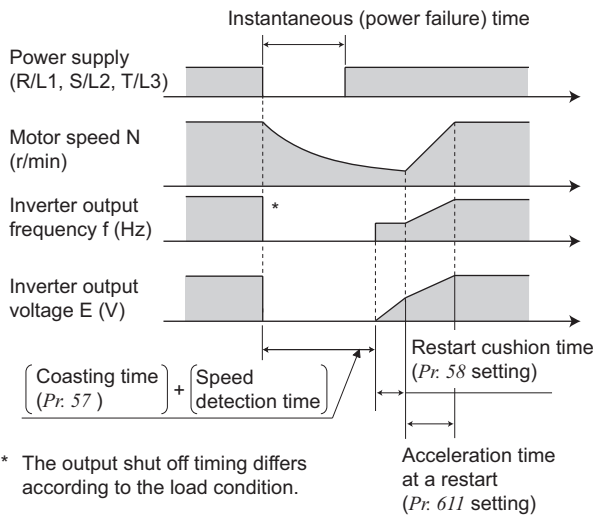

\* The output shut off timing differs according to the load condition.

**(1) Automatic restart operation selection**

(Pr. 30, Pr. 162, Pr. 299)

**Without frequency search**

When Pr. 162 = "1" or "11", automatic restart operation is performed in a reduced voltage system, where the voltage is gradually risen with the output frequency unchanged from prior to an instantaneous power failure independently of the coasting speed of the motor.

**REMARKS**

- This system stores the output frequency and rotation direction prior to an instantaneous power failure and restart using the stored value. Therefore, if the instantaneous power failure time exceeds 0.2s and the stored value cannot be retained, the inverter starts at Pr. 13 Starting frequency (initial value = 0.5Hz) in the starting direction upon power restoration.

**With frequency search**

When "0 (initial value) or 10" is set in Pr. 162, the inverter smoothly starts after detecting the motor speed upon power restoration. (The motor capacity should be equal to or one rank lower than the inverter capacity)

When using the frequency search, perform offline auto tuning.

(Refer to page 113 for advanced magnetic flux vector, general-purpose magnetic flux vector control and page 157 for V/F control.)

- During reverse rotation, the inverter can be restarted smoothly as the direction of rotation is detected.
- You can select whether to make rotation direction detection or not with Pr. 299 Rotation direction detection selection at restarting.

When capacities of the motor and inverter differ, set "0" (without rotation direction detection) in Pr. 299.

Pr. 299 Setting	Pr. 78 Setting		
	0	1	2
9999	○	×	×
0 (initial value)	×	×	×
1	○	○	○

○: the rotation direction is detected.

×: the rotation direction is not detected.

**REMARKS**

- Speed detection time (frequency search) changes according to the motor speed. (maximum 100ms)
- When the inverter capacity is two rank or more larger than the motor capacity, the inverter may not start due to overcurrent trip (E.OC□).
- If two or more motors are connected to one inverter, the inverter functions abnormally. (The inverter does not start smoothly.)
- When reverse rotation is detected when Pr. 78 = "1" (reverse rotation disabled), the rotation direction is changed to forward rotation after decelerates in reverse rotation when the start command is forward rotation. The inverter will not start when the start command is reverse rotation.



## NOTE

- When automatic restart operation after instantaneous power failure is activated while the motor is running at a low speed (less than 10Hz), the motor restarts in the direction prior to instantaneous power failure without detecting the rotation direction (*Pr: 299 Rotation direction detection selection at restarting = "1"*).
- If the frequency search result exceeds the set frequency, the output frequency is limited at the set frequency.
- When the wiring length exceeds below, select without frequency search (*Pr: 162 = "1, 11"*).

Motor capacity	0.1K	0.2K	0.4K or more
Wiring length	20m (65.61feet)	50m (164.04feet)	100m (323.08feet)

### ● Restart operation at every start

When *Pr: 162 = "10" or "11"*, automatic restart operation is also performed every start, in addition to the automatic restart after instantaneous power failure. When *Pr: 162 = "0"*, automatic restart operation is performed at the first start after power supply-on, but not performed at the second time or later.

### ● Automatic restart operation selection of MRS (X10) signal

Restart operation after turning MRS (X10) signal on then off using *Pr: 30* can be selected as in the table below. When automatic restart after instantaneous power failure is selected when using the high power factor converter (FR-HC), normally set "2" in *Pr: 30*.

Pr. 30 Setting	Operation after MRS and X10 Signal Turns off, on, then off.
0, 1	Start at the <i>Pr: 13 Starting frequency</i> .
2	Frequency search is made and starts at the coasting speed.

## (2) Restart coasting time (*Pr: 57*)

- Coasting time is the time from when the motor speed is detected until automatic restart control is started.
- Set *Pr: 57* to "0" to perform automatic restart operation.

The coasting time is automatically set to the value below. Generally this setting will pose no problems.

FR-E720-080 or less, FR-E740-040 or less ..... 1s

FR-E720-110 to 330, FR-E740-060 to 170 ..... 2s

FR-E720-470 or more ..... 3s

- Operation may not be performed well depending on the magnitude of the moment of inertia (J) of the load or running frequency. Adjust the coasting time between 0.1s and 5s according to the load specifications.

## (3) Restart cushion time (*Pr: 58*)

- Cushion time is the length of time when the voltage appropriate to the voltage at the detected motor speed (output frequency prior to instantaneous power failure when *Pr: 162 = "1, 11"*) from 0V.
- Normally the initial value need not be changed for operation, but adjust it according to the magnitude of the moment of inertia (J) of the load or torque.

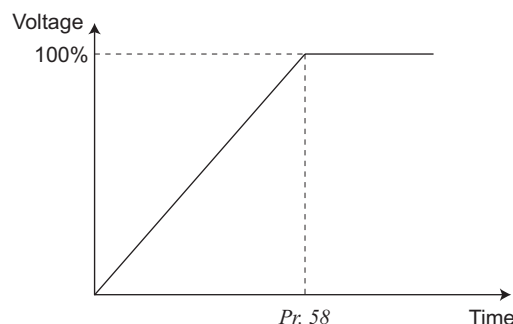

## (4) Automatic restart operation adjustment (*Pr: 165, Pr: 611*)

- Using *Pr: 165*, you can set the stall prevention operation level at a restart.
- Using *Pr: 611*, you can set the acceleration time to the acceleration time reference frequency when automatic restart operation is performed besides the normal acceleration time.



## REMARKS

- If the *Pr: 21 Acceleration/deceleration time increments* is changed, the setting increments of *Pr: 611* remain unchanged.

**(5) Frequency search gain (Pr. 298), offline auto tuning (Pr. 96)**

- When automatic restart after instantaneous power failure operation (with frequency search) is valid at V/F control, perform offline auto tuning.
- Perform offline auto tuning during V/F control in the following order to set Pr. 298 Frequency search gain automatically. (Refer to page 113 during advanced magnetic flux vector control and general-purpose magnetic flux vector control.)

**●Before performing offline auto tuning**

Check the following before performing offline auto tuning.

- The inverter is under V/F control
- A motor should be connected. Note that the motor should be at a stop at a tuning start.
- The motor capacity should be equal to or one rank lower than the inverter capacity. (note that the capacity is 0.1kW or more)
- The maximum frequency is 120Hz.
- A high-slip motor, high-speed motor and special motor cannot be tuned.
- Even if tuning is performed without motor running (Pr. 96 Auto tuning setting/status = "21"), the motor may run slightly. Therefore, fix the motor securely with a mechanical brake, or before tuning, make sure that there will be no problem in safety if the motor runs (caution is required especially in vertical lift applications). Note that tuning performance is unaffected even if the motor runs slightly.
- Offline auto tuning will not be performed properly if it is performed with a surge voltage suppression filter (FR-ASFH, FR-BMF-H) connected between the inverter and motor. Remove it before starting tuning.

**●Setting**

1) Set "21" in Pr. 96 Auto tuning setting/status.

Tuning is performed without motor running.

It takes approximately 9s \* until tuning is completed.

(Excitation noise is produced during tuning.)

\*Tuning time differs according to the inverter capacity and motor type.

2) Set the rated motor current (initial value is rated inverter current) in Pr. 9 Electronic thermal O/L relay. (Refer to page 109)

3) Set Pr. 71 Applied motor according to the motor used.

Motor	Pr.71 Setting *1	
Mitsubishi standard motor Mitsubishi high efficiency motor	SF-JR	3
	SF-JR 4P 1.5kW or less	23
	SF-HR	43
	Others	3
Mitsubishi constant-torque motor	SF-JRCA 4P	13
	SF-HRCA 4P	53
	Others (SF-JRC, etc.)	13
Other manufacturer's standard motor	—	3
Other manufacturer's constant torque motor	—	13

\*1Refer to page 111, for other settings of Pr. 71.

## ● Execution of tuning



### POINT

Before performing tuning, check the monitor display of the operation panel or parameter unit (FR-PU04/FR-PU07) if the inverter is in the status for tuning. (Refer to 2) below)

- When performing PU operation, press of the operation panel.  
For external operation, turn on the start command (STF signal or STR signal). Tuning starts.



### NOTE

- To force tuning to end, use the MRS or RES signal or press of the operation panel. (Turning the start signal (STF signal or STR signal) off also ends tuning.)
- During offline auto tuning, only the following I/O signals are valid: (initial value)
  - Input terminal <Valid signal> MRS, RES, STF, STR
  - Output terminal RUN, AM, A, B, C
 Note that the progress status of offline auto tuning is output in eight steps from AM when speed and output frequency are selected.
- Since the RUN signal turns on when tuning is started, caution is required especially when a sequence which releases a mechanical brake by the RUN signal has been designed.
- When executing offline auto tuning, input the run command after switching on the main circuit power (R/L1, S/L2, T/L3) of the inverter.
- Do not perform ON/OFF switching of the second function selection signal (RT) during execution of offline auto tuning. Auto tuning is not executed properly.

- Monitor is displayed on the operation panel and parameter unit (FR-PU04, FR-PU07) during tuning as below.

	Parameter Unit (FR-PU04, FR-PU07)	Operation Panel Indication
Pr. 96 setting	21	21
(1) Setting		
(2) Tuning in progress		
(3) Normal end		Flickering 
(4) Error end (when inverter protective function operation is activated)		

- Reference: Offline auto tuning time (when the initial value is set)

Offline Auto Tuning Setting	Time
Tune motor constants (R1) only (Pr. 96 = "21")	Approx. 9s (Tuning time differs according to the inverter capacity and motor type.)

- When offline auto tuning ends, press of the operation panel during PU operation. For external operation, turn off the start signal (STF signal or STR signal) once.  
This operation resets the offline auto tuning and the PU's monitor display returns to the normal indication.  
(Without this operation, next operation cannot be started.)



### REMARKS

- Do not change the Pr. 96 setting after completion of tuning (23).  
If the Pr. 96 setting is changed, tuning data is made invalid.  
If the Pr. 96 setting is changed, tuning must be performed again.



- 4) If offline auto tuning ended in error (see the table below), motor constants are not set.  
Perform an inverter reset and restart tuning.

Error Display	Error Cause	Remedy
8	Forced end	Set "21" in Pr. 96 and perform tuning again.
9	Inverter protective function operation	Make setting again.
91	Current limit (stall prevention) function was activated.	Set "1" in Pr. 156.
92	Converter output voltage reached 75% of rated value.	Check for fluctuation of power supply voltage.
93	Calculation error A motor is not connected.	Check the motor wiring and make setting again.

- 5) When tuning is ended forcibly by pressing or turning off the start signal (STF or STR) during tuning, offline auto tuning does not end normally. (The motor constants have not been set.)  
Perform an inverter reset and restart tuning.



### NOTE

- The motor constants measured once in the offline auto tuning are stored as parameters and their data are held until the offline auto tuning is performed again.
- An instantaneous power failure occurring during tuning will result in a tuning error.  
After power is restored, the inverter goes into the normal operation mode. Therefore, when STF (STR) signal is on, the motor runs in the forward (reverse) rotation.
- Any alarm occurring during tuning is handled as in the ordinary mode. Note that if a fault retry has been set, retry is ignored.
- The set frequency monitor displayed during the offline auto tuning is 0Hz.
- Changing the terminal assignment using Pr.178 to Pr.184 (input terminal function selection) may affect the other functions.  
Make setting after confirming the function of each terminal.
- The SU and FU signals are not output during a restart. They are output after the restart cushion time has elapsed.
- Automatic restart operation will also be performed after a reset or when a retry is made by the retry function.



## CAUTION

- When automatic restart after instantaneous power failure has been selected, the motor and machine will start suddenly (after the reset time has elapsed) after occurrence of an instantaneous power failure.  
**Stay away from the motor and machine.**  
When you have selected automatic restart after instantaneous power failure function, apply in easily visible places the CAUTION stickers supplied to the Installation guideline.
- When the start signal is turned off or is pressed during the restart cushion time after instantaneous power failure, deceleration starts after Pr. 58 Restart cushion time has elapsed.



### Parameters referred to

- Pr. 7 Acceleration time, Pr. 21 Acceleration/deceleration time increments Refer to page 102  
Pr. 13 Starting frequency Refer to page 105  
Pr. 65, Pr. 67 to Pr. 69 Retry function Refer to page 162  
Pr. 71 Applied motor Refer to page 111  
Pr. 78 Reverse rotation prevention selection Refer to page 180  
Pr. 178 to Pr. 184 (input terminal function selection) Refer to page 131

## 4.13.2 Power-failure deceleration stop function (Pr. 261)

When a power failure or undervoltage occurs, the inverter can be decelerated to a stop or can be decelerated and re-accelerated to the set frequency.

Parameter Number	Name	Initial Value	Setting Range	Description
261	Power failure stop selection	0	0	Coasts to stop. When undervoltage or power failure occurs, the inverter output is shut off.
			1	When undervoltage or a power failure occurs, the inverter can be decelerated to a stop.
			2	When undervoltage or a power failure occurs, the inverter can be decelerated to a stop. If power is restored during a power failure, the inverter accelerates again.

The above parameters can be set when Pr. 160 User group read selection = "0". (Refer to page 180)

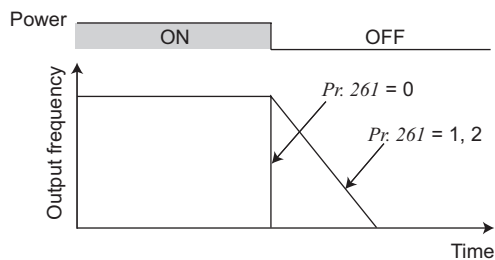

### (1) Parameter setting

- When Pr. 261 is set to "1" or "2", the inverter decelerates to a stop if an undervoltage or power failure occurs.

### (2) Operation outline of deceleration to stop at power failure

- When undervoltage or power failure has occurred, the output frequency is decreased and controlled so that the converter circuit (DC bus) voltage is constant and decreased to 0Hz to stop.

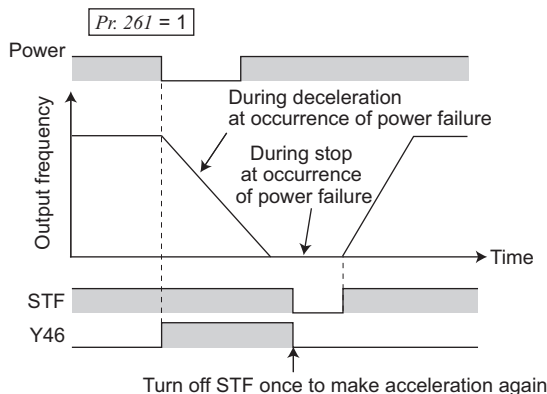

### (3) Power failure stop function (Pr. 261 = "1")

- If power is restored during power failure deceleration, deceleration to a stop is continued and the inverter remains stopped. To restart, turn off the start signal once, then turn it on again.

## REMARKS

- When automatic restart after instantaneous power failure is selected (Pr. 57 ≠ "9999"), power failure stop function is made invalid and automatic restart operation after instantaneous power failure is made valid.
- After a power failure stop, the inverter will not start even if the power is restored with the start signal (STF/STR) input. After switching on the power, turn off the start signal once and then on again to make a start.

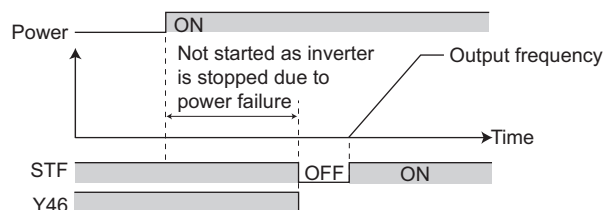

(4) Operation continuation at instantaneous power failure function (Pr. 261 = "2")

- When power is restored during deceleration after a power failure, acceleration is made again up to the set frequency.
- When this function is used in combination with the automatic restart after instantaneous power failure function (Pr. 57 ≠ "9999"), deceleration can be made at a power failure and acceleration can be made again after power restoration.

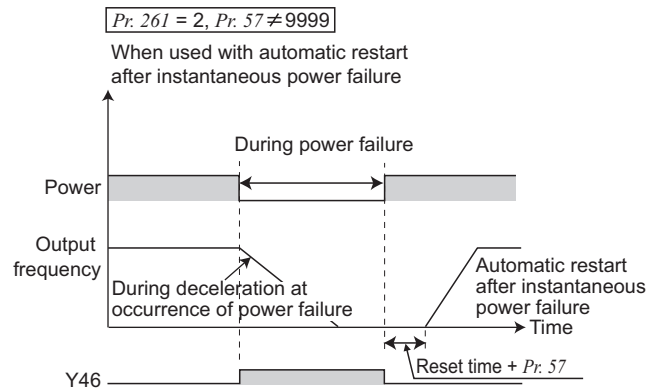
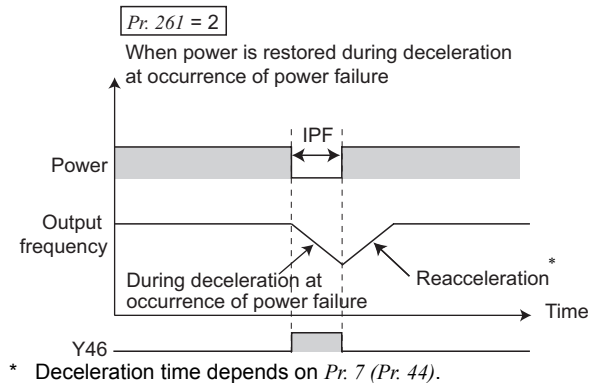

**NOTE**

- When operation continuation at instantaneous power failure function is used, keep the starting signal (STF/STR) on even during instantaneous power failure. If the starting signal turns off during instantaneous power failure, the inverter decelerates according to the deceleration time setting, causing the motor to coast if enough regenerative energy is not obtained.

(5) Power failure deceleration signal (Y46 signal)

- The Y46 signal is on during deceleration at an instantaneous power failure or during a stop after deceleration at an instantaneous power failure.
- After a power failure stop, the inverter can not start even if power is restored the start command is given. In this case, check the power failure deceleration signal (Y46 signal). (at occurrence of input phase loss (E.I.LF), etc.)
- For the Y46 signal, set "46 (forward operation)" or "146 (reverse operation)" to any of Pr. 190 to Pr. 192 (output terminal function selection) to assign the function.



**REMARKS**

- During a stop or trip, the power failure stop selection is not performed.



**NOTE**

- Changing the terminal assignment using Pr. 190 to Pr. 192 (output terminal function selection) may affect the other functions. Please make setting after confirming the function of each terminal.

**CAUTION**



Even if the power failure stop function is valid, some loads may cause the inverter to trip and the motor to coast.

The motor will coast if enough regenerative energy is not given from the motor to the inverter.



**Parameters referred to**

- Pr. 57 Restart coasting time Refer to page 154
- Pr. 190 to Pr. 192 (output terminal function selection) Refer to page 137

## 4.14 Operation setting at fault occurrence

Purpose	Parameter that should be Set		Refer to Page
Recover by retry operation at fault occurrence	Retry operation	Pr. 65, Pr. 67 to Pr. 69	162
Do not output input/output phase failure alarm	Input/output phase failure protection selection	Pr. 251, Pr. 872	164

### 4.14.1 Retry function (Pr. 65, Pr. 67 to Pr. 69)

If a fault occurs, the inverter resets itself automatically to restart. You can also select the fault for a retry. When you have selected automatic restart after instantaneous power failure (Pr. 57 Restart coasting time ≠ 9999), restart operation is performed at the retry operation time which is the same of that of a power failure. (Refer to page 154 for the restart function.)

Parameter Number	Name	Initial Value	Setting Range	Description
65	Retry selection	0	0 to 5	A fault for retry can be selected. (Refer to the next page)
67	Number of retries at fault occurrence	0	0	No retry function
			1 to 10	Set the number of retries at fault occurrence. A fault output is provided during retry operation.
			101 to 110	Set the number of retries at fault occurrence. (The setting value of minus 100 is the number of retries.) A fault output is provided during retry operation.
68	Retry waiting time	1s	0.1 to 360s	Set the waiting time from when an inverter fault occurs until a retry is made.
69	Retry count display erase	0	0	Clear the number of restarts succeeded by retry.

The above parameters can be set when Pr. 160 User group read selection = "0". (Refer to page 180)

#### Retry success example

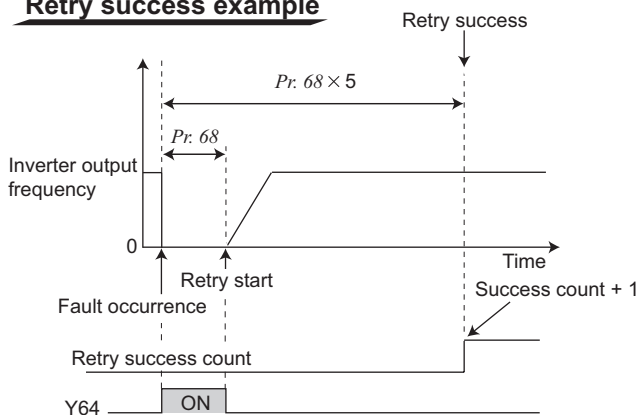

#### Retry failure example

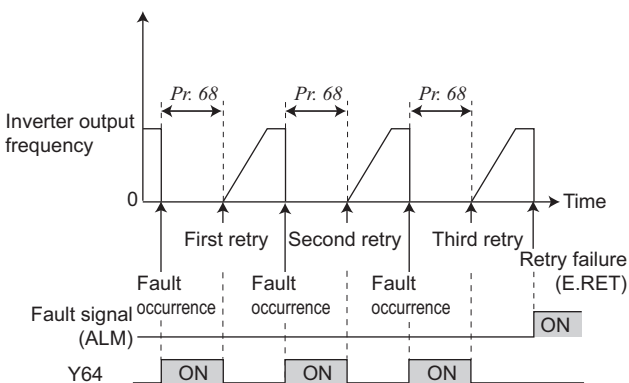

- Retry operation automatically resets a fault and restarts the inverter at the starting frequency when the time set in Pr. 68 elapses after the inverter is tripped.
- Retry operation is performed by setting Pr.67 to any value other than "0". Set the number of retries at fault occurrence in Pr. 67.
- When retries fail consecutively more than the number of times set in Pr. 67, a retry count excess fault (E.RET) occurs, resulting in inverter trip. (Refer to retry failure example)
- Use Pr. 68 to set the waiting time from when the inverter trips until a retry is made in the range 0 to 360s. (When the setting value is "0s", the actual time is 0.1s.)
- Reading the Pr. 69 value provides the cumulative number of successful restart times made by retry. The cumulative count in Pr. 69 is increased by 1 when a retry is regarded as successful after normal operation continues without faults occurring for more than four times longer than the time set in Pr.68 after a retry start. (When retry is successful, cumulative number of retry failure is cleared.)
- Writing "0" to Pr. 69 clears the cumulative count.
- During a retry, the Y64 signal is on. For the Y64 signal, assign the function by setting "64 (positive operation)" or "164 (negative operation)" to any of Pr. 190 to Pr. 192 (output terminal function selection) .

- Using *Pr. 65*, you can select the fault that will cause a retry to be executed. No retry will be made for the fault not indicated. (Refer to *page 272* for the fault description.)
  - indicates the faults selected for retry.

Fault for Retry	<i>Pr. 65</i> Setting					
	0	1	2	3	4	5
E.OC1	●	●		●	●	●
E.OC2	●	●		●	●	
E.OC3	●	●		●	●	●
E.OV1	●		●	●	●	
E.OV2	●		●	●	●	
E.OV3	●		●	●	●	
E.THM	●					
E.THT	●					
E. BE	●				●	
E. GF	●				●	

Fault for Retry	<i>Pr. 65</i> Setting					
	0	1	2	3	4	5
E.USB	●				●	
E.OHT	●					
E.OLT	●				●	
E.OP1	●				●	
E. PE	●				●	
E.MB4	●				●	
E.MB5	●				●	
E.MB6	●				●	
E.MB7	●				●	
E.ILF	●				●	



**NOTE**

- When terminal assignment is changed using *Pr.190 to Pr.192*, the other functions may be affected. Make setting after confirming the function of each terminal.
- The data stored as the error reset for retry is only that of the fault which occurred the first time.
- When an inverter fault is reset by the retry function at the retry time, the accumulated data of the electronic thermal relay function, regeneration brake duty etc. are not cleared. (Different from the power-on reset.)

 **CAUTION**

 When you have selected the retry function, stay away from the motor and machine when the inverter is tripped. They will start suddenly (after the reset time has elapsed) after the inverter trip.  
When you have selected the retry function, apply in easily visible places the CAUTION stickers supplied.



**Parameters referred to**

*Pr. 57 Restart coasting time*  (Refer to *page 154*)

### 4.14.2 Input/output phase loss protection selection (Pr. 251, Pr. 872)

You can disable the output phase loss protection function that trips the inverter if one phase of the inverter output side (load side) three phases (U, V, W) is lost.

The input phase loss protection function of the inverter input side (R/L1, S/L2, T/L3) can be made valid.

Parameter Number	Name	Initial Value	Setting Range	Description
251	Output phase loss protection selection	1	0	Without output phase loss protection
			1	With output phase loss protection
872	Input phase loss protection selection	1	0	Without input phase loss protection
			1	With input phase loss protection

The above parameters can be set when Pr. 160 User group read selection = "0". (Refer to page 180)

#### (1) Output phase loss protection selection (Pr. 251)

- When Pr. 251 is set to "0", output phase loss protection (E.LF) becomes invalid.

#### (2) Input phase loss protection selection (Pr. 872)

- When Pr. 872 is set to "1", input phase loss protection (E.ILF) is provided if a phase loss of one phase among the three phases is detected for 1s continuously.



#### NOTE

- If an input phase loss continues for a long time, the converter section and capacitor lives of the inverter will be shorter.
- As phase loss is detected according to the bus voltage change, it can not be detected if the load is light. Also, if the power supply voltage is imbalanced, phase loss is less likely detected.
- Phase loss can not be detected during regeneration load operation.

### 4.14.3 Earth (ground) fault detection at start (Pr. 249)

You can choose whether to make earth (ground) fault detection at start valid or invalid. Earth (Ground) fault detection is executed only right after the start signal is input to the inverter.

Protective function will not activate if an earth (ground) fault occurs during operation.

Parameter Number	Name	Initial Value	Setting Range	Description
249	Earth (ground) fault detection at start	0	0	Without earth (ground) fault detection
			1	With earth (ground) fault detection

The above parameters can be set when Pr. 160 User group read selection = "0". (Refer to page 180)



#### NOTE

- As detection is executed at starting, output is delayed for approx. 20ms every starting.
- If an earth (ground) fault is detected with "1" set in Pr. 249, output side earth (ground) fault overcurrent (E.GF) is detected and the inverter trips. (Refer to page 277)
- If the motor capacity is smaller than the inverter capacity for the FR-E720-240 or more, FR-E740-120 or more, earth (ground) fault detection may not be provided.

## 4.15 Energy saving operation

Purpose	Parameter that should be Set		Refer to Page
Energy saving operation	Optimum excitation control	Pr. 60	165

### 4.15.1 Optimum excitation control (Pr. 60)

Without a fine parameter setting, the inverter automatically performs energy saving operation.  
This inverter is optimum for fan and pump applications

Parameter Number	Name	Initial Value	Setting Range	Description
60	Energy saving control selection *	0	0	Normal operation mode
			9	Optimum excitation control mode

\* When parameter is read using the FR-PU04, a parameter name different from an actual parameter is displayed.

#### (1) Optimum excitation control mode (setting "9")

- When "9" is set in *Pr. 60*, the inverter operates in the optimum excitation control mode.
- The optimum excitation control mode is a control system which controls excitation current to improve the motor efficiency to maximum and determines output voltage as an energy saving method.



#### REMARKS

- When the motor capacity is too small as compared to the inverter capacity or two or more motors are connected to one inverter, the energy saving effect is not expected.





#### NOTE

- When the optimum excitation control mode is selected, deceleration time may be longer than the setting value. Since overvoltage alarm tends to occur as compared to the constant torque load characteristics, set a longer deceleration time.
- Optimum excitation control functions only under V/F control. Optimum excitation control does not function under advanced magnetic flux vector control and general-purpose magnetic flux vector control.
- Optimum excitation control will not be performed during an automatic restart after instantaneous power failure.
- Since output voltage is controlled by optimum excitation control, output current may slightly increase.



#### Parameters referred to

Advanced magnetic flux vector control  Refer to page 79  
 General-purpose magnetic flux vector control  Refer to page 82  
*Pr. 57 Restart coasting time*  Refer to page 154

## 4.16 Motor noise, EMI measures, mechanical resonance

Purpose of Use	Parameter that should be Set		Refer to Page
Reduction of the motor noise Measures against EMI and leakage currents	Carrier frequency and Soft-PWM selection	Pr. 72, Pr. 240	166
Reduce mechanical resonance	Speed smoothing control	Pr. 653	167

### 4.16.1 PWM carrier frequency and soft-PWM control (Pr. 72, Pr. 240)

You can change the motor sound.

Parameter Number	Name	Initial Value	Setting Range	Description
72 *	PWM frequency selection	1	0 to 15	You can change the PWM carrier frequency. The setting is in [kHz]. Note that 0 indicates 0.7kHz and 15 indicates 14.5kHz.
240 *	Soft-PWM operation selection	1	0	Soft-PWM is invalid
			1	When Pr. 72 = "0 to 5", soft-PWM is valid.

The above parameters can be set when Pr.160 User group read selection = "0". (Refer to page 180)

\* The parameters in the table allow its setting to be changed during operation even if "0" (initial value) is set in Pr. 77 Parameter write selection.

#### (1) PWM carrier frequency changing (Pr. 72)

- You can change the PWM carrier frequency of the inverter.
- Changing the PWM carrier frequency produces an effect on avoiding the resonance frequency of a mechanical system or motor or on EMI measures or on leakage current reduction caused by the PWM switching.

#### (2) Soft-PWM control (Pr. 240)

- Soft-PWM control is a control method that changes the motor noise from a metallic tone into an unoffending complex tone.



#### NOTE

- Decreasing the PWM carrier frequency effect on EMI measures and on leakage current reduction, but increases motor noise.
- When PWM carrier frequency is set to 1kHz or less ( $Pr.72 \leq 1$ ), fast response current limit may function prior to stall prevention operation due to increase in ripple currents, resulting in insufficient torque. In such case, set fast-response current limit operation invalid using Pr. 156 Stall prevention operation selection .
- When setting 2kHz or more in Pr. 72 to perform operation in the place where the ambient temperature exceeding 40°C (104°F), caution should be taken as the rated inverter current should be reduced. (Refer to page 300)



#### Parameters referred to

Pr. 156 Stall prevention operation selection  Refer to page 85



### 4.16.2 Speed smoothing control (Pr. 653)

Vibration due to mechanical resonance influences the inverter control, causing the output current (torque) unstable. In this case, the output current (torque) fluctuation can be reduced to ease vibration by changing the output frequency.

Parameter Number	Name	Initial Value	Setting Range	Description
653	Speed smoothing control	0	0 to 200%	Increase or decrease the value using 100% as reference to check an effect.

#### (1) Control block diagram

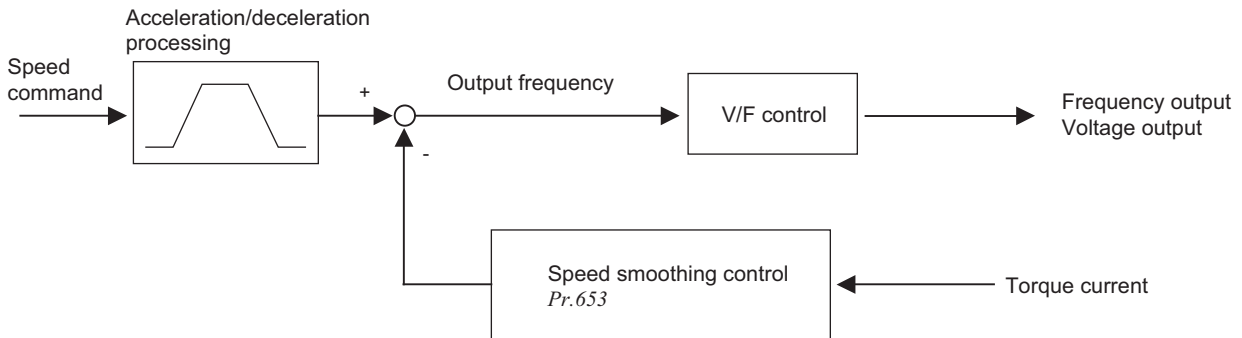

#### (2) Setting method

If vibration due to mechanical resonance occurs, set 100% in Pr. 653, run the inverter at the frequency which generates maximum vibration and check if the vibration will be reduced or not after several seconds.

If effect is not produced, gradually increase the Pr. 653 setting and check the effect repeatedly until the most effective value is set in Pr. 653.

If vibration becomes large by increasing the Pr. 653 setting, gradually decrease the Pr. 653 setting than 100% to check the effect in a similar manner.



#### NOTE



Depending on the machine, vibration may not be reduced enough or an effect may not be produced.

## 4.17 Frequency setting by analog input (terminal 2, 4)

Purpose	Parameter that should be Set		Refer to Page
Selection of voltage/current input (terminal 2, 4) Perform forward/reverse rotation by analog input.	Analog input selection	Pr. 73, Pr. 267	168
Adjustment (calibration) of analog input frequency and voltage (current)	Bias and gain of frequency setting voltage (current)	Pr. 125, Pr. 126, Pr. 241, C2 to C7 (Pr. 902 to Pr. 905)	171

### 4.17.1 Analog input selection (Pr. 73, Pr. 267)

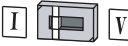
You can select the function that switches between forward rotation and reverse rotation according to the analog input terminal specifications and input signal.

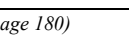
Parameter Number	Name	Initial Value	Setting Range	Description	
73	Analog input selection	1	0	Terminal 2 input 0 to 10V	Without reversible operation
			1	Terminal 2 input 0 to 5V	
			10	Terminal 2 input 0 to 10V	With reversible operation
			11	Terminal 2 input 0 to 5V	
267	Terminal 4 input selection	0	Voltage/current input switch		Description
			0		Terminal 4 input 4 to 20mA
			1		Terminal 4 input 0 to 5V
			2		Terminal 4 input 0 to 10V

The above parameters can be set when Pr. 160 User group read selection = "0". (Refer to page 180)

#### (1) Selection of analog input specifications

- For the terminal 2 for analog voltage input, 0 to 5V (initial value) or 0 to 10V can be selected.
- Either voltage input (0 to 5V, 0 to 10V) or current input (4 to 20mA initial value) can be selected for terminal 4 used for analog input.

Change the input specifications to change Pr. 267 and voltage/current input switch.

- Rated specifications of terminal 4 change according to the voltage/current input switch.

Voltage input: Input resistance  $10k\Omega \pm 1k\Omega$ ,  
Maximum permissible input voltage 20VDC  
Current input: Input resistance  $233\Omega \pm 5\Omega$ ,  
Maximum permissible input voltage 30mA

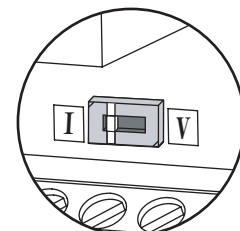

Current input (initial setting)

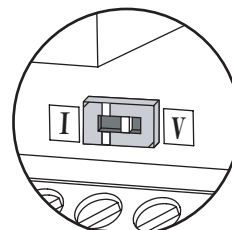

Voltage input

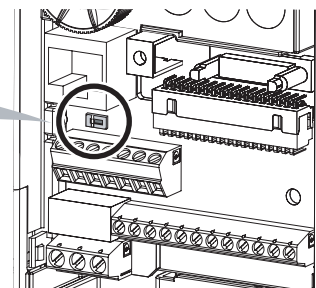

Control circuit terminal block



**NOTE**

- Set Pr. 267 and a voltage/current input switch correctly, then input an analog signal in accordance with the setting. Incorrect setting as in the table below could cause component damage. Incorrect settings other than below can cause abnormal operation.

Setting Causing Component Damage		Operation
Switch setting	Terminal input	
I (current input)	Voltage input	This could cause component damage to the analog signal output circuit of signal output devices. (electrical load in the analog signal output circuit of signal output devices increases)
V (voltage input)	Current input	This could cause component damage of the inverter signal input circuit. (output power in the analog signal output circuit of signal output devices increases)

Refer to the following table and set Pr. 73 and Pr. 267.

(  indicates main speed setting)

Pr. 73 Setting	Terminal 2 Input	Terminal 4 Input		Reversible Operation
		AU signal		
0	0 to 10V	OFF	—	Not function
1 (initial value)	0 to 5V			
10	0 to 10V			Yes
11	0 to 5V			
0	—	ON	According to the Pr. 267 setting 0:4 to 20mA (initial value) 1:0 to 5V 2:0 to 10V	Not function
1 (initial value)				
10				Yes
11				

- : invalid

- Turn the AU signal on to make terminal 4 valid.
- The terminal used for the AU signal input, set "4" in Pr. 178 to Pr. 184 (input terminal function selection) to assign functions.



**NOTE**

- Turn the AU signal on to make terminal 4 valid.
- Make sure that the parameter and switch settings are the same. Different setting may cause a fault, failure or malfunction.
- Use Pr. 125 (Pr. 126) (frequency setting gain) to change the maximum output frequency at input of the maximum output frequency command voltage (current). At this time, the command voltage (current) need not be input. Also, the acceleration/deceleration time, which is a slope up/down to the acceleration/deceleration reference frequency, is not affected by the change in Pr. 73 setting.
- Changing the terminal assignment using Pr. 178 to Pr. 184 (input terminal function selection) may affect the other functions. Make setting after confirming the function of each terminal.

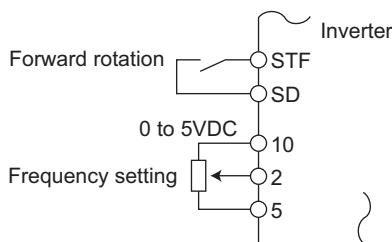

Connection diagram using terminal 2 (0 to 5VDC)

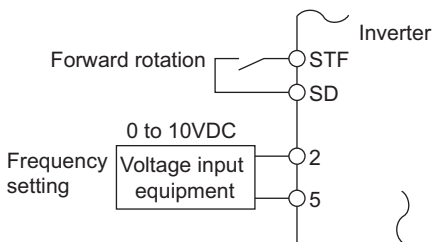

Connection diagram using terminal 2 (0 to 10VDC)

(2) Perform operation by analog input selection.

- The frequency setting signal inputs 0 to 5VDC (or 0 to 10VDC) to across the terminals 2-5. The 5V (10V) input is the maximum output.
- The power supply 5V can be input by either using the internal power supply or preparing an external power supply. Prepare an external power supply to input the power supply 10V. For the built-in power supply, terminals 10-5 provide 5VDC output.

Terminal	Inverter Built-in Power Supply Voltage	Frequency Setting Resolution	Pr. 73 (terminal 2 input power)
10	5VDC	0.030Hz/60Hz	0 to 5VDC input

- When inputting 10VDC to the terminal 2, set "0" or "10" in Pr. 73. (The initial value is 0 to 5V)
- Setting "1 (0 to 5VDC)" or "2 (0 to 10VDC)" in Pr. 267 and a voltage/current input switch in the OFF position changes the terminal 4 to the voltage input specification. When the AU signal turns on, the terminal 4 input becomes valid.



**REMARKS**

The wiring length of the terminal 10, 2, 5 should be 30m (98.42feet) maximum.

## 7 Frequency setting by analog input (terminal 2, 4)

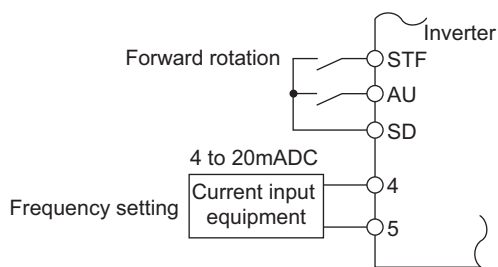

Connection diagram using terminal 4 (4 to 20mADC)

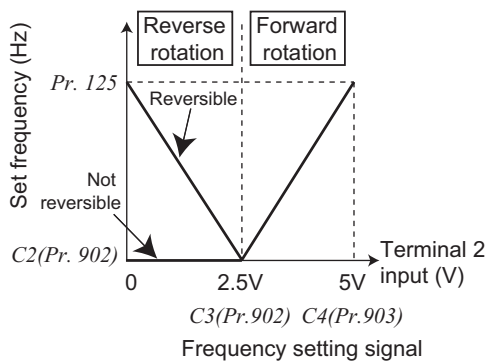

Reversible operation example

### (3) Perform operation by analog input selection.

- When the pressure or temperature is controlled constant by a fan, pump, etc., automatic operation can be performed by inputting the output signal 4 to 20mADC of the adjuster to across the terminals 4-5.
- The AU signal must be turned on to use the terminal 4.

### (4) Perform forward/reverse rotation by analog input (polarity reversible operation)

- Setting "10" or "11" in Pr. 73 and adjusting Pr. 125 (Pr. 126) Terminal 2 frequency setting gain frequency (Terminal 4 frequency setting gain frequency) and C2 (Pr. 902) Terminal 2 frequency setting bias frequency to C7 (Pr.905) Terminal 4 frequency setting gain makes reverse operation by terminal 2 (terminal 4) valid.

Example) When performing reversible operation by terminal 2 (0 to 5V) input

- 1) Set "11" in Pr. 73 to make reversible operation valid.  
Set frequency at maximum analog input in Pr. 125 (Pr. 903)
- 2) Set 1/2 of the value set in C4 (Pr. 903) in C3 (Pr. 902).
- 3) Reversible operation is performed when 0 to 2.5VDC is input and forward rotation when 2.5 to 5VDC.



### NOTE

- When reversible operation is set, be aware of reverse rotation operation when analog input stops (only the start signal is input).
- When reversible operation is valid, reversible operation (0 to 4mA: reverse operation, 4mA to 20mA: forward operation) is performed by terminal 4 in the initial setting.



### Parameters referred to

Pr. 125 Terminal 2 frequency setting gain frequency, Pr. 126 Terminal 4 frequency setting gain frequency Refer to page 171  
C2 (Pr. 902) Terminal 2 frequency setting bias frequency to C7 (Pr. 905) Terminal 4 frequency setting gain Refer to page 171

## 4.17.2 Response level of analog input and noise elimination (Pr. 74)

The time constant of the primary delay filter can be set for the external frequency command (analog input (terminal 2, 4) signal).

Parameter Number	Name	Initial Value	Setting Range	Description
74	Input filter time constant	1	0 to 8	Primary delay filter time constant for the analog input. A larger setting results in a larger filter.

The above parameters can be set when Pr. 160 User group read selection = "0". (Refer to page 180)

- Valid for eliminating noise of the frequency setting circuit.
- Increase the filter time constant if steady operation cannot be performed due to noise.  
A larger setting results in slower response. (The time constant can be set between approximately 1ms to 1s with the setting of 0 to 8.)

**4.17.3 Bias and gain of frequency setting voltage (current)  
(Pr. 125, Pr. 126, Pr. 241, C2 (Pr. 902) to C7 (Pr. 905))**

You can set the magnitude (slope) of the output frequency as desired in relation to the frequency setting signal (0 to 5V, 0 to 10V or 4 to 20mADC).

Set Pr. 267 and voltage/current input switch to switch between 0 to 5VDC, 0 to 10VDC, 0 to 20mADC using terminal 4.  
(Refer to page 168)

[Frequency setting bias/gain parameter]

Parameter Number	Name	Initial Value	Setting Range	Description
<b>125</b>	<b>Terminal 2 frequency setting gain frequency</b>	60Hz	0 to 400Hz	Frequency of terminal 2 input gain (maximum).
<b>126</b>	<b>Terminal 4 frequency setting gain frequency</b>	60Hz	0 to 400Hz	Frequency of terminal 4 input gain (maximum).
<b>241</b> *1, *3	<b>Analog input display unit switchover</b>	0	0	Displayed in %
			1	Displayed in V/mA
<b>C2 (902)</b> *1, *2	<b>Terminal 2 frequency setting bias frequency</b>	0Hz	0 to 400Hz	Frequency on the bias side of terminal 2 input.
<b>C3 (902)</b> *1, *2	<b>Terminal 2 frequency setting bias</b>	0%	0 to 300%	Converted % of the bias side voltage (current) of terminal 2 input.
<b>C4 (903)</b> *1, *2	<b>Terminal 2 frequency setting gain</b>	100%	0 to 300%	Converted % of the gain side voltage of terminal 2 input.
<b>C5 (904)</b> *1, *2	<b>Terminal 4 frequency setting bias frequency</b>	0Hz	0 to 400Hz	Frequency on the bias side of terminal 4 input.
<b>C6 (904)</b> *1, *2	<b>Terminal 4 frequency setting bias</b>	20%	0 to 300%	Converted % of the bias side current (voltage) of terminal 4 input.
<b>C7 (905)</b> *1, *2	<b>Terminal 4 frequency setting gain</b>	100%	0 to 300%	Converted % of the gain side current (voltage) of terminal 4 input.

\*1 The above parameters can be set when Pr. 160 User group read selection = "0". (Refer to page 180)

\*2 The parameter number in parentheses is the one for use with the operation panel (PA02) for the FR-E500 series or parameter unit (FR-PU04/FR-PU07).

\*3 The above parameters allow its setting to be changed during operation in any operation mode even if "0" (initial value) is set in Pr. 77 Parameter write selection.

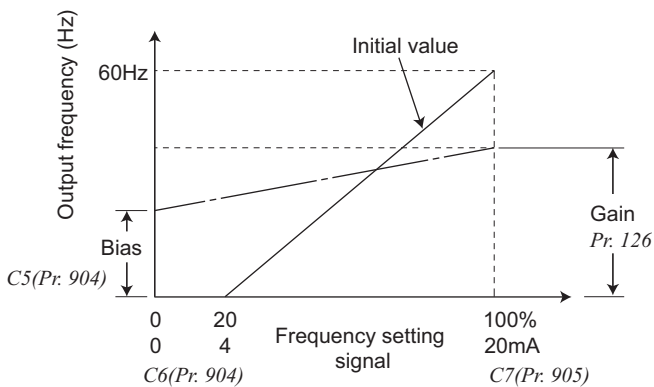
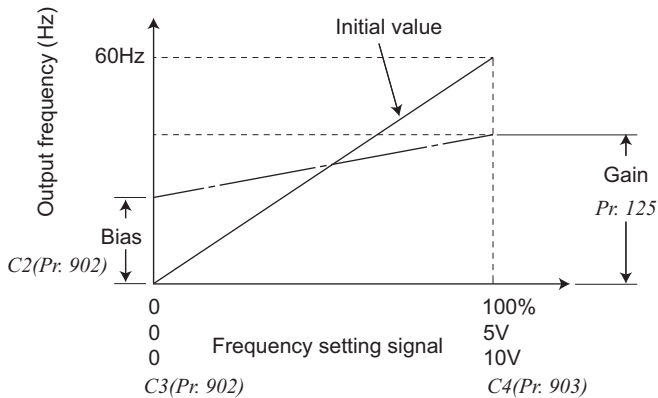

### (1) Change the frequency at maximum analog input (Pr. 125, Pr. 126)

- Set Pr. 125 (Pr. 126) when changing frequency setting (gain) of the maximum analog input voltage (current) only. (C2 (Pr. 902) to C7 (Pr.905) setting need not be changed)

### (2) Analog input bias/gain calibration (C2 (Pr. 902) to C7 (Pr. 905))

- The "bias" and "gain" functions are used to adjust the relationship between the input signal entered from outside the inverter to set the output frequency, e.g. 0 to 5V, 0 to 10V or 4 to 20mADC, and the output frequency.
- Set the bias frequency of the terminal 2 input using C2 (Pr. 902).  
(It is initially-set to the frequency at 0V)
- Set the output frequency in Pr. 125 for the frequency command voltage set with Pr. 73 Analog input selection.
- Set the bias frequency of the terminal 4 input using C5 (Pr. 904).  
(It is initially-set to the frequency at 4mA)
- Using Pr. 126, set the output frequency relative to 20mA of the frequency command current (4 to 20mA).
- There are three methods to adjust the frequency setting voltage (current) bias/gain.
  - a) Method to adjust any point without application of a voltage (current) to across terminals 2-5 (4-5)  
☞ page 173
  - b) Method to adjust any point without application of a voltage (current) to across terminals 2-5 (4-5)  
☞ page 174
  - c) Method to adjust torque only without adjustment of voltage (current) ☞ page 175



#### NOTE

- When voltage/current input signal for terminal 4 was switched using Pr. 267 and voltage/current input switch, perform calibration without fail.

### (3) Analog input display unit changing (Pr. 241)

- You can change the analog input display unit (%V/mA) for analog input bias/gain calibration.
- Depending on the terminal input specification set to Pr. 73, Pr. 267, and voltage/current switch, the display units of C3 (Pr. 902), C4 (Pr. 903), C6 (Pr. 904), C7 (Pr. 905) change as shown below.

Analog Command (terminal 2, 4) (depending on Pr. 73, Pr. 267, and voltage/current input switch)	Pr. 241 = 0 (initial value)	Pr. 241 = 1
0 to 5V input	0 to 5V → 0 to 100% (0.1%) display	0 to 100% → 0 to 5V (0.01V) display
0 to 10V input	0 to 10V → 0 to 100% (0.1%) display	0 to 100% → 0 to 10V (0.01V) display
0 to 20mA input	0 to 20mA → 0 to 100% (0.1%) display	0 to 100% → 0 to 20mA (0.01mA) display

**(4) Frequency setting signal (current) bias/gain adjustment method**

(a) Method to adjust any point without application of a voltage (current) to across terminals 2-5 (4-5).

**Operation**

**Display**

1. Confirmation of the RUN indication and operation mode indication

- The inverter should be at a stop.
- The inverter should be in the PU operation mode.

(Using )





2. Press  to choose the parameter setting mode.

PRM indication is lit.





→  (The parameter number read previously appears.)

3. Turn  until  appears.





→ 

4. Turn  until  appears.



→  (C0 to C41 setting) is enabled.

5. Turn  until  appears.  
Set to C4 Terminal 2 frequency setting gain.



→  Terminal 2 input is selected



Terminal 4 input is selected  
Analog voltage (current) value (%) across terminals 2-5 (across terminals 4-5)

6. Press  to display the analog voltage (current) value (%).



→ 

7. Apply a 5V (20mA) voltage (current).  
(Turn the external potentiometer connected across terminals 2-5 (across terminals 4-5) to maximum (any position).)



→  \*

\* The value is nearly 100 (%) in the maximum position of the potentiometer.





**NOTE**

After performing operation in step 6, do not touch  until completion of calibration.





8. Press  to set.



→  \* Terminal 2 input is selected  
 Terminal 4 input is selected  

**Flicker...Parameter setting complete!!**

\* The value is nearly 100 (%) in the maximum position of the potentiometer.

- Turn  to read another parameter.
- Press  to return to the  indication (step 4).
- Press  twice to show the next parameter ().



**REMARKS**

- If the frequency meter (display meter) connected across the terminals AM-5 does not indicate just 60Hz, set the *calibration parameter C1 AM terminal calibration*. (Refer to page 152)

## 7 Frequency setting by analog input (terminal 2, 4)

- (b) Method to adjust any point without application of a voltage (current) to across terminals 2-5 (4-5)  
(To change from 4V (80%) to 5V (100%))

### Operation

1. Confirmation of the RUN indication and operation mode indication

- The inverter should be at a stop.
- The inverter should be in the PU operation mode.

(Use )

2. Press  to choose the parameter setting mode.

3. Turn  until  $\lfloor \dots \rfloor$  appears.

4. Turn  until  $\lfloor - - - \rfloor$  appears.

5. Turn  until  $\lfloor 4 \rfloor$  ( $\lfloor 7 \rfloor$ ) appears.  
Set to C4 Terminal 2 frequency setting gain.

6. Press  to display the analog voltage (current) value (%).

7. Turn  to set gain voltage (%).  
"0V(0mA) is 0%, 10V(5V, 20mA) is 100%"

8. Press  to set.

### Display



PRM indication is lit.

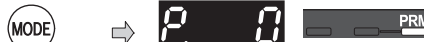

(The parameter number read previously appears.)

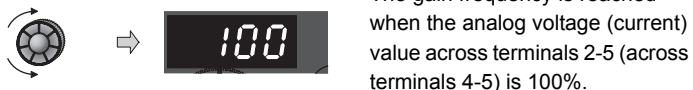
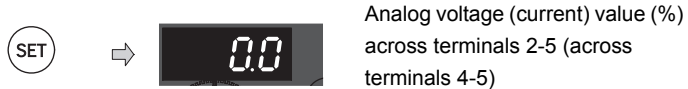

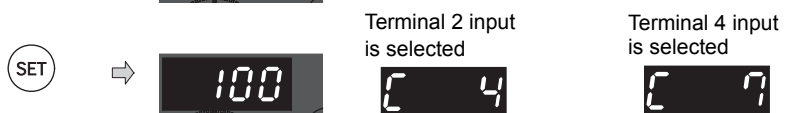

### REMARKS

The current setting at the instant of turning  is displayed.  
You can not check after performing operation in step 7.



**Flicker...Parameter setting complete!!**  
(Adjustment completed)



















- Turn  to read another parameter.
- Press  to return to the  $\lfloor - - - \rfloor$  indication (step 4).
- Press  twice to show the next parameter ( $P_r.\lfloor \lfloor \rfloor$ ).

### REMARKS

By pressing  after step 6, you can confirm the current frequency setting bias/gain setting.  
You can not check after performing operation in step 7.



- (c) Adjusting only the frequency without adjusting the gain voltage (current).  
(When changing the gain frequency from 60Hz to 50Hz)

Operation	Display
1. Turn  until P. 125 (Pr. 125) or P. 126 (Pr. 126) appears	 →  Terminal 2 input is selected or  Terminal 4 input is selected
2. Press  to show the currently set value. (60.00Hz)	 → 
3. Turn  to change the set value to "50.00". (50.00Hz)	 → 
4. Press  to set.	 →  Terminal 2 input is selected  Terminal 4 input is selected 
<b>Flicker...Parameter setting complete!!</b>	
5. Mode/monitor check Press  twice to choose the monitor/frequency monitor.	 → 
6. Apply a voltage across the inverter terminals 2-5 (across 4-5) and turn on the start command (STF, STR). Operation starts at 50Hz.	





 **REMARKS**

- Changing C4 (Pr. 903) or C7 (Pr. 905) (gain adjustment) value will not change the Pr. 20 value.
- For operation from the parameter unit (FR-PU04/FR-PU07), refer to the instruction manual of the FR-PU04/FR-PU07.
- When setting the value to 120Hz or more, it is necessary to set Pr. 18 High speed maximum frequency to 120Hz or more. (Refer to page 89)
- Make the bias frequency setting using the calibration parameter C2 (Pr. 902) or C5 (Pr. 904). (Refer to page 172)
- Refer to page 262 to use the FR-E500 series operation panel (PA02).

 **CAUTION**

 Take care when setting any value other than "0" as the bias frequency at 0V (0mA). Even if a speed command is not given, merely turning on the start signal will start the motor at the preset frequency.

 **Parameters referred to**

- Pr. 20 Acceleration/deceleration reference frequency  Refer to page 102
- Pr. 73 Analog input selection, Pr. 267 Terminal 4 input selection  Refer to page 168
- Pr. 79 Operation mode selection  Refer to page 183
- Bias and gain of built-in frequency setting potentiometer  Refer to page 262

## 4.18 Misoperation prevention and parameter setting restriction

Purpose	Parameter that should be Set		Refer to Page
Limits reset function Trips stop when PU is disconnected Stops from PU	Reset selection/disconnected PU detection/PU stop selection	Pr. 75	176
Prevention of parameter rewrite	Parameter write disable selection	Pr. 77	179
Prevention of reverse rotation of the motor	Reverse rotation prevention selection	Pr. 78	180
Displays necessary parameters	Display of applied parameters and user group function	Pr. 160, Pr. 172 to Pr. 174	180
Control of parameter write by communication	EEPROM write selection	Pr. 342	207



### 4.18.1 Reset selection/disconnected PU detection/PU stop selection (Pr. 75)

You can select the reset input acceptance, disconnected PU (FR-PU04/FR-PU07) connector detection function and PU stop function.

Parameter Number	Name	Initial Value	Setting Range	Description
75	Reset selection/ disconnected PU detection/ PU stop selection	14	0 to 3, 14 to 17	For the initial value, reset always enabled, without disconnected PU detection, and with PU stop function are set.

•The above parameters can be set when Pr. 160 User group read selection = "0". (Refer to page 180)

•The Pr. 75 value can be set any time. Also, if parameter (all) clear is executed, this setting will not return to the initial value.

Pr. 75 Setting	Reset Selection	Disconnected PU Detection	PU Stop Selection
0	Reset input normally enabled	If the PU is disconnected, operation will be continued.	Pressing  decelerates the motor to a stop only in the PU operation mode.
1	Reset input is enabled only when the fault occurs.		
2	Reset input normally enabled	When the PU is disconnected, the inverter trips.	
3	Reset input is enabled only when the fault occurs.		
14 (initial value)	Reset input normally enabled	If the PU is disconnected, operation will be continued.	Pressing  decelerates the motor to a stop in any of the PU, external and communication operation modes.
15	Reset input is enabled only when the fault occurs.		
16	Reset input normally enabled	When the PU is disconnected, the inverter trips.	
17	Reset input is enabled only when the fault occurs.		

#### (1) Reset selection

- You can select the enable condition of reset function (RES signal, reset command through communication) input.
- When Pr. 75 is set to any of "1, 3, 15, 17", a reset can be input only when the inverter is tripped.



#### NOTE

- When the reset signal (RES) is input during operation, the motor coasts since the inverter being reset shuts off the output.
- When reset is performed, cumulative values of electronic thermal O/L relay, regenerative brake duty are cleared.
- The reset key of the PU is only valid when the inverter is tripped, independently of the Pr. 75 setting.

#### (2) Disconnected PU detection

- This function detects that the PU (FR-PU04/FR-PU07) has been disconnected from the inverter for longer than 1s and causes the inverter to provide a fault output (E.PUE) and come to trip.
- When Pr. 75 is set to any of "0, 1, 14, 15", operation is continued if the PU is disconnected.



#### REMARKS

- When the PU has been disconnected since before power-on, it is not judged as a fault.
- To make a restart, confirm that the PU is connected and then reset the inverter.
- The motor decelerates to a stop when the PU is disconnected during PU jog operation with Pr. 75 set to any of "0, 1, 14, 15" (which selects operation is continued if the PU is disconnected).
- When RS-485 communication operation is performed through the PU connector, the reset selection/PU stop selection function is valid but the disconnected PU detection function is invalid.

**(3) PU stop selection**

- In any of the PU operation, external operation and network operation modes, the motor can be stopped by pressing STOP key of the operation panel or parameter unit (FR-PU04/FR-PU07, operation panel for FR-E500 (PA02)).
- When the inverter is stopped by the PU stop function, "PS" (PS) is displayed. A fault output is not provided.
- After the motor is stopped from the PU, it is necessary to perform PU stop (PS) reset to restart. PS reset can be made from the unit from which PU stop is made (operation panel, parameter unit (FR-PU04/PU07, operation panel for FR-E500 (PA02))).
- The motor can be restarted by making PS cancel using a power supply reset or RES signal.
- When Pr. 75 is set to any of "0 to 3", PU stop (PS display) is invalid, deceleration to a stop by  is valid only in the PU operation mode.



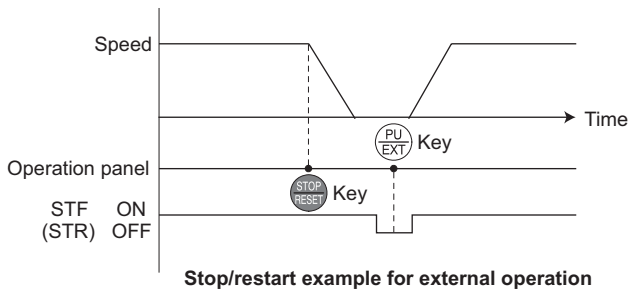

 **REMARKS**

During operation in the PU operation mode through USB communication or RS-485 communication from the PU connector, the motor decelerates to stop (PU stop) from the operation panel when entered from the operation panel .

**(4) How to restart the motor stopped by  input from the PU in external operation mode (PU stop (PS) reset method)**



**a) Operation panel**

- 1) After completion of deceleration to a stop, switch off the STF or STR signal.
- 2) Press  to display  ..... (PS reset)
- 3) Press  to return to .
- 4) Switch on the STF or STR signal.

**b) Parameter unit (FR-PU04/FR-PU07)**

- 1) After completion of deceleration to a stop, switch off the STF or STR signal.
- 2) Press  ..... (PS reset)
- 3) Switch on the STF or STR signal.

- The motor can be restarted by making a reset using a power supply reset or RES signal.







 **REMARKS**

- If Pr. 250 Stop selection is set to other than "9999" to select coasting to a stop, the motor will not be coasted to a stop but decelerated to a stop by the PU stop function during external operation.

### (5) Restart (PS reset) method when PU stop (PS display) is made during PU operation

- PU stop (PS display) is made when the motor is stopped from the unit where control command source is not selected (operation panel, parameter unit (FR-PU04/FR-PU07, operation panel for FR-E500 (PA02)) in the PU operation mode. For example, when *Pr. 551 PU mode operation command source selection* = "9999" (initial value), the motor is stopped from the PU (PS display) if entered from the operation panel  in PU operation mode with the parameter unit mounted.

#### When the motor is stopped from the PU when the parameter unit (FR-PU04/FR-PU07) is selected as control command source.

- 1) After the motor has decelerated to a stop, press  of the parameter unit (FR-PU04/FR-PU07).
- 2) Press  to display . ( *PS* reset )
- 3) Press  of the parameter unit (FR-PU04/FR-PU07) to select the PU operation mode.
- 4) Press  or  of the parameter unit (FR-PU04/FR-PU07).



#### REMARKS

- When *Pr. 551* = "9999", the priorities of the PU control source is USB connector > parameter unit (FR-PU04/FR-PU07) > operation panel.



## CAUTION





Do not reset the inverter while the start signal is being input.

Otherwise, the motor will start instantly after resetting, leading to potentially hazardous conditions.



#### Parameters referred to

*Pr. 250 Stop selection*  Refer to page 124

*Pr. 551 PU mode operation command source selection*  Refer to page 194

### 4.18.2 Parameter write disable selection (Pr. 77)

You can select whether write to various parameters can be performed or not. Use this function to prevent parameter values from being rewritten by misoperation.

Parameter Number	Name	Initial Value	Setting Range	Description
77	Parameter write selection	0	0	Write is enabled only during a stop.
			1	Parameter can not be written.
			2	Parameter write is enabled in any operation mode regardless of operation status.

The above parameters can be set when Pr. 160 User group read selection = "0". (Refer to page 180)

Pr. 77 can be always set independently of the operation mode and operation status.

#### (1) Write parameters only during stop (setting "0" initial value)

- Parameters can be written only during a stop in the PU operation mode.
- The shaded parameters in the parameter list (page 54) can always be written regardless of the operation mode and operating status. However, Pr. 72 PWM frequency selection and Pr. 240 Soft-PWM operation selection can be written when the inverter is running in the PU operation mode, but cannot be written in the external operation mode.

#### (2) Inhibit parameter write (setting "1")

- Parameter write is not enabled.  
(Read is enabled.)
- Parameter clear and all parameter clear cannot be performed, either.
- The parameters given on the right can be written if Pr. 77 = "1".

Parameter Number	Name
22	Stall prevention operation level
75	Reset selection/disconnected PU detection/PU stop selection
77	Parameter write selection
79	Operation mode selection
160	User group read selection

#### (3) Write parameters during operation (setting "2")

- Parameters can always be written.
- The following parameters cannot be written when the inverter is running if Pr. 77 = "2". Stop the inverter when changing their parameter settings.

Parameter Number	Name
19	Base frequency voltage
23	Stall prevention operation level compensation factor at double speed
40	RUN key rotation direction selection
48	Second stall prevention operation current
60	Energy saving control selection
61	Reference current
66	Stall prevention operation reduction starting frequency
71	Applied motor
79	Operation mode selection
80	Motor capacity
81	Number of motor poles
82	Motor excitation current
83	Motor rated voltage
84	Rated motor frequency
90 to 94	(Motor constants)
96	Auto tuning setting/status
178 to 184	(input terminal function selection)
190 to 192	(output terminal function selection)

Parameter Number	Name
255	Life alarm status display
256	Inrush current limit circuit life display
257	Control circuit capacitor life display
258	Main circuit capacitor life display
277	Stall prevention operation current switchover
292	Automatic acceleration/deceleration
293	Acceleration/deceleration individual operation selection
298	Frequency search gain
329	Digital input unit selection (Parameter for the plug-in option FR-A7AX E kit)
343	Communication error count
450	Second applied motor
541	Frequency command sign selection (CC-Link) (Parameter for the plug-in option FR-A7NC E kit)
563	Energization time carrying-over times
564	Operating time carrying-over times
800	Control method selection
859	Torque current



#### Parameters referred to

Pr. 79 Operation mode selection Refer to page 183

## 4.18.3 Reverse rotation prevention selection (Pr. 78)

This function can prevent reverse rotation fault resulting from the incorrect input of the start signal.

Parameter Number	Name	Initial Value	Setting Range	Description
78	Reverse rotation prevention selection	0	0	Both forward and reverse rotations allowed
			1	Reverse rotation disabled
			2	Forward rotation disabled

The above parameters can be set when Pr. 160 User group read selection = "0". (Refer to page 180)

- Set this parameter when you want to limit the motor rotation to only one direction.
- This parameter is valid for all of the reverse rotation and forward rotation keys of the operation panel and parameter unit (FR-PU04/FR-PU07), the start signals (STF, STR signals) via external terminals, and the forward and reverse rotation commands through communication.

## 4.18.4 Extended parameter display and user group function (Pr. 160, Pr. 172 to Pr. 174)

Parameter which can be read from the operation panel and parameter unit can be restricted.

Parameter Number	Name	Initial Value	Setting Range	Description
160	User group read selection	0	9999	Displays only the simple mode parameters
			0	Displays simple mode + extended parameters
			1	Displays the parameters registered in the user group.
172 *1	User group registered display/batch clear	0	(0 to 16)	Displays the number of cases registered as a user group (reading only)
			9999	Batch clear the user group registration
173 *1, *2	User group registration	9999	0 to 999, 9999	Sets the parameter numbers to be registered to the user group
174 *1, *2	User group clear	9999	0 to 999, 9999	Sets the parameter numbers to be cleared from the user group

\*1 The above parameters can be set when Pr. 160 User group read selection = "0".

\*2 The values read from Pr. 173 and Pr. 174 are always "9999".

### (1) Display of simple mode parameters and extended parameters (Pr. 160)

- When Pr. 160 = "9999", only the simple mode parameters can be displayed on the operation panel and parameter unit (FR-PU04/FR-PU07). (Refer to the parameter list, page 54, for the simple mode parameters.)
- In the initial setting (Pr. 160 = "0") status, simple mode parameters and extended parameters can be displayed.

### REMARKS

- When a plug-in option is fitted to the inverter, the option parameters can also be read.
- When communication is used to read the parameters, all parameters can be read, regardless of the Pr. 160 setting.
- When RS-485 communication is used to read the parameters, all parameters can be read, regardless of the Pr. 550 NET mode operation command source selection, Pr. 551 PU mode operation command source selection, regardless of Pr. 160 setting.

Pr. 551	Pr. 550	Pr. 160 Valid/Invalid
2 (PU)	-	Valid
3 (USB) 9999 (auto detect initial value)	0 (OP)	Valid
	2 (PU)	Invalid (all parameters can be read)
	9999 (auto detect initial value)	With OP: valid Without OP: invalid (all parameters can be read)

\* OP indicates a communication option.

- Pr. 15 JOG frequency, Pr. 16 JOG acceleration/deceleration time, and Pr. 991 PU contrast adjustment are displayed as simple mode parameter when the parameter unit (FR-PU04/FR-PU07) is fitted.

**(2) User group function (Pr. 160, Pr. 172 to Pr. 174)**







- The user group function is designed to display only the parameters necessary for setting.
- From among all parameters, 16 parameters maximum can be registered in the user group. When Pr. 160 is set to "1", only the parameters registered to the user group can be accessed. (The parameters not registered in the user group can not be read.)
- To set a parameter in the user group, set its parameter number in Pr. 173.
- To delete a parameter from the user group, set its parameter number to Pr. 174. Set "9999" in Pr. 172 to batch delete parameters registered.

**(3) Registration of parameter to user group (Pr. 173)**

When registering Pr. 3 to user group

Operation

1. Confirm the operation display and operation mode display.
  - The inverter should be at a stop.
  - Make sure that the inverter is in PU operation mode.

(Press  in the external operation mode.)
2. Turn  until P. 16 1 appears.
3. Turn  to change the set value to "P. 173".
4. Press  to display 9999 .
5. Turn  until Pr. 3 appears.
6. Press  to set.  
 "P. 173" and "3 " are displayed alternately.  
 To continue parameter registration, repeat steps 3 to 6.

Display

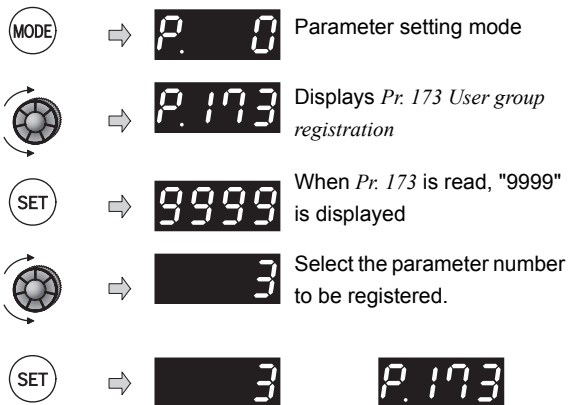







Flicker...Registration of Pr. 3 to user group completed!!

## (4) Deletion of parameter from user group (Pr. 174)

When deleting Pr. 3 from user group

### Operation

1. Confirm the operation display and operation mode display.
  - The inverter should be at a stop.
  - The inverter should be in the PU operation mode.

(Press  in the external operation mode.)
2. Press  to choose the parameter setting mode.
3. Turn  until P. 174 appears.
4. Press  to display "9999".
5. Turn  until Pr. 3 appears.
6. Press  to set.  
 "P. 174" and "3" are displayed alternately.  
 To continue parameter clear, repeat steps 3 to 6.

### Display

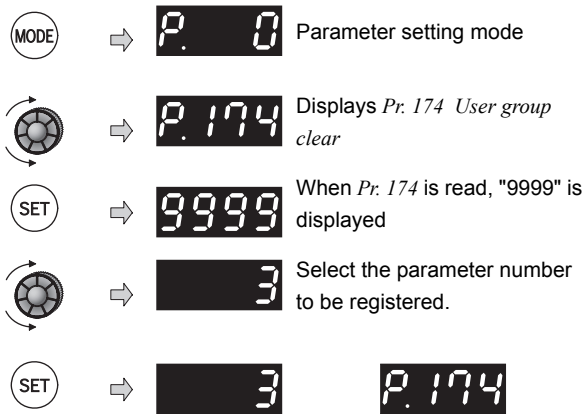



**Flicker...Clear of Pr. 3 to user group completed!!**

### REMARKS

- Pr. 77, Pr. 160 and Pr. 991 can always be read, independently of the user group setting.
- Pr. 77, Pr. 160 and Pr. 172 to Pr. 174 cannot be registered to the user group.
- When Pr. 174 is read, "9999" is always displayed. Although "9999" can be written, no function is available.
- When any value other than "9999" is set to Pr. 172, no function is available.



### Parameters referred to

- Pr. 550 NET mode operation command source selection  Refer to page 194
- Pr. 551 PU mode operation command source selection  Refer to page 194



## 4.19 Selection of operation mode and operation location

Purpose	Parameter that should be Set		Refer to Page
Operation mode selection	Operation mode selection	Pr. 79	183
Started in network operation mode	Operation mode at power-on	Pr. 79, Pr. 340	193
Selection of operation location	Operation command source and speed command source during communication operation, selection of operation location	Pr. 338, Pr. 339 Pr. 550, Pr. 551	194

### 4.19.1 Operation mode selection (Pr. 79)

Used to select the operation mode of the inverter.

Mode can be changed as desired between operation using external command signals (external operation), operation from the operation panel and PU (FR-PU07/FR-PU04) (PU operation), combined operation of PU operation and external operation (external/PU combined operation), and network operation (when RS-485 communication or a communication option is used).

Parameter Number	Name	Initial Value	Setting Range	Description	LED Indication		
					<input type="checkbox"/> :Off <input type="checkbox"/> :On		
79	Operation mode selection	0	0	Use external/PU switchover mode (  ) to switch between the PU and external operation mode. At power on, the inverter is in the external operation mode.	External operation mode  PU operation mode 		
			1	Fixed to PU operation mode			
			2	Fixed to external operation mode Operation can be performed by switching between the external and Net operation mode.	External operation mode  NET operation mode 		
			3	External/PU combined operation mode 1		External signal input (terminal STF, STR)	
				<b>Frequency command</b> Operation panel and PU (FR-PU04/FR-PU07) setting or external signal input (multi-speed setting, across terminals 4-5 (valid when AU signal turns on)).	<b>Start command</b>		
			4	External/PU combined operation mode 2		Enter from  of the operation panel and  and  of the PU (FR-PU04/FR-PU07)	
				<b>Frequency command</b> External signal input (terminal 2, 4, JOG, multi-speed selection, etc.)	<b>Start command</b>		
			6	Switchover mode Switchover between PU operation, external operation, and NET operation is available while keeping the same operation status.	PU operation mode  External operation mode  NET operation mode 		
7	External operation mode (PU operation interlock) X12 signal ON Operation mode can be switched to the PU operation mode. (output stop during external operation) X12 signal OFF Operation mode can not be switched to the PU operation mode.	PU operation mode  External operation mode 					

The above parameters can be changed during a stop in any operation mode.

### (1) Operation mode basics

- The operation mode specifies the source of the start command and the frequency command for the inverter.
- Select the "external operation mode" when the start command and the frequency command are applied from a potentiometer, switches, etc. which are provided externally and connecting them to the control terminals. Select "PU operation mode" when the commands are applied using the operation panel or parameter unit (FR-PU04/FR-PU07). Select the "network operation mode (NET operation mode)" when the commands are applied from the RS-485 communication with the PU connector or the network to the communication option card.
- The operation mode can be selected from the operation panel or with the communication instruction code.

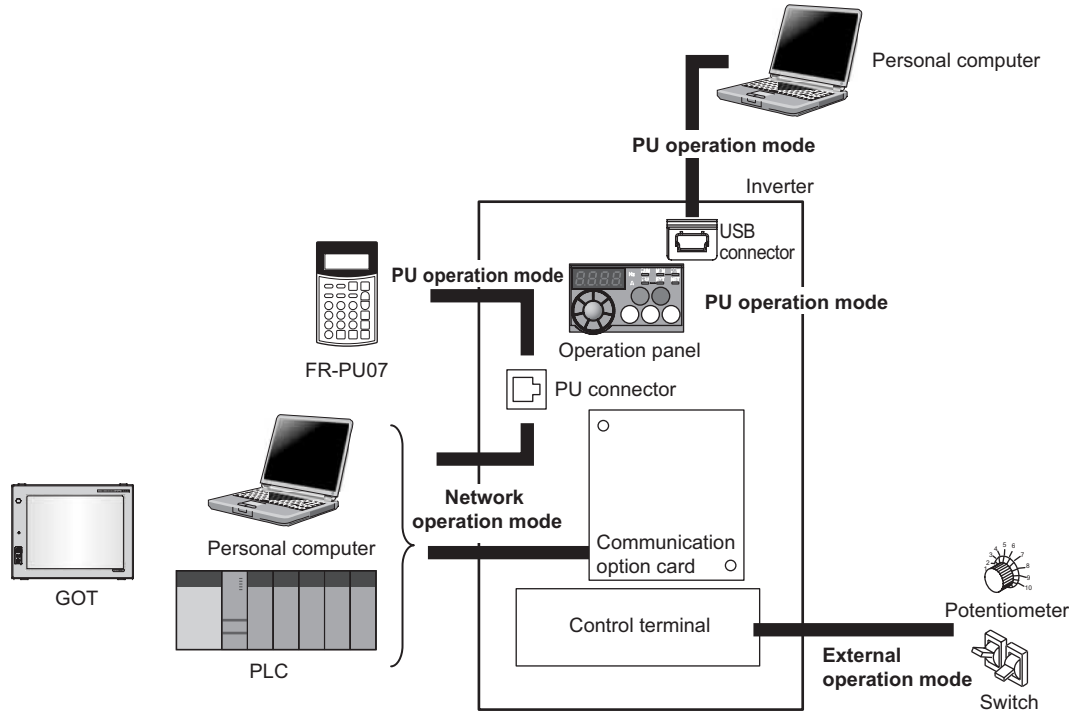

### REMARKS

- Either "3" or "4" may be set to select the PU/external combined mode. Refer to page 183 for details.
- The stop function (PU stop selection) activated by pressing  of the operation panel and parameter unit (FR-PU04/FR-PU07) is valid even in other than the PU operation mode in the initial setting. (Refer to Pr. 75 Reset selection/disconnected PU detection/PU stop selection (page 176))

(2) Operation mode switching method

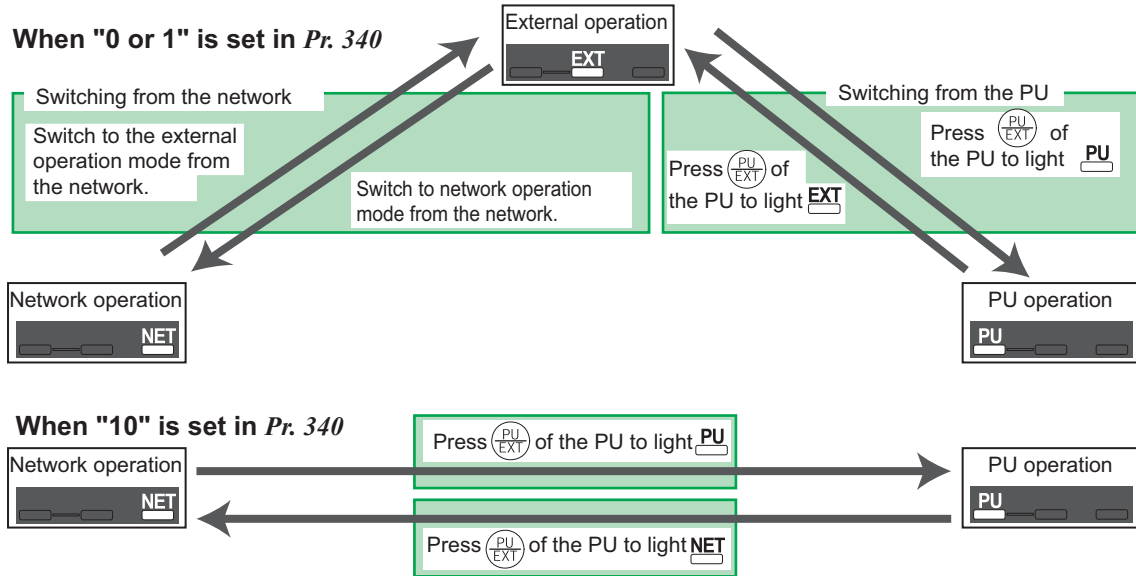

**REMARKS**

- Refer to the flow chart on the next page for switching by the external terminal.
- PU operation external interlock signal (X12) Refer to page 189
- PU-external operation switch-over signal (X16) Refer to page 190
- External-NET operation switchover signal (X65), NET-PU operation switchover signal (X66) Refer to page 191
- Pr. 340 Communication startup mode selection Refer to page 193

# 7 Selection of operation mode and operation location

## (3) Operation mode selection flow

In the following flowchart, select the basic parameter setting and terminal connection related to the operation mode.

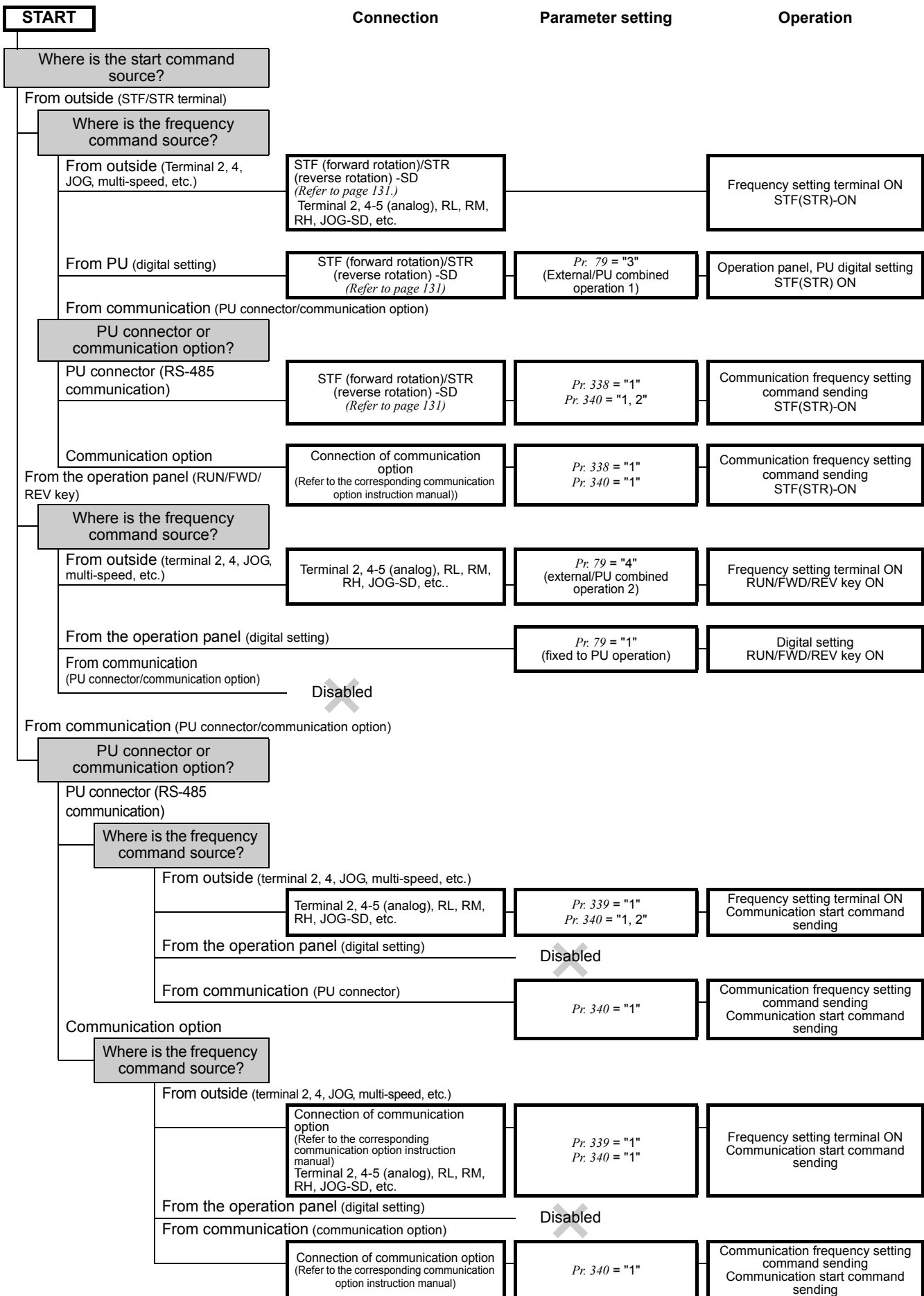

**(4) External operation mode (setting "0" (initial value), "2")**

- Select the external operation mode when the start command and the frequency command are applied from a frequency setting potentiometer, start switch, etc. which are provided externally and connecting them to the control circuit terminals of the inverter.
  - Basically, parameter changing is disabled in the external operation mode. (Some parameters can be changed. Refer to *page 54* for the parameter list.)
  - When "0" or "2" is selected for *Pr. 79*, the inverter enters the external operation mode at power-on. (When using the network operation mode, refer to *page 193*.)
  - When parameter changing is seldom necessary, setting "2" fixes the operation mode to the external operation mode.
- When frequent parameter changing is necessary, setting "0" (initial value) allows the operation mode to be changed easily to the PU operation mode by pressing  of the operation panel. When you switched to the PU operation mode, always return to the external operation mode.
- The STF and STR signal are used as a start command, and the voltage or current signal to terminal 2, 4, multi-speed signal, JOG signal, etc. are used as a frequency command.

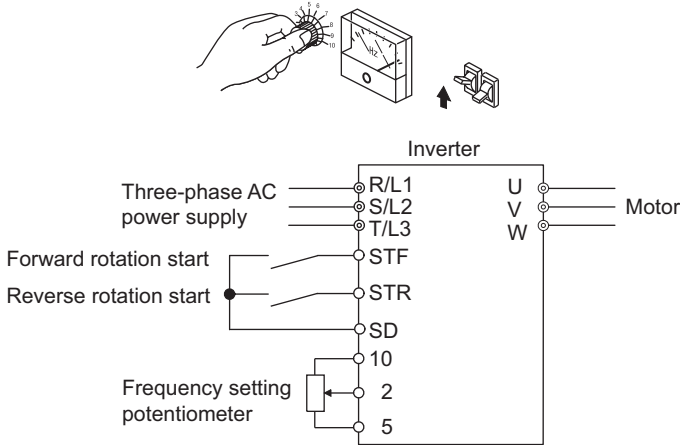

**(5) PU operation mode (setting "1")**

- Select the PU operation mode when applying start and speed command by only the key operation of the operation panel (FR-PU04/FR-PU07). Also select the PU operation mode when making communication using the PU connector.
- When "1" is selected for *Pr. 79*, the inverter enters the PU operation mode at power on. You cannot change to the other operation mode.
- The setting dial of the operation panel can be used for setting like a potentiometer. (Refer to *Pr. 161 Frequency setting/key lock operation selection (page 260)*)

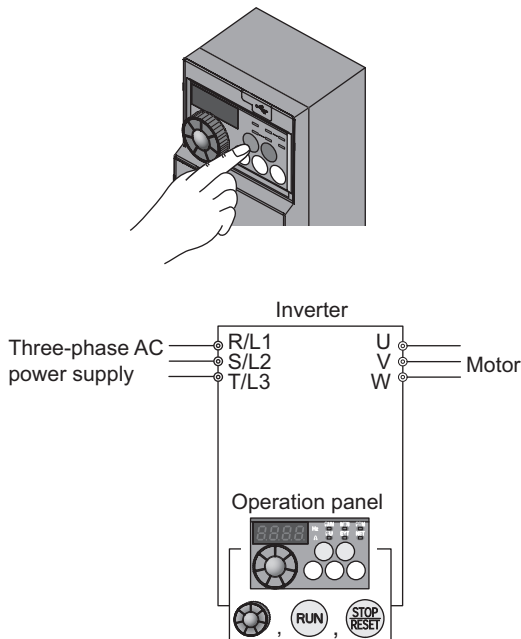

## 7 Selection of operation mode and operation location

### (6) PU/external combined operation mode 1 (setting "3")

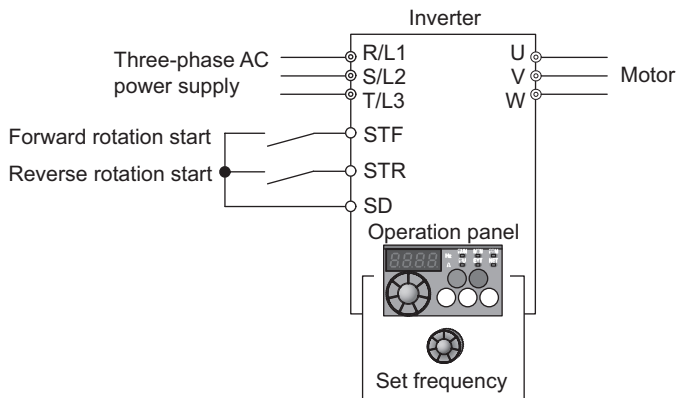
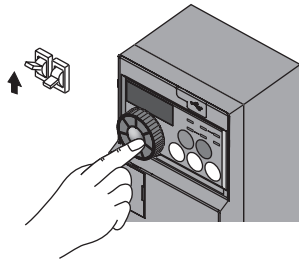

- Select the PU/external combined operation mode 1 when applying frequency command from the operation panel or parameter unit (FR-PU04/FR-PU07) and inputting the start command with the external start switch.
- Select "3" for *Pr: 79*. You cannot change to the other operation mode.
- When a frequency is applied from the external signal by multi-speed setting, it has a higher priority than the frequency command from the PU. When AU is on, the command signal to terminal 4 is used.

### (7) PU/external combined operation mode 2 (setting "4")

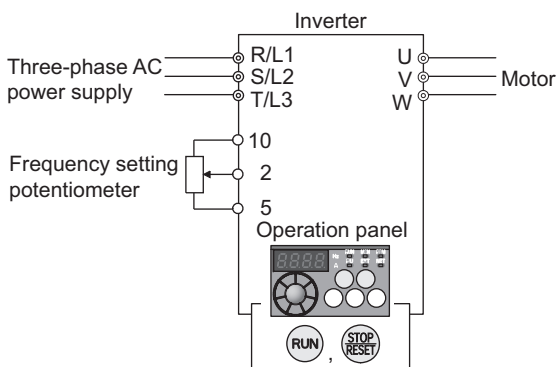
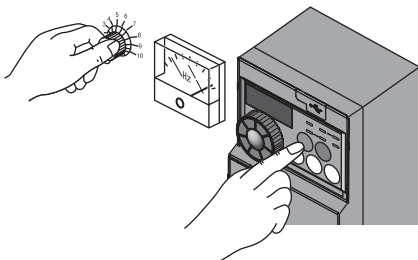

- Select the PU/external combined operation mode 2 when applying frequency command from the external potentiometer, multi-speed or JOG signal and inputting the start command by key operation of the operation panel (FR-PU04/FR-PU07).
- Select "4" for *Pr: 79*. You cannot change to the other operation mode.

### (8) Switch-over mode (setting "6")

- While continuing operation, you can switch between the PU operation, external operation and network operation (when RS-485 communication with the PU connector or communication option is used).

Operation Mode Switching	Switching Operation/Operating Status
External operation → PU operation	Select the PU operation mode with the operation panel or parameter unit. •Rotation direction is the same as that of external operation. •The frequency set with the potentiometer (frequency command) or like is used unchanged. (Note that the setting will disappear when power is switched off or the inverter is reset.)
External operation → NET operation	Send the mode change command to the network operation mode through communication. •Rotation direction is the same as that of external operation. •The value set with the setting potentiometer (frequency command) or like is used unchanged. (Note that the setting will disappear when power is switched off or the inverter is reset.)
PU operation → external operation	Press the external operation key of the parameter unit. •The rotation direction is determined by the input signal of the external operation. •The set frequency is determined by the external frequency command signal.
PU operation → NET operation	Send the mode change command to the network operation mode through communication. •Rotation direction and set frequency are the same as those of PU operation.
NET operation → external operation	Command to change to external mode is transmitted by communication. •Rotation direction is determined by the external operation input signal. •The set frequency is determined by the external frequency command signal.
NET operation → PU operation	Select the PU operation mode with the operation panel or parameter unit. •The rotation direction and frequency command in the network operation mode are used unchanged.

### (9) PU operation interlock (setting "7")

- The PU operation interlock function is designed to forcibly change the operation mode to the external operation mode when the PU operation interlock signal (X12) input turns off.  
 This function prevents the inverter from being inoperative by the external command if the mode is accidentally left unswitched from PU operation mode.
- Set "7" (PU operation interlock) in Pr. 79.
- For the terminal used for X12 signal (PU operation interlock signal) input, set "12" to any of Pr. 178 to Pr. 184 (input terminal function selection) to assign the function. (Refer to page 131 for Pr.178 to Pr.184.)
- When the X12 signal is not assigned, function of the MRS signal switches from MRS (output stop) to PU operation interlock signal.

X12 (MRS) Signal	Function/Operation	
	Operation mode	Parameter write
ON	Operation mode (external, PU, NET) switching enabled Output stop during external operation	Parameter write enabled (depending on Pr. 77 parameter write selection and each parameter write conditions (Refer to page 54 for the parameter list))
OFF	Forcibly switched to external operation mode External operation allowed Switching between the PU and Net operation mode is enabled	Parameter write disabled with exception of Pr. 79

#### <Function/operation changed by switching on-off the X12 (MRS) signal>

Operating Condition		X12 (MRS) Signal	Operation Mode	Operating Status	Switching to PU, NET Operation Mode
Operation mode	Status				
PU/NET	During stop	ON → OFF *1	External *2	If external operation frequency setting and start signal are entered, operation is performed in that status.	Disallowed
	Running	ON → OFF *1			Disallowed
External	During stop	OFF → ON	External *2	During stop During operation → output stop Output stop → operation	Allowed
		ON → OFF			Disallowed
	Running	OFF → ON			Disallowed
		ON → OFF			Disallowed

\*1 The operation mode switches to the external operation mode independently of whether the start signal (STF, STR) is on or off. Therefore, the motor is run in external operation mode when the X12 (MRS) signal is turned off with either of STF and STR on.

\*2 At fault occurrence, pressing of the operation panel resets the inverter.



### NOTE

- If the X12 (MRS) signal is on, the operation mode cannot be switched to the PU operation mode when the start signal (STF, STR) is on.
- When the MRS signal is used as the PU interlock signal, the MRS signal serves as the normal MRS function (output stop) by turning on the MRS signal and then changing the Pr. 79 value to other than "7" in the PU operation mode. As soon as "7" is set to Pr. 79, the MRS signal acts as the PU interlock signal.
- When the MRS signal is used as the PU interlock signal, the logic of the signal is as set in Pr. 17. When Pr. 17 = "2", read ON as OFF and OFF as ON in the above explanation.
- Changing the terminal assignment using Pr. 178 to Pr. 184 (input terminal function selection) may affect the other functions. Make setting after confirming the function of each terminal.

### (10) Switching of operation mode by external signal (X16 signal)

- When external operation and operation from the operation panel are used together, use of the PU-external operation switching signal (X16) allows switching between the PU operation mode and external operation mode during a stop (during a motor stop, start command off).
- When Pr. 79 = any of "0, 6, 7", the operation mode can be switched between the PU operation mode and external operation mode. (Pr. 79 = "6" Switch-over mode can be changed during operation)
- For the terminal used for X16 signal input, set "16" to any of Pr. 178 to Pr. 184 (input terminal function selection) to assign the function.

Pr. 79 Setting		X16 Signal State Operation Mode		Remarks
		ON (external)	OFF (PU)	
0 (initial value)		External operation mode	PU operation mode	Can be switched to external, PU or NET operation mode
1		PU operation mode		Fixed to PU operation mode
2		External operation mode		Fixed to external operation mode (can be switched to NET operation mode)
3, 4		External/PU combined operation mode		External/PU combined mode fixed
6		External operation mode	PU operation mode	Switching among the external, PU, and NET operation mode is enabled while running.
7	X12 (MRS) ON	External operation mode	PU operation mode	Can be switched to external, PU or NET operation mode (output stop in external operation mode)
	X12 (MRS) OFF	External operation mode		Fixed to external operation mode (forcibly switched to external operation mode)



### REMARKS

- The operation mode status changes depending on the setting of Pr. 340 Communication startup mode selection and the ON/OFF status of the X65 and X66 signals. (For details, refer to page 191)
- The priorities of Pr. 79, Pr. 340 and signals are Pr. 79 > X12 > X66 > X65 > X16 > Pr. 340.



### NOTE

- Changing the terminal assignment using Pr. 178 to Pr. 184 (input terminal function selection) may affect the other functions. Make setting after confirming the function of each terminal.



**(11) Switching of operation mode by external signals (X65, X66 signals)**

- When Pr. 79 = any of "0, 2, 6, 7", the operation mode switching signals (X65, X66) can be used to change the PU or external operation mode to the network operation mode during a stop (during a motor stop or start command off). (Pr. 79 = "6" Switch-over mode can be changed during operation)
- When switching between the network operation mode and PU operation mode
  - 1)Set Pr. 79 to "0" (initial value), "6" or "7".(At the Pr. 79 setting of "7", the operation mode can be switched when the X12 (MRS) signal turns on.)
  - 2)Set "10" in Pr. 340 Communication startup mode selection.
  - 3)Set "65" in any of Pr. 178 to Pr. 184 to assign the NET-PU operation switching signal (X65) to the terminal.
  - 4)The operation mode changes to the PU operation mode when the X65 signal turns on, or to the network operation mode when the X65 signal turns off.

Pr. 340 Setting	Pr. 79 Setting		X65 Signal State		Remarks
			ON (PU)	OFF (NET)	
10	0 (initial value)		PU operation mode *1	NET operation mode *2	Cannot be switched to external operation mode
	1		PU operation mode		Fixed to PU operation mode
	2		NET operation mode		Fixed to NET operation mode
	3, 4		External/PU combined operation mode		External/PU combined mode fixed
	6		PU operation mode *1	NET operation mode *2	Operation mode can be switched with operation continued Cannot be switched to external operation mode
	7	X12 (MRS) ON	PU operation mode *1	NET operation mode *2, *3	Output stop in external operation mode
X12 (MRS) OFF		External operation mode		Forcibly switched to external operation mode	

\*1 NET operation mode when the X66 signal is on.  
 \*2 PU operation mode is selected when the X16 signal is off. PU operation mode also when Pr. 550 NET mode operation command source selection= "0" (communication option control source) and the communication option is not fitted.  
 \*3 External operation mode when the X16 signal is on.

- When switching between the network operation mode and external operation mode
  - 1) Set Pr. 79 to "0 (initial value), 2, 6 or 7". (At the Pr. 79 setting of "7", the operation mode can be switched when the X12 (MRS) signal turns on.)
  - 2) Set "0 (initial value) or 1" in Pr. 340 Communication startup mode selection.
  - 3) Set "66" in any of Pr. 178 to Pr. 184 to assign the NET-PU operation switching signal (X66) to the terminal.
  - 4) The operation mode changes to the network operation mode when the X66 signal turns on, or to the external operation mode when the X66 signal turns off.

Pr. 340 Setting	Pr. 79 Setting		X66 Signal State		Remarks
			ON (NET)	OFF (external)	
0 (initial value)	0 (initial value)		NET operation mode *1	External operation mode *2	
	1		PU operation mode		Fixed to PU operation mode
	2		NET operation mode *1	External operation mode	Cannot be switched to PU operation mode
	3, 4		External/PU combined operation mode		External/PU combined mode fixed
	6		NET operation mode *1	External operation mode *2	Operation mode can be switched with operation continued
	7	X12 (MRS) ON	NET operation mode *1	External operation mode *2	Output stop in external operation mode
X12 (MRS) OFF		External operation mode		Forcibly switched to external operation mode	

\*1 PU operation mode is selected when Pr. 550 NET mode operation command source selection = "0" (communication option control source) and the communication option is not fitted.  
 \*2 PU operation mode is selected when the X16 signal is off. When the X65 signal has been assigned, the operation mode changes with the ON/OFF state of the X65 signal.



### REMARKS

- The priorities of Pr. 79 , Pr. 340 and signals are Pr. 79 > X12 > X66 > X65 > X16 > Pr. 340.



### NOTE

- Changing the terminal assignment using Pr. 178 to Pr. 184 (input terminal function selection) may affect the other functions. Make setting after confirming the function of each terminal.





### Parameters referred to

Pr. 15 Jog frequency  Refer to page 97

Pr. 4 to 6, Pr. 24 to 27, Pr. 232 to Pr. 239 Multi-speed operation  Refer to page 95

Pr. 75 Reset selection/disconnected PU detection/PU stop selection  Refer to page 176

Pr. 161 Frequency setting/key lock operation selection  Refer to page 260

Pr. 178 to Pr. 184 (input terminal function selection)  Refer to page 131

Pr. 190 to Pr. 192 (output terminal function selection)  Refer to page 137

Pr. 340 Communication startup mode selection  Refer to page 193

Pr. 550 NET mode operation command source selection  Refer to page 194

### 4.19.2 Operation mode at power-on (Pr. 79, Pr. 340)

When power is switched on or when power comes back on after instantaneous power failure, the inverter can be started up in the network operation mode.

After the inverter has started up in the network operation mode, parameter write and operation can be performed from a program.

Set this mode for communication operation using PU connector or communication option.

Parameter Number	Name	Initial Value	Setting Range	Description
79	Operation mode selection	0	0 to 4, 6, 7	Operation mode selection (Refer to page 186)
340 *	Communication startup mode selection	0	0	As set in Pr. 79.
			1	Network operation mode
			10	Network operation mode Operation mode can be changed between the PU operation mode and network operation mode from the operation panel.

The above parameters can be changed during a stop in any operation mode.

\* The above parameters can be set when Pr. 160 User group read selection = "0". However, the parameters can be set whenever the communication option is connected. (Refer to page 180)

#### (1) Specify operation mode at power-on (Pr. 340)

• Depending on the Pr. 79 and Pr. 340 settings, the operation mode at power-on (reset) changes as described below.

Pr. 340 Setting	Pr. 79 Setting	Operation Mode at Power-on, Power Restoration, Reset	Operation Mode Switching
0 (initial value)	0 (initial value)	External operation mode	Switching among the external, PU and Net operation mode is enabled *1
	1	PU operation mode	Fixed to PU operation mode
	2	External operation mode	Switching between the external and NET operation mode is enabled Switching to PU operation mode disabled
	3, 4	External/PU combined mode	Operation mode switching disabled
	6	External operation mode	Switching among the external, PU, and NET operation mode is enabled while running.
	7	X12 (MRS) signal ON .... External operation mode	Switching among the external, PU and Net operation mode is enabled *1
X12 (MRS) signal off..... External operation mode		Fixed to external operation mode (Forcibly switched to external operation mode.)	
1	0	NET operation mode	Same as when Pr. 340 = "0"
	1	PU operation mode	
	2	NET operation mode	
	3, 4	External/PU combined mode	
	6	NET operation mode	
	7	X12 (MRS) signal ON ..... NET operation mode	
X12(MRS) signal off..... External operation mode			
10	0	NET operation mode	Switching between the PU and Net operation mode is enabled *2
	1	PU operation mode	Same as when Pr. 340 = "0"
	2	NET operation mode	Fixed to NET operation mode
	3, 4	External/PU combined mode	Same as when Pr. 340 = "0"
	6	NET operation mode	Switching between the PU and NET operation mode is enabled while running *2
	7	External operation mode	Same as when Pr. 340 = "0"

\*1 Operation mode can not be directly changed between the PU operation mode and network operation mode

\*2 Operation mode can be changed between the PU operation mode and network operation mode with key of the operation panel and X65 signal.



#### Parameters referred to

Pr. 79 Operation mode selection Refer to page 183

### 4.19.3 Start command source and frequency command source during communication operation (Pr. 338, Pr. 339, Pr. 550, Pr. 551)

When the RS-485 communication with the PU connector or communication option is used, the external start command and frequency command can be made valid. Command source in the PU operation mode can be selected.

From the communication device, parameter unit, etc. which have command source, parameter write or start command can be executed. Parameter read or monitoring can be executed in any operation mode.

Parameter Number	Name	Initial Value	Setting Range	Description
338	Communication operation command source	0	0	Start command source communication
			1	Start command source external
339	Communication speed command source	0	0	Frequency command source communication
			1	Frequency command source external (Frequency command from communication is invalid, frequency command from terminal 2 is valid)
			2	Frequency command source external (Frequency command from communication is valid, frequency command from terminal 2 is invalid)
550 *	NET mode operation command source selection	9999	0	The communication option is the command source when NET operation mode.
			2	PU connector is the command source when NET operation mode.
			9999	Automatic communication option recognition Normally, PU connector is the command source. When a communication option is mounted, the communication option is the command source.
551 *	PU mode operation command source selection	9999	2	PU connector is the command source when PU operation mode.
			3	USB connector is the command source when PU operation mode.
			4	Operation panel is the command source when PU operation mode.
			9999	USB automatic recognition Normally, operation panel is the command source. When the parameter unit is connected to the PU connector, PU is the command source. When USB is connected, USB connector is the command source.

The above parameters can be set when Pr. 160 User group read selection = "0". However, the parameters can be set whenever the communication option is connected. (Refer to page 180)

\* Pr. 550 and Pr. 551 are always write-enabled.

#### (1) Select the command source of the network operation mode (Pr. 550)

- Either the RS-485 communication with the PU connector or communication option can be specified as the command source in the network operation mode.
- For example, set Pr. 550 to "2" when executing parameter write, start command or frequency command from the unit RS-485 terminals in the network operation mode independently of whether the communication option is connected or not.



#### NOTE

- Since Pr. 550 = "9999" (automatic communication option recognition) in the initial setting, parameter write, start command and frequency command cannot be executed by communication using the unit RS-485 terminals when the communication option is fitted.

### (2) Selects the command source of the PU operation mode (Pr. 551)

- Any of the operation panel, PU connector, or USB connector can be specified as the command source in the PU operation mode.
- In the PU operation mode, set Pr. 551 to "2" when executing parameter write, start command or frequency command during the RS-485 communication with PU communication.



#### NOTE

- When performing the RS-485 communication with the PU connector when Pr. 551 = "9999", PU mode command source does not automatically change to the PU connector. Change to the network operation mode to change the command source.
- When "2" (NET mode PU connector) is set in Pr. 550 and "2" (PU mode PU connector) is set in Pr. 551, PU operation mode has priority. When the communication option is not fitted, therefore, the operation mode cannot be switched to the network operation mode.
- Changed setting value is made valid when powering on or resetting the inverter.
- The Modbus-RTU protocol cannot be used in the PU operation mode. Select network operation mode (NET mode command source).

PU...PU operation mode, NET...network operation mode, —...without command source

Pr. 550 Setting	Pr. 551 Setting	Command Source				Communication option	Remarks
		Operation panel	USB connector	PU connector			
				Parameter unit	RS-485 communication		
0	2	—	—	PU	PU *1	NET *2	
	3	—	PU	—	—	NET *2	
	4	PU	—	—	—	NET *2	
	9999 (initial value)	PU *3	PU *3	PU *3	PU *1	NET *2	
2	2	—	—	PU	PU *1	—	Switching to NET operation mode disabled
	3	—	PU	—	NET	—	
	4	PU	—	—	NET	—	
	9999 (initial value)	PU *3	PU *3	PU *3	NET	NET	
9999 (initial value)	2	—	—	PU	PU *1	NET *2	
	3	—	PU	—	—	NET *2	Communication option fitted
				—	NET	—	Communication option not fitted
	4	PU	—	—	—	NET *2	Communication option fitted
				—	NET	—	Communication option not fitted
	9999 (initial value)	PU *3	PU *3	PU *3	—	NET *2	Communication option fitted
—				NET	—	Communication option not fitted	

\*1 The Modbus-RTU protocol cannot be used in the PU operation mode. When using the Modbus-RTU protocol, set Pr. 550 to "2".

\*2 When the communication option is not fitted, the operation mode cannot be switched to the network operation mode.

\*3 When Pr. 551 = "9999", the priorities of the PU control source is USB connector > parameter unit (FR-PU04/FR-PU07) > operation panel.

## (3) Controllability through communication

- Controllability through communication in each operation mode is shown below.
- Monitoring and parameter read can be performed from any operation regardless of operation mode.

Operation Location	Condition (Pr. 551 Setting)	Operation Mode Item	PU Operation	External Operation	External/PU Combined Operation Mode 1 (Pr. 79 = 3)	External/PU Combined Operation Mode 2 (Pr. 79 = 4)	NET Operation (when using PU connector) *6		NET Operation (when using communication option) *7
Control by RS-485 communication from PU connector	2 (PU connector)	Run command (start)	○	×	×	○			×
		Run command (stop)	○	△*3	△*3	○			△*3
		Running frequency setting	○	×	○	×			×
		Parameter write	○*4	×	○*4	○*4			×
		Inverter reset	○	○	○	○			○
	Other than the above	Run command (start)	×	×	×	×	○*1		×
		Run command (stop)	×	×	×	×	○*1		×
		Running frequency setting	×	×	×	×	○*1		×
		Parameter write	×	×	×	×	○*4		×
		Inverter reset	×	×	×	×	○*2		×
Operation from the USB connector	3 (USB connector) 9999 (automatic recognition)	Run command (start, stop)	○	×	×	○			×
		Running frequency setting	○	×	○	×			×
		Parameter write	○*4	×	×	×			×
		Inverter reset	○	○	○	○			○
	Other than the above	Run command (start, stop)	×	×	×	×			×
		Running frequency setting	×	×	×	×			×
		Parameter write	×	×	×	×			×
Control by communication from communication option	—	Inverter reset	○	○	○	○			○
		Run command (start, stop)	×	×	×	×	×		○*1
		Running frequency setting	×	×	×	×	×		○*1
		Parameter write	×	×	×	×	×		○*4
Control circuit external terminals	—	Inverter reset	○	○	○	○			○
		Run command (start, stop)	×	○	○	×			×
		Frequency setting	×	○	×	○			×

○: Enabled, ×: Disabled, △: Some are enabled

\*1 As set in Pr.338 Communication operation command source and Pr. 339 Communication speed command source (Refer to page 194)

\*2 At occurrence of RS-485 communication error, the inverter cannot be reset from the computer.

\*3 Enabled only when stopped by the PU. At a PU stop, PS is displayed on the operation panel. As set in Pr. 75 PU stop selection. (Refer to page 176)

\*4 Some parameters may be write-disabled according to the Pr. 77 Parameter write selection setting and operating status. (Refer to page 179)

\*5 Some parameters are write-enabled independently of the operation mode and command source presence/absence. When Pr. 77 = 2, write is enabled. (Refer to the parameter list on page 54) Parameter clear is disabled.

\*6 When Pr. 550 NET mode operation command source selection = "2" (PU connector valid) or Pr. 550 NET mode operation command source selection = "9999" and the communication option is not fitted.

\*7 When Pr. 550 NET mode operation command source selection= "0" (communication option valid) or Pr. 550 NET mode operation command source selection= "9999" and the communication option is fitted.

**(4) Operation at error occurrence**

Error Definition	Operation Mode	PU Operation	External Operation	External/PU Combined Operation Mode 1 (Pr. 79 = 3)	External/PU Combined Operation Mode 2 (Pr. 79 = 4)	NET Operation (when used with PU connector) *5	NET Operation (when used with communication option) *6
	Condition (Pr. 551 setting)						
Inverter fault	—	Stop					
PU disconnection of the PU	2 (PU connector) 9999 (automatic recognition)	Stop/continued *1, *4					
	Other than the above	Stop/continued*1					
RS-485 communication error of the PU connector	2 (PU connector)	Stop/continued*2	Continued		Stop/continued*2	—	Continued
	Other than the above	Continued				Stop/continued*3	Continued
Communication error of USB connector	3 (USB connector) 9999 (automatic recognition)	Stop/continued*2	Continued		Stop/continued*2	Continued	
	Other than the above	Continued					
Communication error of communication option	—	Continued				Stop/continued*3	Continued

- \*1 Can be selected using Pr. 75 Reset selection/disconnected PU detection/PU stop selection.
- \*2 Can be selected using Pr. 122 PU communication check time interval, Pr. 336 RS-485 communication check time interval, Pr. 548 USB communication check time interval.
- \*3 As controlled by the communication option.
- \*4 In the PU JOG operation mode, operation is always stopped when the PU is disconnected. Whether fault (E.PUE) occurrence is allowed or not is as set in Pr. 75 Reset selection/disconnected PU detection/PU stop selection.
- \*5 When Pr. 550 NET mode operation command source selection = "2" (PU connector valid) or Pr. 550 NET mode operation command source selection = "9999" and the communication option is not fitted.
- \*6 When Pr. 550 NET mode operation command source selection = "0" (communication option valid) or Pr. 550 NET mode operation command source selection = "9999" and the communication option is fitted.

## 7 Selection of operation mode and operation location

### (5) Selection of control source in network operation mode (Pr. 338, Pr. 339)

- As control sources, there are the operation command source that controls the signals related to the inverter start command and function selection and the speed command source that controls the signals related to frequency setting.
- In network operation mode, the commands from the external terminals and communication (PU connector or communication option) are as listed below.

Operation Location Selection	Pr. 338 Communication operation command source		0: NET			1: External			Remarks		
	Pr. 339 Communication speed command source		0: NET	1: External	2: External	0: NET	1: External	2: External			
Fixed function (terminal-equivalent function)	Running frequency from communication		NET	—	NET	NET	—	NET			
	Terminal 2		—	External	—	—	External	—			
	Terminal 4		—	External		—	External				
Selective function Pr. 178 to Pr. 184 setting	0	RL	Low speed operation command/remote setting clear/stop-on contact selection 0		NET	External		NET	External		Pr. 59 = "0" (multi-speed) Pr. 59 = "1, 2" (remote) Pr. 270 = "1" (stop-on-contact)
	1	RM	Middle speed operation command/remote setting function		NET	External		NET	External		
	2	RH	High speed operation command/remote setting function		NET	External		NET	External		
	3	RT	Second function selection/stop-on contact selection 1		NET			External			Pr. 270 = "1" (stop-on-contact)
	4	AU	Current input selection		—	Combined		—	Combined		
	5	JOG	Jog operation selection		—			External			
	7	OH	External thermal relay input		External						
	8	REX	Fifteen speed selection		NET	External		NET	External		Pr. 59 = "0" (multi-speed)
	10	X10	Inverter operation enable signal		External						
	12	X12	PU operation external interlock		External						
	14	X14	PID control valid terminal		NET	External		NET	External		
	15	BRI	Brake opening completion signal		NET			External			
	16	X16	PU-external operation switchover		External						
	18	X18	V/F switching		NET			External			
	24	MRS	Output stop		Combined			External			Pr. 79 ≠ "7"
			PU operation interlock		External						Pr. 79 = "7" When the X12 signal is not assigned
	25	STOP	Start self-holding selection		—			External			
60	STF	Forward rotation command		NET			External				
61	STR	Reverse rotation command		NET			External				
62	RES	Reset		External							
65	X65	PU/NET operation switchover		External							
66	X66	NET-external operation switching		External							
67	X67	Command source switchover		External							

#### [Explanation of table]

- External : Command is valid only from control terminal.  
NET : Command only from communication is valid  
Combined : Command from both control terminal and communication is valid.  
— : Command from either of control terminal and communication is invalid.



#### REMARKS

- The command source of communication is as set in Pr. 550 and Pr. 551 .
- The Pr. 338 and Pr. 339 settings can be changed while the inverter is running when Pr. 77 = "2". Note that the setting change is reflected after the inverter has stopped. Until the inverter has stopped, communication operation command source and communication speed command source before the setting change are valid.



**(6) Switching of command source by external terminal (X67)**

- In the network operation mode, the command source switching signal (X67) can be used to switch the start command source and speed command source.
- Set "67" to any of *Pr. 178 to Pr. 184 (input terminal function selection)* to assign the X67 signal to the control terminal.
- When the X67 signal is off, the start command source and speed command source are control terminal.

X67 Signal State	Start Command Source	Speed Command Source
No signal assignment	According to <i>Pr. 338</i>	According to <i>Pr. 339</i>
ON	Command is valid only from control terminal.	
OFF	Command is valid only from control terminal.	



**REMARKS**

- The ON/OFF state of the X67 signal is reflected only during a stop. It is reflected after a stop when the terminal is switched while the inverter is running.
- When the X67 signal is off, a reset via communication is disabled.



**NOTE**

- Changing the terminal assignment using *Pr. 178 to Pr. 184 (input terminal function selection)* may affect the other functions. Make setting after confirming the function of each terminal.



**Parameters referred to**

- Pr. 59 Remote function selection* Refer to page 99
- Pr. 79 Operation mode selection* Refer to page 183
- Pr. 270 Stop-on-contact control selection* Refer to page 125

## 4.20 Communication operation and setting

Purpose	Parameter that should be Set		Refer to Page
Communication operation from PU connector	Initial setting of computer link communication (PU connector)	Pr. 117 to Pr. 124	203
	Modbus-RTU communication specifications	Pr. 117, Pr. 118, Pr. 120, Pr. 122, Pr. 343, Pr. 502, Pr. 549	220
Restrictions on parameter write through communication	Communication EEPROM write selection	Pr. 342	207
Communication using USB (FR Configurator)	USB communication	Pr. 547, Pr. 548	233

### 4.20.1 Wiring and configuration of PU connector

Using the PU connector, you can perform communication operation from a personal computer etc.

When the PU connector is connected with a personal, FA or other computer by a communication cable, a user program can run and monitor the inverter or read and write to parameters.

#### (1) PU connector pin-outs

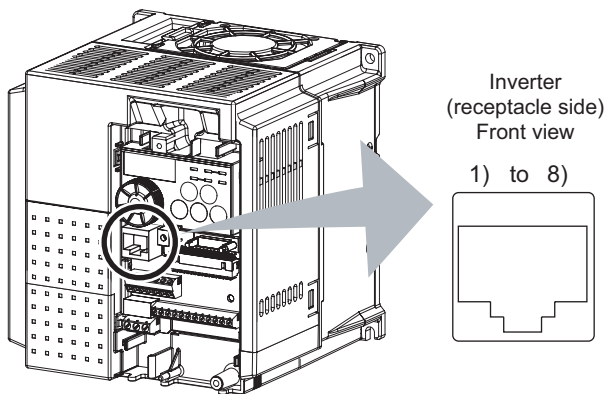

Pin Number	Name	Description
1)	SG	Earth (ground) (connected to terminal 5)
2)	—	Parameter unit power supply
3)	RDA	Inverter receive+
4)	SDB	Inverter send-
5)	SDA	Inverter send+
6)	RDB	Inverter receive-
7)	SG	Earth (ground) (connected to terminal 5)
8)	—	Parameter unit power supply



#### NOTE

- Pins No. 2 and 8 provide power to the operation panel or parameter unit. Do not use these pins for RS-485 communication.

- When making RS-485 communication between the FR-E700 series, FR-E500 series and FR-S500 series, incorrect connection of pins No.2 and No.8 (parameter unit power supply) of the above PU connector may result in the inverter malfunction or failure.

When multiple inverters are connected using pins No.2 and No.8, power is provided from the inverter which is powered on to the inverters which are powered off in case inverters which are powered on and off are mixed. In such a case, a protective circuit of the inverter, which is on, functions to stop communication.

When connecting multiple inverters for RS-485 communication, make sure to disconnect cables from No.2 and No.8 so that pins No.2 and No.8 are not connected between inverters.

When using the RS-485 converter which receives power from the inverter, make sure that power is provided from one inverter only. (Refer to the figure below.)

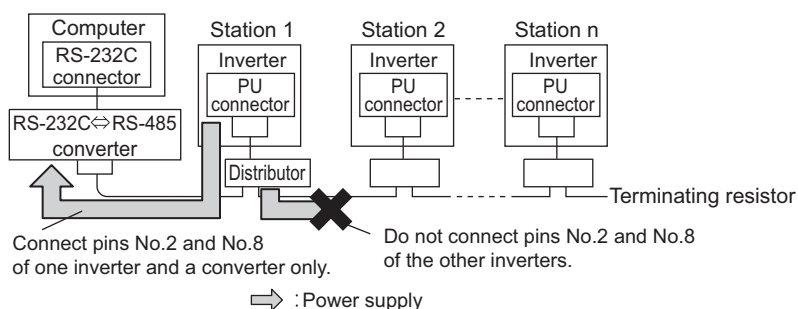
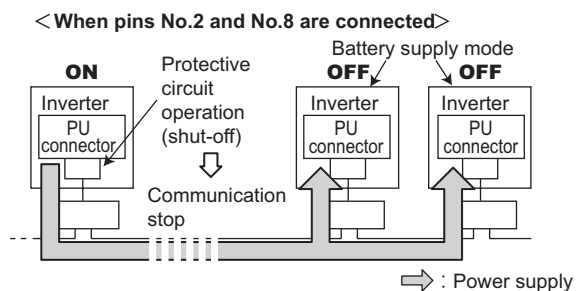

- Do not connect the PU connector to the computer's LAN board, FAX modem socket or telephone modular connector. The product could be damaged due to differences in electrical specifications.

(2) PU connector communication system configuration

●Connection of a computer to the inverter (1:1 connection)

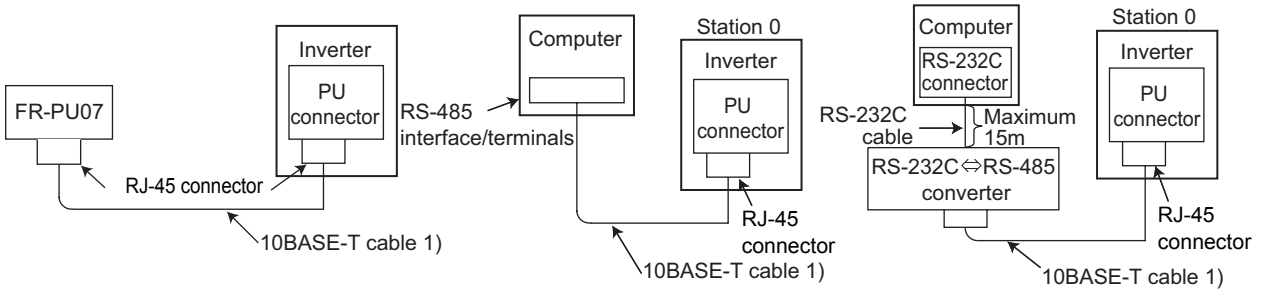

●Combination of computer and multiple inverters (1:n connection)

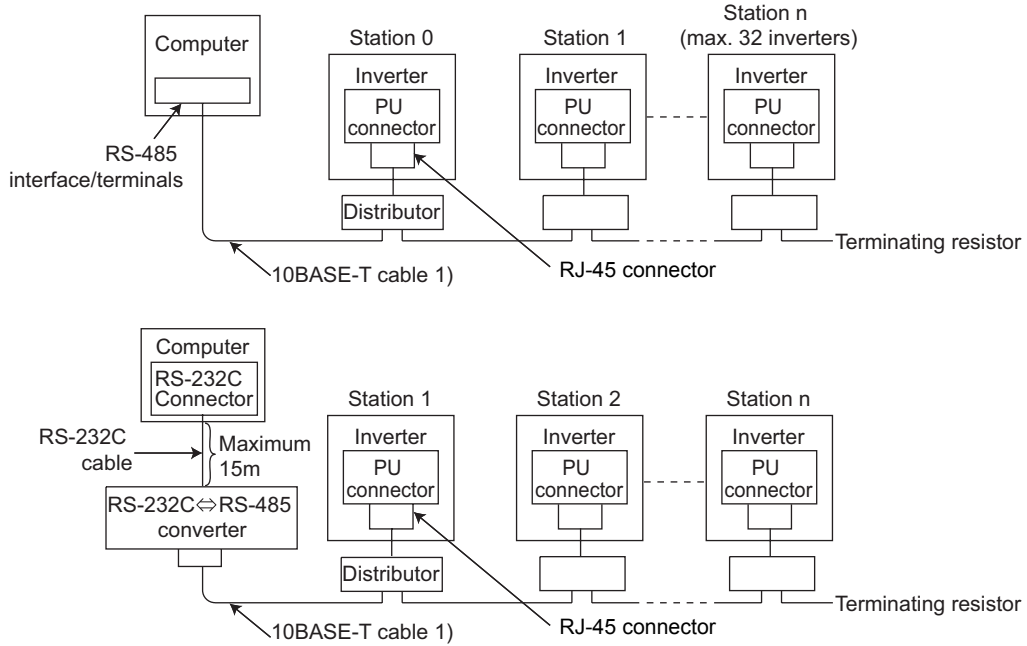

**REMARKS**

- Computer-inverter connection cable  
Refer to the following for the cable (RS-232C ↔ RS-485 converter) for connection of the computer having the RS-232C interface with the inverter. Examples of product available on the market (as of September, 2006)

Type	Maker
FA-T-RS40 series *1	Mitsubishi Electric Engineering Co., Ltd.

\*1 The converter cable cannot connect two or more inverters (the computer and inverter are connected on a 1:1 basis). Since the product is packed with the RS-232C cable and RS-485 cable (10BASE-T cable + RJ-45 connector), the cable and connector need not be prepared separately. Contact a maker for details of the product.

- Refer to the following when fabricating the cable on the user side.  
Examples of product available on the market (as of September, 2006)

	Product	Type	Maker
1)	10BASE-T cable	SGLPEV-T 0.5mm × 4P *2	Mitsubishi Cable Industries, Ltd.

\*2 Do not use pins No. 2, 8 of the 10BASE-T cable. (Refer to page 200)

## (3) Connection with RS-485 computer

### ●Wiring of one RS-485 computer and one inverter

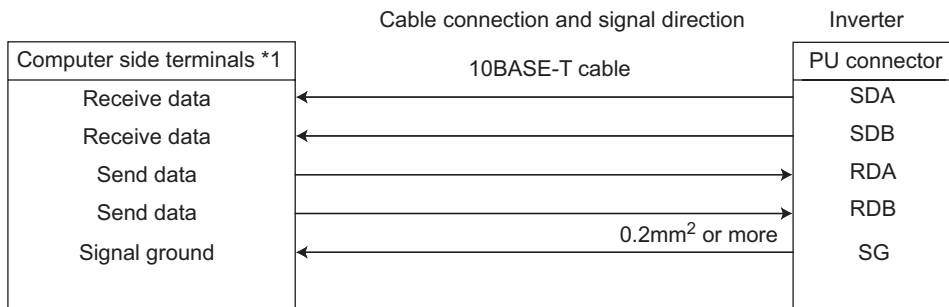

### ●Wiring of one RS-485 computer and "n" (multiple) inverters

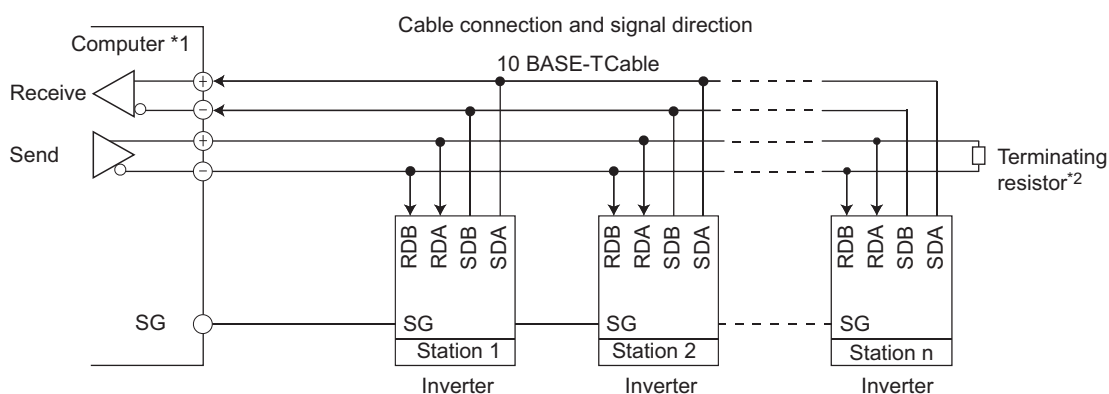

- \*1 Make connection in accordance with the instruction manual of the computer to be used with. Fully check the terminal numbers of the computer since they vary with the model.
- \*2 The inverters may be affected by reflection depending on the transmission speed or transmission distance. If this reflection hinders communication, provide a terminating resistor. If the PU connector is used to make a connection, use a distributor since a terminating resistor cannot be fitted. Connect the terminating resistor to only the inverter remotest from the computer. (Terminating resistor: 100Ω)



#### NOTE

- Do not use pins No. 2, 8 of the 10BASE-T cable. (Refer to page 200)
- When making RS-485 communication between the FR-E700 series, FR-E500 series and FR-S500 series, incorrect connection of pins No.2 and 8 (parameter unit power supply) of the above PU connector may result in the inverter malfunction or failure. (Refer to page 200)

## (4) Two-wire type connection

If the computer is 2-wire type, a connection from the inverter can be changed to 2-wire type by passing wires across reception terminals and transmission terminals of the PU connector pin.

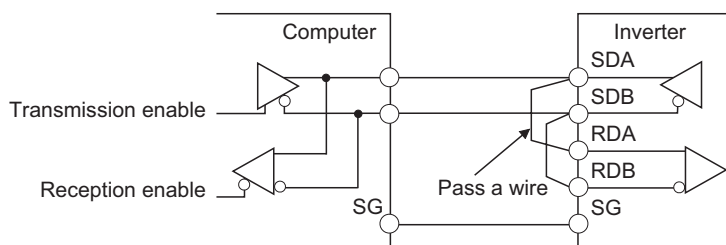

#### REMARKS

- A program should be created so that transmission is disabled (receiving state) when the computer is not sending and reception is disabled (sending state) during sending to prevent the computer from receiving its own data.
- The passed wiring length should be as short as possible.

**4.20.2 Initial settings and specifications of RS-485 communication**  
 (Pr. 117 to Pr. 120, Pr. 123, Pr. 124, Pr. 549)

Used to perform required settings for RS-485 communication between the inverter and personal computer.

- Use PU connector of the inverter for communication.
- You can perform parameter setting, monitoring, etc. using Mitsubishi inverter protocol or Modbus-RTU protocol.
- To make communication between the personal computer and inverter, initialization of the communication specifications must be made to the inverter.

Data communication cannot be made if the initial settings are not made or there is any setting error.

Parameter Number	Name	Initial Value	Setting Range	Description	
117	PU communication station number	0	0 to 31 (0 to 247) *1	Inverter station number specification Set the inverter station numbers when two or more inverters are connected to one personal computer.	
118	PU communication speed	192	48, 96, 192, 384	Communication speed The setting value X 100 equals the communication speed. Example) 19200bps if 192	
119	PU communication stop bit length	1		Stop bit length	Data length
			0	1bit	8bit
			1	2bit	
			10	1bit	7bit
11	2bit				
120	PU communication parity check	2	0	Without parity check	
			1	With odd parity check	
			2	With even parity check	
123	PU communication waiting time setting	9999	0 to 150ms	Set the waiting time between data transmission to the inverter and response.	
			9999	Set with communication data.	
124	PU communication CR/LF selection	1	0	Without CR/LF	
			1	With CR	
			2	With CR/LF	
549	Protocol selection	0	0	Mitsubishi inverter (computer link operation) protocol	
			1	Modbus-RTU protocol	

The above parameters can be set when Pr. 160 User group read selection = "0". (Refer to page 180)

\*1 When "1" (Modbus-RTU protocol) is set in Pr. 549, the setting range within parenthesis is applied.



**NOTE**

- Always reset the inverter after making the initial settings of the parameters. After you have changed the communication-related parameters, communication cannot be made until the inverter is reset.

## 4.20.3 Operation selection at communication error occurrence (Pr. 121, Pr. 122, Pr. 502)

You can select the inverter operation when a communication line error occurs during RS-485 communication from the PU connector.

Parameter Number	Name	Initial Value	Setting Range	Description																			
121	Number of PU communication retries	1	0 to 10	Number of retries at data receive error occurrence. If the number of consecutive errors exceeds the permissible value, the inverter will come to trip (depends on Pr. 502). Valid only Mitsubishi inverter (computer link operation) protocol.																			
			9999	If a communication error occurs, the inverter will not come to trip.																			
122	PU communication check time interval	0	0	RS-485 communication can be made. Note that a communication fault (E.PUE) occurs as soon as the inverter is switched to the operation mode with command source.																			
			0.1 to 999.8s	Communication check (signal loss detection) time interval. If a no-communication state persists for longer than the permissible time, the inverter will come to trip (depends on Pr. 502).																			
			9999	No communication check (signal loss detection)																			
502	Stop mode selection at communication error	0		<table border="1"> <thead> <tr> <th>At fault occurrence</th> <th>Indication</th> <th>Fault output</th> <th>At fault removal</th> </tr> </thead> <tbody> <tr> <td>0, 3</td> <td>Coasts to stop</td> <td>E.PUE</td> <td>Output</td> <td>Stop (E.PUE)</td> </tr> <tr> <td>1</td> <td>Decelerates to stop</td> <td>After stop E.PUE</td> <td>Output after stop</td> <td>Stop (E.PUE)</td> </tr> <tr> <td>2</td> <td>Decelerates to stop</td> <td>After stop E.PUE</td> <td>Without output</td> <td>Automatic restart functions</td> </tr> </tbody> </table>	At fault occurrence	Indication	Fault output	At fault removal	0, 3	Coasts to stop	E.PUE	Output	Stop (E.PUE)	1	Decelerates to stop	After stop E.PUE	Output after stop	Stop (E.PUE)	2	Decelerates to stop	After stop E.PUE	Without output	Automatic restart functions
			At fault occurrence	Indication	Fault output	At fault removal																	
			0, 3	Coasts to stop	E.PUE	Output	Stop (E.PUE)																
1	Decelerates to stop	After stop E.PUE	Output after stop	Stop (E.PUE)																			
2	Decelerates to stop	After stop E.PUE	Without output	Automatic restart functions																			
0, 3	Coasts to stop	E.PUE	Output	Stop (E.PUE)																			
1	Decelerates to stop	After stop E.PUE	Output after stop	Stop (E.PUE)																			
2	Decelerates to stop	After stop E.PUE	Without output	Automatic restart functions																			

The above parameters can be set when Pr. 160 User group read selection = "0". However, it can be set any time when the communication option is connected. (Refer to page 180)

### (1) Retry count setting (Pr.121)

- Set the permissible number of retries at data receive error occurrence. (Refer to page 212 for data receive error for retry)
- When data receive errors occur consecutively and exceed the permissible number of retries set, an inverter trips (E.PUE) and a motor stops (as set in Pr. 502).
- When "9999" is set, an inverter fault is not provided even if data receive error occurs but an alarm signal (LF) is output. For the terminal used for the LF signal output, assign the function by setting "98 (positive logic) or 198 (negative logic)" in any of Pr. 190 to Pr. 192 (output terminal function selection).

Example: PU connector communication, Pr. 121 = "1" (initial value)

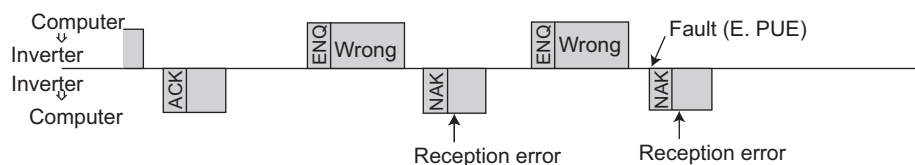

Example: PU connector communication, Pr. 121 = "9999"

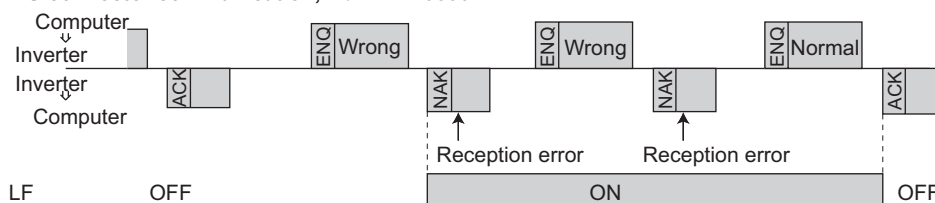

### REMARKS

- Pr. 121 is valid only when Mitsubishi inverter (computer link operation) protocol is selected. Pr. 121 is not valid when Modbus-RTU communication protocol is selected.



**(2) Signal loss detection (Pr.122)**

- If a signal loss (communication stop) is detected between the inverter and master as a result of a signal loss detection, a communication fault (E.PUE) occurs and the inverter trips. (as set in Pr. 502).
- When the setting is "9999", communication check (signal loss detection) is not made.
- When the setting value is "0" (initial value), RS-485 communication can be made. However, a communication fault (E.PUE) occurs as soon as the inverter is switched to the operation mode (network operation mode in the initial setting) with the control.
- A signal loss detection is made when the setting is any of "0.1s to 999.8s". To make a signal loss detection, it is necessary to send data (refer to Mitsubishi inverter protocol control code (page 211), Modbus-RTU communication protocol (page 221)) from the computer within the communication check time interval. (The inverter makes communication check (clearing of communication check counter) regardless of the station number setting of the data sent from the master).
- Communication check is made from the first communication in the operation mode with control source valid (network operation mode in the initial setting).

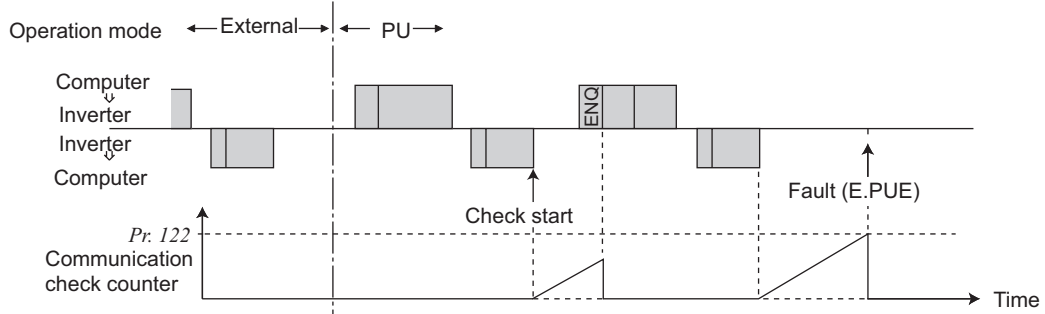
Example: PU connector communication, Pr. 122 = "0.1 to 999.8s"



 **CAUTION**

-  Always set the communication check time interval before starting operation to prevent hazardous conditions. Data communication is not started automatically but is made only once when the computer provides a communication request. If communication is disabled during operation due to signal cable breakage etc., the inverter cannot be stopped. When the communication check time interval has elapsed, the inverter trips (E.PUE).  
The inverter can be coasted to a stop by turning on its RES signal or by switching power off.
-  If communication is broken due to signal cable breakage, computer fault, etc. the inverter does not detect such a fault. This should be fully noted.

## (3) Stop operation selection at occurrence of communication fault (Pr. 502)

• Stop operation when retry count excess (Mitsubishi inverter protocol only) or signal loss detection error occurs can be selected.

Operation at fault occurrence

Pr. 502 Setting	Operation	Indication	Fault Output
0 (initial value)	Coasts to stop.	E. PUE lit	Provided
1	Decelerates to stop	E. PUE lit after stop	Provided after stop
2			Not provided
3	Same as the setting "0"		

Operation at fault removal

Pr. 502 Setting	Operation	Indication	Fault Output
0 (initial value)	Kept stopped	E. PUE	Kept provided
1			Not provided
2	Automatic restart functions	Normal display	Not provided
3	Same as the setting "0"		

●Pr. 502 setting "0 (initial value), 3"

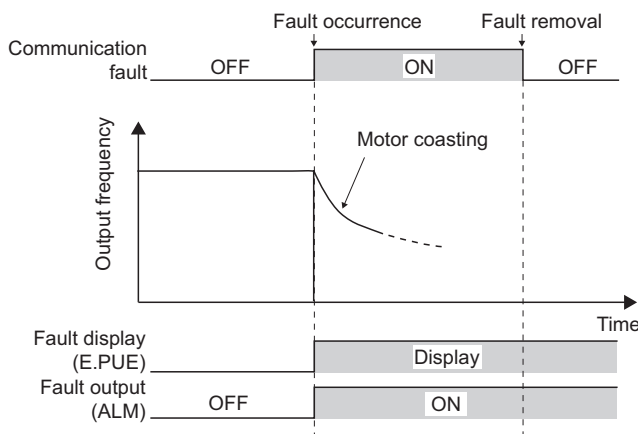

●Pr. 502 setting "1"

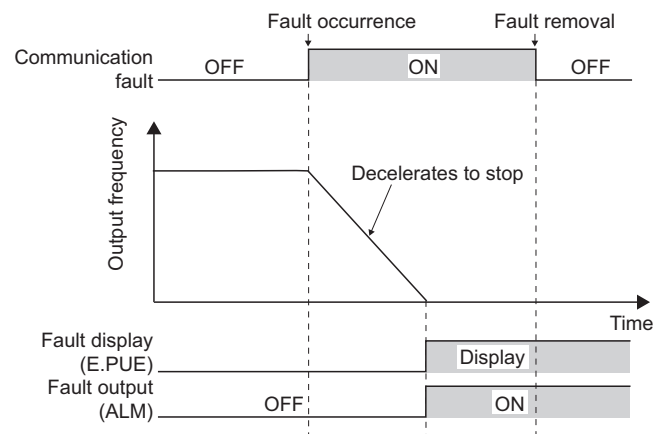

●Pr. 502 setting "2"

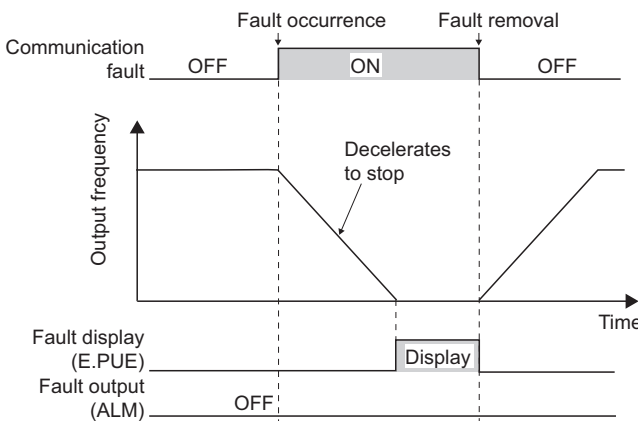

### REMARKS

- The fault output indicates fault output signal (ALM signal) or alarm bit output.
- When the setting was made to provide a fault output, the fault description is stored into the faults history. (The fault description is written to the faults history when a fault output is provided.)  
When no fault output is provided, the fault definition overwrites the fault indication of the faults history temporarily, but is not stored.  
After the fault is removed, the fault indication returns to the ordinary monitor, and the faults history returns to the preceding fault indication.
- When the Pr. 502 setting is "1 or 2", the deceleration time is the ordinary deceleration time setting (e.g. Pr. 8, Pr. 44, Pr. 45). In addition, acceleration time for restart is the normal acceleration time (e.g. Pr. 7, Pr. 44).
- When "2" is set in Pr. 502, run command/speed command at restarting follows the command before an fault occurrence.
- When "2" is set in Pr. 502 at occurrence of a communication error and the error is removed during deceleration, the inverter accelerates again at that point.



### Parameters referred to

Pr. 7 Acceleration time, Pr. 8 Deceleration time Refer to page 102  
Pr. 190 to Pr. 192 (output terminal function selection) Refer to page 137



#### 4.20.4 Communication EEPROM write selection (Pr. 342)

When parameter write is performed from the inverter PU connector, USB communication, and communication option, parameters storage device can be changed from EEPROM + RAM to RAM only. Set when a frequent parameter change is necessary.

Parameter Number	Name	Initial Value	Setting Range	Description
342	Communication EEPROM write selection	0	0	Parameter values written by communication are written to the EEPROM and RAM.
			1	Parameter values written by communication are written to RAM.

The above parameters can be set when Pr. 160 User group read selection = "0". However, it can be set any time when the communication option is connected. (Refer to page 180)

- When changing the parameter values frequently, set "1" in Pr. 342 to write them to the RAM only. The life of the EEPROM will be shorter if parameter write is performed frequently with the setting unchanged from "0 (initial value)" (EEPROM write).

 **REMARKS**

- When "1" (write to RAM only) is set in Pr. 342, powering off the inverter will erase the changed parameter values. Therefore, the parameter values available when power is switched on again are the values stored in EEPROM previously.

## 4.20.5 Mitsubishi inverter protocol (computer link communication)

You can perform parameter setting, monitor, etc. from the PU connector of the inverter using the Mitsubishi inverter protocol (computer link communication).

### (1) Communication

- The communication specifications are given below.

Item	Description	Related Parameter	
Communication protocol	Mitsubishi protocol (computer link)	Pr. 549	
Conforming standard	EIA-485 (RS-485)	—	
Number of connectable devices	1:N (maximum 32 units), setting is 0 to 31 stations	Pr. 117	
Communication speed	PU connector Selected from among 4800/9600/19200 and 38400bps	Pr. 118	
Control procedure	Asynchronous	—	
Communication method	Half-duplex	—	
Communication	Character system	ASCII (7 bits or 8 bits can be selected)	Pr. 119
	Start bit	1bit	—
	Stop bit length	1 bit or 2 bits can be selected	Pr. 119
	Parity check	Check (even, odd) or no check can be selected	Pr. 120
	Error check	Sum code check	—
	Terminator	CR/LF (presence/absence selectable)	Pr. 124
Waiting time setting	Selectable between presence and absence	Pr. 123	

### (2) Communication procedure

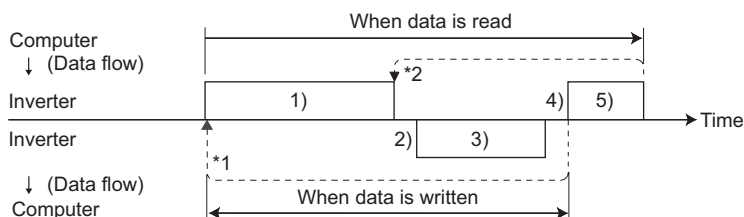

- Data communication between the computer and inverter is made in the following procedure.

- Request data is sent from the computer to the inverter. (The inverter will not send data unless requested.)
- After waiting for the waiting time
- The inverter sends return data to the computer in response to the computer request.
- After waiting for the inverter data processing time
- Answer from the computer in response to reply data 3) of the inverter is transmitted. (Even if 5) is not sent, subsequent communication is made properly.)

\*1 If a data error is detected and a retry must be made, execute retry operation with the user program. The inverter comes to trip if the number of consecutive retries exceeds the parameter setting.

\*2 On receipt of a data error occurrence, the inverter returns retry data 3) to the computer again. The inverter comes to trip if the number of consecutive data errors reaches or exceeds the parameter setting.

**(3) Communication operation presence/absence and data format types**

- Data communication between the computer and inverter is made in ASCII code (hexadecimal code).
- Communication operation presence/absence and data format types are as follows:

No.	Operation	Run Command	Operation Frequency	Parameter Write	Inverter Reset	Monitor	Parameter Read	
1)	Communication request is sent to the inverter in accordance with the user program in the computer.	A'	A, A" *3	A, A" *3	A	B	B	
2)	Inverter data processing time	Present	Present	Present	Absent	Present	Present	
3)	Reply data from the inverter (Data 1) is checked for error)	No error *1 (Request accepted)	C	C	C	C *2	E, E', E" *3	E, E" *3
		With error. (Request rejected)	D	D	D	D *2	D	D
4)	Computer processing delay time	Absent	Absent	Absent	Absent	Absent	Absent	
5)	Answer from computer in response to reply data 3). (Data 3) is checked for error)	No error *1 (No inverter processing)	Absent	Absent	Absent	Absent	Absent (C)	Absent (C)
		With error. (Inverter outputs 3) again.)	Absent	Absent	Absent	Absent	F	F

- \*1 In the communication request data from the computer to the inverter, 10ms or more is also required after "no data error (ACK)". (Refer to page 211)
- \*2 Reply from the inverter to the inverter reset request can be selected. (Refer to page 215)
- \*3 When any of "0.01 to 9998" is set in Pr. 37 and "01" in instruction code HFF sets data format to "A" or "E". In addition, data format is always A" and E" for read or write of Pr. 37.

1) Communication request data from the computer to the inverter

Format	Number of Characters														
	1	2	3	4	5	6	7	8	9	10	11	12	13	14	15
<b>A</b> (Data write)	ENQ *1	Inverter station number *2		Instruction code		Waiting Time *3	Data				Sum check		*4		
<b>A'</b> (Data write)	ENQ *1	Inverter station number *2		Instruction code		Waiting Time *3	Data		Sum check		*4				
<b>A"</b> (Data write)	ENQ *1	Inverter station number *2		Instruction code		Waiting Time *3	Data					Sum check		*4	
<b>B</b> (Data read)	ENQ *1	Inverter station number *2		Instruction code		Waiting Time *3	Sum check		*4						

3) Reply data from the inverter to the computer

- When data is written

Format	Number of Characters				
	1	2	3	4	5
<b>C</b> (Without data error)	ACK *1	Inverter station number *2		*4	
<b>D</b> (With data error)	NAK *1	Inverter station number *2		Error code *4	

- When data is read

Format	Number of Characters													
	1	2	3	4	5	6	7	8	9	10	11	12	13	
<b>E</b> (Without data error)	STX *1	Inverter station number *2		Read data				ETX *1	Sum check		*4			
<b>E'</b> (Without data error)	STX *1	Inverter station number *2		Read data		ETX *1	Sum check		*4					
<b>E"</b> (Without data error)	STX *1	Inverter station number *2		Read data						ETX *1	Sum check		*4	
<b>D</b> (With data error)	NAK *1	Inverter station number *2		Error code	*4									

### 5) Send data from computer to inverter during data read

Format	Number of Characters			
	1	2	3	4
<b>C</b> (Without data error)	ACK *1	Inverter station number *2		*4
<b>F</b> (With data error)	NAK *1	Inverter station number *2		*4

\*1 Indicate a control code

\*2 Specify the inverter station numbers between H00 and H1F (stations 0 to 31) in hexadecimal.

\*3 When the *Pr. 123 (waiting time setting)* is other than 9999, create the communication request data without "waiting time" in the data format. (The number of characters decreases by 1.)

\*4 CR, LF code

When data is transmitted from the computer to the inverter, codes CR (carriage return) and LF (line feed) are automatically set at the end of a data group on some computers. In this case, setting must also be made on the inverter according to the computer. Whether the CR and LF codes will be present or absent can be selected using *Pr. 124 (CR, LF selection)*.

(4) Data definitions

1) Control code

Signal	ASCII Code	Description
STX	H02	Start of Text (Start of data)
ETX	H03	End of Text (End of data)
ENQ	H05	Enquiry (Communication request)
ACK	H06	Acknowledge (No data error detected)
LF	H0A	Line Feed
CR	H0D	Carriage Return
NAK	H15	Negative Acknowledge (Data error detected)

2) Inverter station number

Specify the station number of the inverter which communicates with the computer.

3) Instruction code

Specify the processing request, e.g. operation or monitoring, given by the computer to the inverter. Hence, the inverter can be run and monitored in various ways by specifying the instruction code as appropriate. (Refer to page 54)

4) Data

Indicates the data such as frequency and parameters transferred to and from the inverter. The definitions and ranges of set data are determined in accordance with the instruction codes. (Refer to page 54)

5) Waiting time

Specify the waiting time between the receipt of data at the inverter from the computer and the transmission of reply data. Set the waiting time in accordance with the response time of the computer between 0 and 150ms in 10ms increments. (e.g. 1 = 10ms, 2 = 20ms).

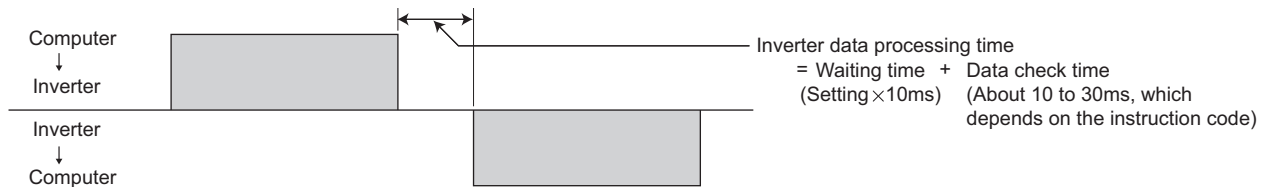

**REMARKS**

- When the Pr. 123, Pr. 337 (waiting time setting) setting is other than 9999, create the communication request data without "waiting time" in the data format. (The number of characters decreases by 1.)
- The data check time changes depending on the instruction code. (Refer to page 212)

6) Sum check code

The sum check code is 2-digit ASCII (hexadecimal) representing the lower 1 byte (8 bits) of the sum (binary) derived from the checked ASCII data.

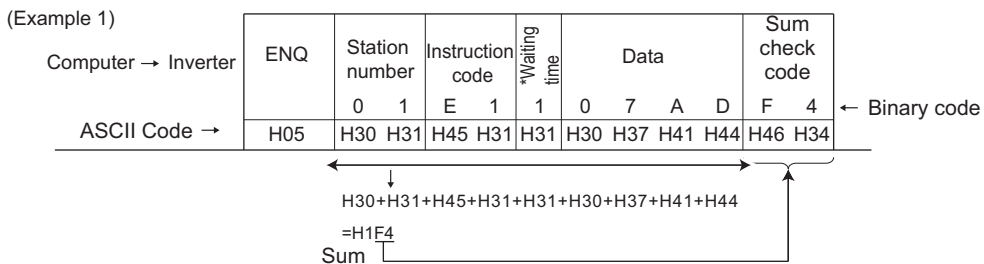

\* When the Pr. 123 Waiting time setting ≠ "9999", create the communication request data without "waiting time" in the data format. (The number of characters decreases by 1.)

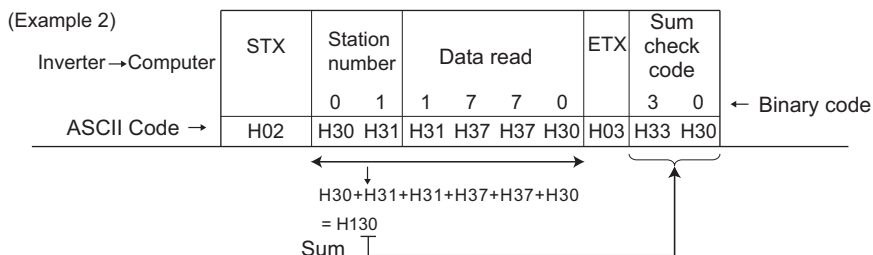

## 7) Error code

If any error is found in the data received by the inverter, its definition is sent back to the computer together with the NAK code.

Error Code	Error Item	Error Description	Inverter Operation
H0	Computer NAK error	The number of errors consecutively detected in communication request data from the computer is greater than allowed number of retries.	Brought to trip (E. PUE) if error occurs continuously more than the allowable number of retry times.
H1	Parity error	The parity check result does not match the specified parity	
H2	Sum check error	The sum check code in the computer does not match that of the data received by the inverter.	
H3	Protocol error	The data received by the inverter has a grammatical mistake. Alternatively, data receive is not completed within the predetermined time. CR or LF is not as set in the parameter.	
H4	Framing error	The stop bit length differs from the initial setting.	
H5	Overrun error	New data has been sent by the computer before the inverter completes receiving the preceding data.	
H6	—	—	—
H7	Character error	The character received is invalid (other than 0 to 9, A to F, control code).	Does not accept received data but is not brought to trip.
H8	—	—	—
H9	—	—	—
HA	Mode error	Parameter write was attempted in other than the computer link operation mode, when operation command source is not selected or during inverter operation.	Does not accept received data but is not brought to trip.
HB	Instruction code error	The specified command does not exist.	
HC	Data range error	Invalid data has been specified for parameter write, frequency setting, etc.	
HD	—	—	—
HE	—	—	—
HF	—	—	—

## (5) Response time

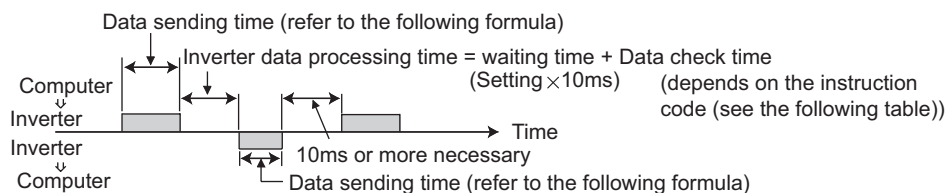

[Formula for data sending time]

$$\frac{1}{\text{Communication speed (bps)}} \times \text{Number of data characters} \times \text{Communication (Total number of bits)} = \text{data send time (s)}$$

(Refer to page 209) (Refer to the following.)

### ●Communication specifications

Name	Number of Bits
Stop bit length	1 bits
	2 bits
Data length	7 bits
	8 bits
Parity check	Present 1 bits
	Absent 0

In addition to the above, 1 start bit is necessary.  
 Minimum number of total bits ..... 9 bits  
 Maximum number of total bits ..... 12 bits

### ●Data check time

Item	Check Time
Various monitors, operation command, frequency setting (RAM)	< 12ms
Parameter read/write, frequency setting (EEPROM)	< 30ms
Parameter clear/all clear	< 5s
Reset command	No answer

## (6) Instructions for the program

- 1) When data from the computer has any error, the inverter does not accept that data. Hence, in the user program, always insert a retry program for data error.
- 2) All data communication, e.g. run command or monitoring, are started when the computer gives a communication request. The inverter does not return any data without the computer's request. Hence, design the program so that the computer gives a data read request for monitoring, etc. as required.
- 3) Program example

To change the operation mode to computer link operation

### Programming example of Microsoft® Visual C++® (Ver.6.0)

```

#include <stdio.h>
#include <windows.h>

void main(void){
    HANDLE      hCom;          //Communication handle
    DCB          hDcb;         //Structure for communication setting
    COMMTIMEOUTS hTim;        // Structure for time out setting

    char        szTx[0x10];    // Send buffer
    char        szRx[0x10];    // Receive buffer
    char        szCommand[0x10]; // Command
    int         nTx,nRx;       // For buffer size storing
    int         nSum;          // For sum code calculation
    BOOL        bRet;
    int         nRet;
    int         i;

    /***** Opens COM1 port****
    hCom = CreateFile ("COM1", (GENERIC_READ | GENERIC_WRITE), 0, NULL, OPEN_EXISTING, FILE_ATTRIBUTE_NORMAL, NULL);
    if (hCom != NULL) {
        /***** Makes a communication setting of COM1 port****
        GetCommState(hCom,&hDcb); // Retrieves current communication information
        hDcb.DCBlength = sizeof(DCB); // Structure size setting
        hDcb.BaudRate = 19200; // Communication speed=19200bps
        hDcb.ByteSize = 8; // Data length=8bit
        hDcb.Parity = 2; // Even parity
        hDcb.StopBits = 2; // Stop bit=2bit
        bRet = SetCommState(hCom,&hDcb); // Sets the changed communication data
        if (bRet == TRUE) {
            /***** Makes a time out setting of COM1 port****
            GetCommTimeouts(hCom,&hTim); // Obtains the current time out value
            hTim.WriteTotalTimeoutConstant = 1000; // Write time out 1s
            hTim.ReadTotalTimeoutConstant = 1000; // Read time out 1s
            SetCommTimeouts(hCom,&hTim); // Changed time out value setting
            /***** Sets the operation mode of the station 1 inverter to the network operation mode ****
            sprintf(szCommand,"01FB10000"); // Send data (NET operation write)
            nTx = strlen(szCommand); //Send data size
            /***** Generates sum code****
            nSum = 0; // Initialization of sum data
            for (i = 0;i < nTx;i++) {
                nSum += szCommand[i]; // Calculates sum code
                nSum &= (0xff); // Masks data
            }

            /***** Generates send data****
            memset(szTx,0,sizeof(szTx)); // Initialization of send buffer
            memset(szRx,0,sizeof(szRx)); // Initialization of receive buffer
            sprintf(szTx,"%5s%02X",szCommand,nSum); // ENQ code+send data+sum code
            nTx = 1 + nTx + 2; // Number of ENQ code+number of send data+number of sum code

            nRet = WriteFile(hCom,szTx,nTx,&nTx,NULL);
            /***** Sending ****
            if(nRet != 0) {
                nRet = ReadFile(hCom,szRx,sizeof(szRx),&nRx,NULL);
            /***** Receiving ****
            if(nRet != 0) {
                /***** Displays the receive data ****
                for(i = 0;i < nRx;i++) {
                    printf("%02X ",(BYTE)szRx[i]); // Consol output of receive data
                    // Displays ASCII coder in hexadecimal. Displays 30 when "0"
                }
                printf("\n\r");
            }
            }
            }
            CloseHandle(hCom); // Close communication port
        }
    }
}
    
```

General flowchart

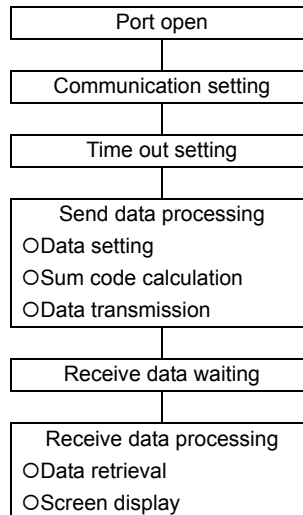

### CAUTION

 Always set the communication check time interval before starting operation to prevent hazardous conditions.

Data communication is not started automatically but is made only once when the computer provides a communication request. If communication is disabled during operation due to signal loss etc., the inverter cannot be stopped. When the communication check time interval has elapsed, the inverter will come to trip (E.PUE, E.SER).

The inverter can be coasted to a stop by switching on its RES signal or by switching power off.

 If communication is broken due to signal cable breakage, computer fault etc., the inverter does not detect such a fault. This should be fully noted.



**(7) Setting items and set data**

After completion of parameter settings, set the instruction codes and data then start communication from the computer to allow various types of operation control and monitoring.

No.	Item	Read/Write	Instruction Code	Data Definition	Number of Data Digits (Format)														
1	Operation mode	Read	H7B	H0000: Network operation H0001: External operation	4 digits (B, E/D)														
		Write	HFB	H0002: PU operation	4 digits (A, C/D)														
2	Monitor	Read	H6F	H0000 to HFFFF: Output frequency in 0.01Hz increments Speed increments 0.001 (when Pr. 37 = 0.01 to 9998) When "0.01 to 9998" is set in Pr. 37 and "01" in instruction code HFF, the data format is E". When "100" is set in Pr. 52, the monitor value is different depending on whether the inverter is at a stop or running. <i>(Refer to page 146)</i>	4 digits, 6 digits (B, E, E"/D)														
		Read	H70	H0000 to HFFFF: Output current (hexadecimal) in 0.01A increments	4 digits (B, E/D)														
		Read	H71	H0000 to HFFFF: Output voltage (hexadecimal) in 0.1V increments	4 digits (B, E/D)														
		Read	H72	H0000 to HFFFF: Monitor data selected in instruction code HF3	4 digits, 6 digits (B, E, E"/D)														
		Read	Special monitor Selection No.	H73	H01 to H3C: Monitor selection data Refer to the special monitor No. table (page 217)	2 digits (B, E"/D)													
				Write		HF3	2 digits (A', C/D)												
		Read	Fault description	H74 to H77	H0000 to HFFFF: Two latest fault definitions  <table border="1" style="margin-left: 40px;"> <tr> <td style="text-align: center;">b15</td> <td style="text-align: center;">b8b7</td> <td style="text-align: center;">b0</td> </tr> <tr> <td>H74</td> <td>First fault in past</td> <td>Latest fault</td> </tr> <tr> <td>H75</td> <td>Third fault in past</td> <td>Second fault in past</td> </tr> <tr> <td>H76</td> <td>Fifth fault in past</td> <td>Fourth fault in past</td> </tr> <tr> <td>H77</td> <td>Seventh fault in past</td> <td>Sixth fault in past</td> </tr> </table> Refer to the alarm data table (page 218)	b15	b8b7	b0	H74	First fault in past	Latest fault	H75	Third fault in past	Second fault in past	H76	Fifth fault in past	Fourth fault in past	H77	Seventh fault in past
b15	b8b7	b0																	
H74	First fault in past	Latest fault																	
H75	Third fault in past	Second fault in past																	
H76	Fifth fault in past	Fourth fault in past																	
H77	Seventh fault in past	Sixth fault in past																	
3	Run command (expansion)	Write	HF9	Control input commands such as the forward rotation signal (STF) and reverse rotation signal (STR). (For details, refer to page 219)	4 digits (A, C/D)														
	Run command	Write	HFA		2 digits (A', C/D)														
4	Inverter status monitor (expansion)	Read	H79	Monitor the states of the output signals such as forward rotation, reverse rotation and inverter running (RUN). (For details, refer to page 219)	4 digits (B, E/D)														
	Inverter status monitor	Read	H7A		2 digits (B, E"/D)														
5	Set frequency (RAM)	Read	H6D	Read set frequency/speed from RAM or EEPROM. H0000 to HFFFF: Set frequency in 0.01Hz increments Speed increments 0.001 (when Pr. 37 = 0.01 to 9998) When "0.01 to 9998" is set in Pr. 37 and "01" in instruction code HFF, the data format is E".	4 digits, 6 digits (B, E, E"/D)														
	Set frequency (EEPROM)		H6E																
	Set frequency (RAM)	Write	HED	Write set frequency/speed to RAM or EEPROM. H0000 to H9C40 (0 to 400.00Hz): Frequency increments 0.01Hz Speed increments 0.001 (when Pr. 37 = 0.01 to 9998) When "0.01 to 9998" is set in Pr. 37 and "01" in instruction code HFF, the data format is A". • To change the set frequency consecutively, write data to the inverter RAM. (instruction code: HED)	4 digits, 6 digits (A, A", C/D)														
	Set frequency (RAM, EEPROM)		HEE																

Refer to page 209 for data format (A, A', A", B, B', C, D, E, E', E")

No.	Item	Read/Write	Instruction Code	Data Definition	Number of Data Digits (Format)																									
6	Inverter reset	Write	HFD	H9696: Inverter reset • As the inverter is reset at start of communication by the computer, the inverter cannot send reply data back to the computer.	4 digits (A, C/D)																									
				H9666: Inverter reset • When data is sent normally, ACK is returned to the computer and then the inverter is reset.	4 digits (A, D)																									
7	Fault definition all clear	Write	HF4	H9696: Faults history batch clear	4 digits (A, C/D)																									
8	Parameter all clear	Write	HFC	All parameters return to the initial values. Any of four different all clear operations are performed according to the data. <table border="1" style="width: 100%; border-collapse: collapse; text-align: center;"> <thead> <tr> <th style="width: 15%;">Pr.</th> <th style="width: 15%;">Communication Pr.</th> <th style="width: 15%;">Calibration Pr. *2</th> <th style="width: 15%;">Other Pr. *3</th> <th style="width: 15%;">HEC HF3 HFF</th> </tr> </thead> <tbody> <tr> <td>H9696</td> <td>○</td> <td>×</td> <td>○</td> <td>○</td> </tr> <tr> <td>H9966</td> <td>○</td> <td>○</td> <td>○</td> <td>○</td> </tr> <tr> <td>H5A5A</td> <td>×</td> <td>×</td> <td>○</td> <td>○</td> </tr> <tr> <td>H55AA</td> <td>×</td> <td>○</td> <td>○</td> <td>○</td> </tr> </tbody> </table> When all parameter clear is executed for H9696 or H9966, communication-related parameter settings also return to the initial values. When resuming operation, set the parameters again. *1 Refer to page 203. *2 Refer to the list of calibration parameters below for calibration parameters. *3 Pr. 75 is not cleared.	Pr.	Communication Pr.	Calibration Pr. *2	Other Pr. *3	HEC HF3 HFF	H9696	○	×	○	○	H9966	○	○	○	○	H5A5A	×	×	○	○	H55AA	×	○	○	○	4 digits (A, C/D)
				Pr.	Communication Pr.	Calibration Pr. *2	Other Pr. *3	HEC HF3 HFF																						
H9696	○	×	○	○																										
H9966	○	○	○	○																										
H5A5A	×	×	○	○																										
H55AA	×	○	○	○																										
9	Parameter	Read	H00 to H63	Refer to the instruction code (Refer to page 54) and write and/or read parameter values as required.	4 digits, 6 digits (B, E, E'/D)																									
10		Write	H80 to HE3	When setting Pr. 100 and later, link parameter extended setting must be set. Data format of Pr. 37 read and write is E" and A"	4 digits, 6 digits (A, A", C/D)																									
11	Link parameter expansion setting	Read	H7F	Parameter description is changed according to the H00 to H09 setting.	2 digits (B, E'/D)																									
		Write	HFF	For details of the settings, refer to the parameter instruction code (Refer to page 54).	2 digits (A', C/D)																									
12	Second parameter changing (instruction code HFF = 1, 9)	Read	H6C	Setting calibration parameter *1 H00: Frequency *2 H01: Parameter-set analog value H02: Analog value input from terminal	2 digits (B, E'/D)																									
		Write	HEC	*1 Refer to the list of calibration parameters on the next page for calibration parameters. *2 The gain frequency can also be written using Pr. 125 (instruction code: H99) or Pr. 126 (instruction code: H9A).	2 digits (A', C/D)																									

Refer to page 209 for data format (A, A', A", B, B', C, D, E, E', E")



**REMARKS**

- Set 65520 (HFFF0) as a parameter value "8888" and 65535 (HFFFF) as "9999".
- For the instruction codes HFF, HEC and HF3, their values are held once written but cleared to zero when an inverter reset or all clear is performed.

Example) When reading the C3 (Pr. 902) and C6 (Pr. 904) settings from the inverter of station 0

	Computer Send Data	Inverter Send Data	Description
1)	ENQ 00 FF 0 01 82	ACK 00	Set "H01" to the expansion link parameter.
2)	ENQ 00 EC 0 01 7E	ACK 00	Set "H01" to second parameter changing.
3)	ENQ 00 5E 0 0F	STX 00 0000 ETX 25	C3 (Pr. 902) is read. 0% is read.
4)	ENQ 00 60 0 FB	STX 00 0000 ETX 25	C6 (Pr. 904) is read. 0% is read.

To read/write C3 (Pr. 902) and C6 (Pr. 904) after inverter reset or parameter clear, execute from 1) again.

● List of calibration parameters

Parameter	Name	Instruction Code		
		Read	Write	Extended
C2 (902)	Terminal 2 frequency setting bias frequency	5E	DE	1
C3 (902)	Terminal 2 frequency setting bias	5E	DE	1
125 (903)	Terminal 2 frequency setting gain frequency	5F	DF	1
C4 (903)	Terminal 2 frequency setting gain	5F	DF	1
C5 (904)	Terminal 4 frequency setting bias frequency	60	E0	1
C6 (904)	Terminal 4 frequency setting bias	60	E0	1
126 (905)	Terminal 4 frequency setting gain frequency	61	E1	1
C7 (905)	Terminal 4 frequency setting gain	61	E1	1

[Special monitor selection No.]

Refer to page 146 for details of the monitor description.

Data	Description	Unit
H01	Output frequency/speed *1	0.01Hz/ 0.001
H02	Output current	0.01A
H03	Output voltage	0.1V
H05	Frequency setting/speed setting *1	0.01Hz/ 0.001
H07	Motor torque	0.1%
H08	Converter output voltage	0.1V
H09	Regenerative brake duty	0.1%
H0A	Electronic thermal relay function load factor	0.1%
H0B	Output current peak value	0.01A
H0C	Converter output voltage peak value	0.1V
H0E	Output power	0.01kW

Data	Description	Unit
H0F	Input terminal status *2	—
H10	Output terminal status *3	—
H14	Cumulative energization time	1h
H17	Actual operation time	1h
H18	Motor load factor	0.1%
H19	Cumulative power	1kWh
H34	PID set point	0.1%
H35	PID measured value	0.1%
H36	PID deviation	0.1%
H3A	Option input terminal status 1*4	—
H3B	Option input terminal status 2*5	—
H3C	Option output terminal status *6	—
H3D	Motor thermal load factor	0.1%
H3E	Inverter thermal load factor	0.1%

\*1 When "0.01 to 9998" is set in Pr. 37 and "01" in instruction code HFF, the data format is 6 digits (E").

\*2 Input terminal monitor details

b15														b0	
—	—	—	—	—	RES	—	MRS	—	RH	RM	RL	—	—	STR	STF

\*3 Output terminal monitor details

b15														b0		
—	—	—	—	—	—	—	—	—	—	—	ABC	FU	—	—	—	RUN

\*4 Details of option input terminal monitor 1 (input terminal status of FR-A7AX E kit)—all terminals are off when an option is not fitted.

b15														b0	
X15	X14	X13	X12	X11	X10	X9	X8	X7	X6	X5	X4	X3	X2	X1	X0

\*5 Details of option input terminal monitor 2 (input terminal status of FR-A7AX E kit)—all terminals are off when an option is not fitted.

b15														b0		
—	—	—	—	—	—	—	—	—	—	—	—	—	—	—	—	DY

\*6 Details of option output terminal monitor (output terminal status of FR-A7AX E kit/A7AR E kit)—all terminals are off when an option is not fitted.

b15														b0	
—	—	—	—	—	—	RA3	RA2	RA1	Y6	Y5	Y4	Y3	Y2	Y1	Y0

## [Fault data]

Refer to page 271 for details of fault description

Data	Definition
H00	No fault present
H10	E.OC1
H11	E.OC2
H12	E.OC3
H20	E.OV1
H21	E.OV2
H22	E.OV3
H30	E.THT
H31	E.THM
H40	E.FIN
H52	E.ILF

Data	Definition
H60	E.OLT
H70	E.BE
H80	E.GF
H81	E.LF
H90	E.OHT
HA1	E.OP1
HB0	E.PE
HB1	E.PUE
HB2	E.RET
HB3	E.PE2
HC0	E.CPU
HC5	E.IOH

Data	Definition
HC7	E.AIE
HC8	E.USB
HD8	E.MB4
HD9	E.MB5
HDA	E.MB6
HDB	E.MB7
HF1	E.1
HF6	E.6
HF7	E.7
HFD	E.13

### Fault definition display example (instruction code H74)

For read data H30A0  
 (Previous fault ..... THT)  
 (Latest fault...OPT)

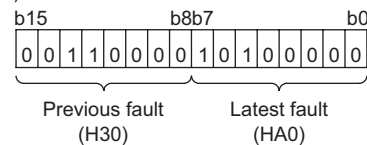

[Run command]

Item	Instruction Code	Bit Length	Description	Example
Run command	HFA	8bit	b0: AU (current input selection) *3 b1: forward rotation command b2: reverse rotation command b3: RL (low speed operation command) *1*3 b4: RM (middle speed operation command) *1*3 b5: RH (high speed operation command) *1*3 b6: RT (second function selection)*3 b7: MRS (output stop) *1*3	[Example 1] H02... Forward rotation b7 b0 0 0 0 0 0 0 1 0 [Example 2] H00... Stop b7 b0 0 0 0 0 0 0 0 0
Run command (expansion)	HF9	16bit	b0: AU (current input selection) *3 b1: forward rotation command b2: reverse rotation command b3: RL (low speed operation command) *1*3 b4: RM (middle speed operation command) *1*3 b5: RH (high speed operation command) *1*3 b6: RT (second function selection)*3 b7: MRS (output stop) *1*3 b8: — b9: — b10: — b11: RES (reset) *2*3 b12: — b13: — b14: — b15: —	[Example 1] H0002... Forward rotation b15 b0 0 0 0 0 0 0 0 0 0 0 0 0 0 0 1 0 [Example 2] H0800... Low speed operation (When Pr. 184 RES terminal function selection is set to "0") b15 b0 0 0 0 0 1 0 0 0 0 0 0 0 0 0 0 0

- \*1 The signal within parentheses is the default setting. The description changes depending on the setting of Pr. 180 to Pr. 184 (input terminal function selection) (page 131).
- \*2 The signal within parentheses is the default setting. Reset cannot be controlled by the network, bit 11 is invalid in the initial status. When using bit 11, change the signal with Pr. 184 RES terminal function selection (page131) (Reset can be executed with the instruction code HFD)
- \*3 When Pr. 551 = "2" (PU Mode control source is PU connector), only forward rotation and reverse rotation can be used.

[Inverter status monitor]

Item	Instruction Code	Bit Length	Description	Example
Inverter status monitor	H7A	8bit	b0: RUN (inverter running) * b1: Forward rotation b2: Reverse rotation b3: SU (up-to-frequency) b4: OL (overload) b5: — b6: FU (frequency detection) * b7: ABC (fault) *	[Example 1] H02... During forward rotation b7 b0 0 0 0 0 0 0 1 0 [Example 2] H80... Stop at fault occurrence b7 b0 0 0 0 0 0 0 1 0
Inverter status monitor (expansion)	H79	16bit	b0: RUN (inverter running) * b1: Forward rotation b2: Reverse rotation b3: SU (up-to-frequency) b4: OL (overload) b5: — b6: FU (frequency detection) * b7: ABC (fault) * b8: — b9: — b10: — b11: — b12: — b13: — b14: — b15: Fault occurrence	[Example 1] H0002... During forward rotation b15 b0 0 0 0 0 0 0 0 0 0 0 0 0 0 0 1 0 [Example 2] H8080... Stop at fault occurrence b15 b0 1 0 0 0 0 0 0 0 1 0 0 0 0 0 0 0

\* The signal within parentheses is the default setting. Definitions change according to the Pr.190 to Pr. 192 (output terminal function selection).

### 4.2.0.6 Modbus RTU communication specifications

(Pr. 117, Pr. 118, Pr. 120, Pr. 122, Pr. 343, Pr. 502, Pr. 549)

Using the Modbus RTU communication protocol, communication operation or parameter setting can be performed from the PU connector of the inverter.

Parameter Number	Name	Initial Value	Setting Range	Description			
117	PU communication station number	0	0	Broadcast communication			
			1 to 247	Inverter station number specification Set the inverter station numbers when two or more inverters are connected to one personal computer.			
118	PU communication speed	96	48, 96, 192, 384	Communication speed The setting value × 100 equals the communication speed. Example) 9600bps if 96			
120	RS-485 communication parity check selection	2	0	Without parity check Stop bit length 2bit			
			1	With odd parity check Stop bit length 1bit			
			2	With even parity check Stop bit length 1bit			
122	PU communication check time interval	0	0	RS-485 communication can be made. Note that a communication fault (E.PUE) occurs as soon as the inverter is switched to the operation mode with command source.			
			0.1 to 999.8s	Communication check (signal loss detection) time interval If a no-communication state persists for longer than the permissible time, the inverter will come to trip (depends on Pr. 502).			
			9999	No communication check (signal loss detection)			
343	Communication error count	0	—	Displays the number of communication errors during Modbus-RTU communication (reading only)			
502	Stop mode selection at communication error	0	0, 3	<b>At Fault Occurrence</b>	<b>Indication</b>	<b>Fault Output</b>	<b>At Fault Removal</b>
				Coasts to stop.	E.PUE	Output	Stop (E.PUE)
				1	Decelerates to stop	After stop E.PUE	Output after stop
2	Decelerates to stop	After stop E.PUE	Without output	Automatic restart functions			
549	Protocol selection	0	0	Mitsubishi inverter (computer link operation) protocol			
			1	Modbus-RTU protocol			

The above parameters can be set when Pr. 160 User group read selection = "0". (Refer to page 180)



#### NOTE

- When Modbus-RTU communication is performed from the master with address 0 (station number 0) set, broadcast communication is selected and the inverter does not send a response message. When response from the inverter is necessary, set a value other than "0" (initial value is 0) in Pr. 117 PU communication station number.  
Some functions are invalid for broadcast communication. (Refer to page 223)
- When "1" (Modbus-RTU protocol) is set in Pr. 549 and "384" (38400bps) in Pr. 118, parameter unit (FR-PU04/FR-PU07) is disabled. When using the parameter unit (FR-PU04/FR-PU07), change parameter using the operation panel.



#### REMARKS

- Set Pr. 549 Protocol selection to "1" to use the Modbus RTU protocol.
- When PU connector is selected as NET mode operation source (when Pr. 550 NET mode operation command source selection = "2" or "9999" (initial value) without communication option), Modbus RTU communication operation can be performed. (Refer to page 194)

**(1) Communication**

•The communication specifications are given below.

Item	Description	Related Parameter	
Communication protocol	Modbus-RTU protocol	Pr. 549	
Conforming standard	EIA-485(RS-485)	—	
Number of connectable devices	1:N (maximum 32 units), setting is 0 to 247 stations	Pr. 117	
Communication speed	Selected from among 4800/9600/19200 and 38400bps	Pr. 118	
Control procedure	Asynchronous	—	
Communication method	Half-duplex	—	
Communi- cation	Character system	Binary (always 8 bits)	
	Start bit	1bit	
	Stop bit length	Select from the following three types •No parity, stop bit length 2 bits •No odd parity, stop bit length 1 bits •Even parity, stop bit length 1 bit	Pr. 120
	Parity check		
	Error check	CRC code check	—
	Terminator	Not used	—
Waiting time setting	Not used	—	

**(2) Outline**

The Modbus protocol is the communication protocol developed by Modicon for PLC.

The Modbus protocol performs serial communication between the master and slave using the dedicated message frame. The dedicated message frame has the functions that can perform data read and write. Using the functions, you can read and write the parameter values from the inverter, write the input command of the inverter, and check the operating status. In this product, the inverter data are classified in the holding register area (register addresses 40001 to 49999). By accessing the assigned holding register address, the master can communicate with the inverter which is a slave.



**REMARKS**

There are two different serial transmission modes: ASCII (American Standard Code for Information Interchange) mode and RTU (Remote Terminal Unit) mode. This product supports only the RTU mode in which 1-byte (8-bit) data is transmitted as-is. Only the communication protocol is defined by the Modbus protocol, and the physical layer is not stipulated.

## (3) Message format

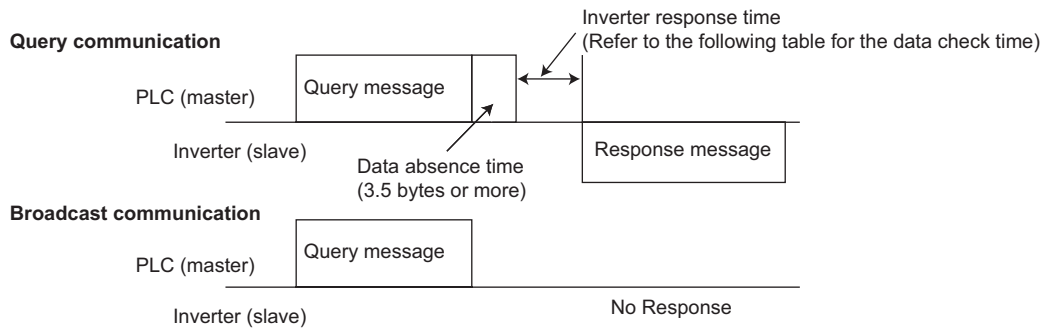

### ●Data check time

Item	Check Time
Various monitors, operation command, frequency setting (RAM)	<12ms
Parameter read/write, frequency setting (EEPROM)	<30ms
Parameter clear/all clear	<5s
Reset command	No answer

### 1) Query

The master sends a message to the slave (= inverter) at the specified address.

### 2) Normal Response

After receiving the query from the master, the slave executes the requested function and returns the corresponding normal response to the master.

### 3) Error Response

If an invalid function code, address or data is received, the slave returns it to the master.

When a response description is returned, the error code indicating that the request from the master cannot be executed is added.

No response is returned for the hardware-detected error, frame error and CRC check error.

### 4) Broadcast

By specifying address 0, the master can send a message to all slaves. All slaves that received the message from the master execute the requested function. In this communication, the slaves do not return a response to the master.



### REMARKS

The slave executes the function independently of the inverter station number setting (*Pr. 117*) during broadcast communication.



**(4) Message frame (protocol)**

●Communication method

Basically, the master sends a query message (question) and the slave returns a response message (response). When communication is normal, Device Address and Function Code are copied as they are, and when communication is abnormal (function code or data code is illegal), bit 7 (= 80h) of Function Code is turned on and the error code is set to Data Bytes.

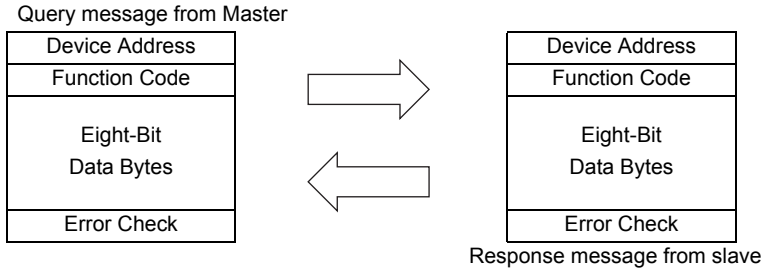

The message frame consists of the four message fields as shown above.

By adding the no-data time (T1: Start, End) of 3.5 characters to the beginning and end of the message data, the slave recognizes it as one message.

●Protocol details

The four message fields will be explained below.

Start	1) ADDRESS	2) FUNCTION	3) DATA	4) CRC CHECK		End
T1	8bit	8bit	n×8bit	L 8bit	H 8bit	T1

Message Field	Description																								
1) ADDRESS field	The address code is 1 byte long (8 bits) and any of 0 to 247 can be set. Set 0 to send a broadcast message (all-address instruction) or any of 1 to 247 to send a message to each slave. When the slave responds, it returns the address set from the master. The value set to <i>Pr. 117 PU communication station number</i> is the slave address.																								
2) FUNCTION field	<p>The function code is 1 byte long (8 bits) and any of 1 to 255 can be set. The master sets the function that it wants to request from the slave, and the slave performs the requested operation. The following table gives the supported function codes. An error response is returned if the set function code is other than those in the following table.</p> <p>When the slave returns a normal response, it returns the function code set by the master. When the slave returns an error response, it returns H80 + function code.</p> <table border="1"> <thead> <tr> <th>Code</th> <th>Function Name</th> <th>Outline</th> <th>Broadcast Communication</th> </tr> </thead> <tbody> <tr> <td>H03</td> <td>Read Holding Register</td> <td>Reads the holding register data.</td> <td>Disallowed</td> </tr> <tr> <td>H06</td> <td>Preset Single Register</td> <td>Writes data to the holding register.</td> <td>Allowed</td> </tr> <tr> <td>H08</td> <td>Diagnostics</td> <td>Function diagnosis (communication check only)</td> <td>Disallowed</td> </tr> <tr> <td>H10</td> <td>Preset Multiple Registers</td> <td>Writes data to multiple consecutive holding registers.</td> <td>Allowed</td> </tr> <tr> <td>H46</td> <td>Read Holding Register Access Log</td> <td>Reads the number of registers that succeeded in communication last time.</td> <td>Disallowed</td> </tr> </tbody> </table> <p style="text-align: center;"><b>Table 1:Function code list</b></p>	Code	Function Name	Outline	Broadcast Communication	H03	Read Holding Register	Reads the holding register data.	Disallowed	H06	Preset Single Register	Writes data to the holding register.	Allowed	H08	Diagnostics	Function diagnosis (communication check only)	Disallowed	H10	Preset Multiple Registers	Writes data to multiple consecutive holding registers.	Allowed	H46	Read Holding Register Access Log	Reads the number of registers that succeeded in communication last time.	Disallowed
Code	Function Name	Outline	Broadcast Communication																						
H03	Read Holding Register	Reads the holding register data.	Disallowed																						
H06	Preset Single Register	Writes data to the holding register.	Allowed																						
H08	Diagnostics	Function diagnosis (communication check only)	Disallowed																						
H10	Preset Multiple Registers	Writes data to multiple consecutive holding registers.	Allowed																						
H46	Read Holding Register Access Log	Reads the number of registers that succeeded in communication last time.	Disallowed																						
3) DATA field	The format changes depending on the function code ( <i>Refer to page 224</i> ). Data includes the byte count, number of bytes, description of access to the holding register, etc.																								
4) CRC CHECK field	<p>The received message frame is checked for error. CRC check is performed, and 2 byte long data is added to the end of the message. When CRC is added to the message, the low-order byte is added first and is followed by the high-order byte.</p> <p>The CRC value is calculated by the sending side that adds CRC to the message. The receiving side recalculates CRC during message receiving, and compares the result of that calculation and the actual value received in the CRC CHECK field. If these two values do not match, the result is defined as error.</p>																								

## (5) Message format types

The message formats corresponding to the function codes in Table 1 on page 223 will be explained.

### ●Read holding register data (H03 or 03)

Can read the description of **1)** system environment variables, **2)** real-time monitor, **3)** faults history, and **4)** inverter parameters assigned to the holding register area (refer to the register list (page 229))

Query message

1) Slave Address	2) Function	Starting Address		No. of Points		CRC Check	
(8bit)	H03 (8bit)	H (8bit)	L (8bit)	H (8bit)	L (8bit)	L (8bit)	H (8bit)

Normal response (Response message)

1) Slave Address	2) Function	Byte Count	Data			CRC Check	
(8bit)	H03 (8bit)	(8bit)	H (8bit)	L (8bit)	... (n × 16bit)	L (8bit)	H (8bit)

### •Query message setting

Message	Setting Description
1) Slave Address	Address to which the message will be sent Broadcast communication cannot be made (0 is invalid).
2) Function	Set H03.
3) Starting Address	Set the address at which holding register data read will be started. Starting address = Starting register address (decimal)-40001 For example, setting of the starting address 0001 reads the data of the holding register 40002.
4) No. of Points	Number of holding registers from which data will be read The number of registers from which data can be read is a maximum of 125.

### •Description of normal response

Message	Setting Description
5) Byte Count	The setting range is H02 to H14 (2 to 20). Twice greater than the No. of Point specified at 4) is set.
6) Data: Read data	The number of data specified at 4) is set. Data are read in order of Hi byte and Lo byte, and set in order of starting address data, starting address + 1 data, starting address + 2 data,

Example: To read the register values of 41004 (Pr. 4) to 41006 (Pr. 6) from the slave address 17 (H11)

Query message

Slave Address	Function	Starting Address		No. of Points		CRC Check	
H11 (8bit)	H03 (8bit)	H03 (8bit)	HEB (8bit)	H00 (8bit)	H03 (8bit)	H77 (8bit)	H2B (8bit)

Normal response (Response message)

Slave Address	Function	Byte Count	Data						CRC Check	
H11 (8bit)	H03 (8bit)	H06 (8bit)	H17 (8bit)	H70 (8bit)	H0B (8bit)	HB8 (8bit)	H03 (8bit)	HE8 (8bit)	H2C (8bit)	HE6 (8bit)

Read value

Register 41004(Pr. 4): H1770 (60.00Hz)

Register 41005(Pr. 5): H0BB8 (30.00Hz)

Register 41006(Pr. 6): H03E8 (10.00Hz)

● **Write holding register data (H06 or 06)**

Can write the description of 1) system environment variables and 4) inverter parameters assigned to the holding register area (refer to the register list (page 229)).

Query message

1) Slave Address	2) Function	3) Register Address		4) Preset Data		CRC Check	
(8bit)	H06 (8bit)	H (8bit)	L (8bit)	H (8bit)	L (8bit)	L (8bit)	H (8bit)

Normal response (Response message)

1) Slave Address	2) Function	3) Register Address		4) Preset Data		CRC Check	
(8bit)	H06 (8bit)	H (8bit)	L (8bit)	H (8bit)	L (8bit)	L (8bit)	H (8bit)

• **Query message setting**

Message	Setting Description
1) Slave Address	Address to which the message will be sent Setting of address 0 enables broadcast communication
2) Function	Set H06.
3) Register Address	Address of the holding register to which data will be written Register address = Holding register address (decimal)-40001 For example, setting of register address 0001 writes data to the holding register address 40002.
4) Preset Data	Data that will be written to the holding register The written data is always 2 bytes.

• **Description of normal response**

1) to 4) (including CRC check) of the normal response are the same as those of the query message.

No response is made for broadcast communication.

Example: To write 60Hz (H1770) to 40014 (running frequency RAM) at slave address 5 (H05).

Query message

Slave Address	Function	Register Address		Preset Data		CRC Check	
H05 (8bit)	H06 (8bit)	H00 (8bit)	H0D (8bit)	H17 (8bit)	H70 (8bit)	H17 (8bit)	H99 (8bit)

Normal response (Response message)

Same data as the query message



**NOTE**

For broadcast communication, no response is returned in reply to a query. Therefore, the next query must be made when the inverter processing time has elapsed after the previous query.

## ● Function diagnosis (H08 or 08)

A communication check can be made since the query message sent is returned unchanged as a response message (function of sub function code H00).

Sub function code H00 (Return Query Data)

Query message

1) Slave Address	2) Function	3) Subfunction		4) Date		CRC Check	
(8bit)	H08 (8bit)	H00 (8bit)	H00 (8bit)	H (8bit)	L (8bit)	L (8bit)	H (8bit)

Normal response (Response message)

1) Slave Address	2) Function	3) Subfunction		4) Date		CRC Check	
(8bit)	H08 (8bit)	H00 (8bit)	H00 (8bit)	H (8bit)	L (8bit)	L (8bit)	H (8bit)

## ● Query message setting

Message	Setting Description
1) Slave Address	Address to which the message will be sent Broadcast communication cannot be made (0 is invalid).
2) Function	Set H08.
3) Subfunction	Set H0000.
4) Data	Any data can be set if it is 2 bytes long. The setting range is H0000 to HFFFF

## ● Description of normal response

1) to 4) (including CRC check) of the normal response are the same as those of the query message.



### NOTE

For broadcast communication, no response is returned in reply to a query. Therefore, the next query must be made when the inverter processing time has elapsed after the previous query.

## ● Write multiple holding register data (H10 or 16)

You can write data to multiple holding registers.

Query message

1) Slave Address	2) Function	3) Starting Address		4) No. of Registers		5) Byte Count	6) Data			CRC Check		
(8bit)	H10 (8bit)	H (8bit)	L (8bit)	H (8bit)	L (8bit)	(8bit)	H (8bit)	L (8bit)	...	(n×2×8bit)	L (8bit)	H (8bit)

Normal response (Response message)

1) Slave Address	2) Function	3) Starting Address	4) No. of Registers		CRC Check		
(8bit)	H10 (8bit)	H (8bit)	L (8bit)	H (8bit)	L (8bit)	L (8bit)	H (8bit)

## ● Query message setting

Message	Setting Description
1) Slave Address	Address to which the message will be sent Setting of address 0 enables broadcast communication
2) Function	Set H10.
3) Starting Address	Address where holding register data write will be started Starting address = Starting register address (decimal)-40001 For example, setting of the starting address 0001 reads the data of the holding register 40002.
4) No. of Points	Number of holding registers where data will be written The number of registers where data can be written is a maximum of 125.
5) Byte Count	The setting range is H02 to HFA (0 to 250). Set a value twice greater than the value specified at 4).
6) Data	Set the data specified by the number specified at 4). The written data are set in order of Hi byte and Lo byte, and arranged in order of the starting address data, starting address + 1 data, starting address + 2 data

• **Description of normal response**

1) to 4) (including CRC check) of the normal response are the same as those of the query message.

Example: To write 0.5s (H05) to 41007 (Pr: 7) at the slave address 25 (H19) and 1s (H0A) to 41008 (Pr:8).

Query message

Slave Address	Function	Starting Address		No. of Points		Byte Count	Data				CRC Check	
							H00	H05	H00	H0A	H86	H3D
H19 (8bit)	H10 (8bit)	H03 (8bit)	HEE (8bit)	H00 (8bit)	H02 (8bit)	H04 (8bit)	H00 (8bit)	H05 (8bit)	H00 (8bit)	H0A (8bit)	H86 (8bit)	H3D (8bit)

Normal response (Response message)

Slave Address	Function	Starting Address		No. of Points		CRC Check	
						H22	H61
H19 (8bit)	H10 (8bit)	H03 (8bit)	HEE (8bit)	H00 (8bit)	H02 (8bit)	H22 (8bit)	H61 (8bit)

● **Read holding register access log (H46 or 70)**

A response can be made to a query made by the function code H03 or H10.

The starting address of the holding registers that succeeded in access during previous communication and the number of successful registers are returned.

In response to the query for other than the above function code, 0 is returned for the address and number of registers.

Query message

1) Slave Address	2) Function	CRC Check	
(8bit)	H46 (8bit)	L (8bit)	H (8bit)

Normal response (Response message)

1) Slave Address	2) Function	3) Starting Address		4) No. of Points		CRC Check	
(8bit)	H46 (8bit)	H (8bit)	L (8bit)	H (8bit)	L (8bit)	L (8bit)	H (8bit)

• **Query message setting**

Message	Setting Description
1) Slave Address	Address to which the message will be sent Broadcast communication cannot be made (0 is invalid).
2) Function	Set H46.

• **Description of normal response**

Message	Setting Description
3) Starting Address	The starting address of the holding registers that succeeded in access is returned. Starting address = Starting register address (decimal)-40001 For example, when the starting address 0001 is returned, the address of the holding register that succeeded in access is 40002.
4) No. of Points	The number of holding registers that succeeded in access is returned.

Example: To read the successful register starting address and successful count from the slave address 25 (H19).

Query message

Slave Address	Function	CRC Check	
H19 (8bit)	H46 (8bit)	H8B (8bit)	HD2 (8bit)

Normal response (Response message)

Slave Address	Function	Starting Address		No. of Points		CRC Check	
H19 (8bit)	H10 (8bit)	H03 (8bit)	HEE (8bit)	H00 (8bit)	H02 (8bit)	H22 (8bit)	H61 (8bit)

Success of two registers at starting address 41007 (Pr: 7) is returned.

## ● Error response

An error response is returned if the query message received from the master has an illegal function, address or data. No response is returned for a parity, CRC, overrun, framing or busy error.



### NOTE

No response message is sent in the case of broadcast communication also.

Error response (Response message)

1) Slave Address	2) Function	3) Exception Code	CRC Check	
(8bit)	H80 + Function (8bit)	(8bit)	L (8bit)	H (8bit)

Message	Setting Description
1) Slave Address	Address received from the master
2) Function	Master-requested function code + H80
3) Exception Code	Code in the following table

### Error code list

Code	Error Item	Error Description
01	ILLEGAL FUNCTION (Function code illegal)	The set function code in the query message from the master cannot be handled by the slave.
02	ILLEGAL DATA ADDRESS *1 (Address illegal)	The set register address in the query message from the master cannot be handled by the inverter. (No parameter, parameter read disabled, parameter write disabled)
03	ILLEGAL DATA VALUE (Data illegal)	The set data in the query message from the master cannot be handled by the inverter. (Out of parameter write range, mode specified, other error)

\*1 An error will not occur in the following cases.

- 1) Function code H03 (Read holding register data)

When the No. of Points is 1 or more and there is one or more holding registers from which data can be read

- 2) Function code H10 (Write multiple holding register data)

When the No. of Points is 1 or more and there is 1 or more holding registers to which data can be written

Namely, when the function code H03 or H10 is used to access multiple holding registers, an error will not occur if a non-existing holding register or read disabled or write disabled holding register is accessed.



### REMARKS

An error will occur if all accessed holding registers do not exist.

Data read from a non-existing holding register is 0, and data written there is invalid.

## ● Message data mistake detection

To detect the mistakes of message data from the master, they are checked for the following errors.

If an error is detected, a trip will not occur.

### Error check item

Error Item	Error Description	Inverter Operation
Parity error	The data received by the inverter differs from the specified parity (Pr. 334 setting).	1) Pr.343 is increased by 1 at error occurrence. 2)The terminal LF is output at error occurrence.
Framing error	The data received by the inverter differs from the specified stop bit length (Pr. 333).	
Overrun error	The following data was sent from the master before the inverter completes data receiving.	
Message frame error	The message frame data length is checked, and the received data length of less than 4 bytes is regarded as an error.	
CRC check error	A mismatch found by CRC check between the message frame data and calculation result is regarded as an error.	

(6) Modbus registers

● System environment variable

Register	Definition	Read/write	Remarks
40002	Inverter reset	Write	Any value can be written
40003	Parameter clear	Write	Set H965A as a written value.
40004	All Parameter clear	Write	Set H99AA as a written value.
40006	Parameter clear *1	Write	Set H5A96 as a written value.
40007	All parameter clear *1	Write	Set HAA99 as a written value.
40009	Inverter status/control input instruction*2	Read/write	See below.
40010	Operation mode/inverter setting *3	Read/write	See below.
40014	Running frequency (RAM value)	Read/write	According to the Pr.37 settings, the frequency and selectable speed are in 1r/min increments.
40015	Running frequency (EEPROM value)	Write	

- \*1 The communication parameter values are not cleared.
- \*2 For write, set the data as a control input instruction.  
For read, data is read as an inverter operating status.
- \*3 For write, set data as the operation mode setting.  
For read, data is read as the operation mode status.

<Inverter status/control input instruction>

Bit	Definition	
	Control input instruction	Inverter status
0	Stop command	RUN (inverter running) *2
1	Forward rotation command	Forward rotation
2	Reverse rotation command	During reverse rotation
3	RH (high-speed operation command)*1	SU (up-to-frequency)
4	RM (middle-speed operation command)*1	OL (overload)
5	RL (low-speed operation command)*1	0
6	0	FU (frequency detection) *2
7	RT (second function selection)	ABC (fault) *2
8	AU (current input selection)	0
9	0	0
10	MRS (output stop) *1	0
11	0	0
12	RES (reset) *1	0
13	0	0
14	0	0
15	0	Fault occurrence

<Operation mode/inverter setting>

Mode	Read Value	Written Value
EXT	H0000	H0010
PU	H0001	—
EXT JOG	H0002	—
PU JOG	H0003	—
NET	H0004	H0014
PUEXT	H0005	—

The restrictions depending on the operation mode changes according to the computer link specifications.

- \*1 The signal within parentheses is the default setting. The description changes depending on the setting of Pr.180 to Pr.184 (input terminal function selection) (refer to page 131).  
Each assigned signal is valid or invalid depending on NET. (Refer to page 194)
- \*2 The signal within parentheses is the default setting. Definitions change according to the Pr.190 to Pr.192 (output terminal function selection) (refer to page 137).

● Real time monitor

Refer to page 146 for details of the monitor description.

Register	Description	Unit
40201	Output frequency/speed *1	0.01Hz/1
40202	Output current	0.01A
40203	Output voltage	0.1V
40205	Output frequency setting/speed setting *1	0.01Hz/ 0.001
40207	Motor torque	0.1%
40208	Converter output voltage	0.1V
40209	Regenerative brake duty	0.1%
40210	Electronic thermal relay function load factor	0.1%
40211	Output current peak value	0.01A
40212	Converter output voltage peak value	0.1V
40214	Output power	0.01kW
40215	Input terminal status *2	—

Register	Description	Unit
40216	Output terminal status *3	—
40220	Cumulative energization time	1h
40223	Actual operation time	1h
40224	Motor load factor	0.1%
40225	Cumulative power	1kWh
40252	PID set point	0.1%
40253	PID measured value	0.1%
40254	PID deviation	0.1%
40258	Option input terminal status*4	—
40259	Option input terminal status 2*5	—
40260	Option output terminal status *6	—
40261	Motor thermal load factor	0.1%
40262	Inverter thermal load factor	0.1%

\*1 When "0.01 to 9998" is set in *Pr.37* and "01" in instruction code HFF, the data format is 6 digits (E").

\*2 Input terminal monitor details

b15

b0

—	—	—	—	—	RES	—	MRS	—	RH	RM	RL	—	—	STR	STF
---	---	---	---	---	-----	---	-----	---	----	----	----	---	---	-----	-----

\*3 Output terminal monitor details

b15

b0

—	—	—	—	—	—	—	—	—	—	—	ABC	FU	—	—	—	RUN
---	---	---	---	---	---	---	---	---	---	---	-----	----	---	---	---	-----

\*4 Details of option input terminal monitor 1 (input terminal status of FR-A7AX E kit)—all terminals are off when an option is not fitted.

b15

b0

X15	X14	X13	X12	X11	X10	X9	X8	X7	X6	X5	X4	X3	X2	X1	X0
-----	-----	-----	-----	-----	-----	----	----	----	----	----	----	----	----	----	----

\*5 Details of option input terminal monitor 2 (input terminal status of FR-A7AX E kit)—all terminals are off when an option is not fitted.

b15

b0

—	—	—	—	—	—	—	—	—	—	—	—	—	—	—	DY
---	---	---	---	---	---	---	---	---	---	---	---	---	---	---	----

\*6 Details of option output terminal monitor (output terminal status of FR-A7AY E kit/A7AR E kit)—all terminals are off when an option is not fitted.

b15

b0

—	—	—	—	—	—	RA3	RA2	RA1	Y6	Y5	Y4	Y3	Y2	Y1	Y0
---	---	---	---	---	---	-----	-----	-----	----	----	----	----	----	----	----



## ● Parameter

Parameter	Register	Parameter Name	Read/Write	Remarks
0 to 999	41000 to 41999	Refer to the parameter list (page 54) for the parameter names.	Read/write	The parameter number + 41000 is the register number.
C2(902)	41902	Terminal 2 frequency setting bias frequency	Read/write	
C3(902)	42092	Terminal 2 frequency setting bias (Analog value)	Read/write	The analog value (%) set to C3 (902) is read.
	43902	Terminal 2 frequency setting bias (Terminal analog value)	Read	The analog value (%) of the voltage (current) applied to the terminal 2 is read.
125(903)	41903	Terminal 2 frequency setting gain frequency	Read/write	
C4(903)	42093	Terminal 2 frequency setting gain (Analog value)	Read/write	The analog value (%) set to C4 (903) is read.
	43903	Terminal 2 frequency setting gain (Terminal analog value)	Read	The analog value (%) of the voltage (current) applied to the terminal 2 is read.
C5(904)	41904	Terminal 4 frequency setting bias frequency	Read/write	
C6(904)	42094	Terminal 4 frequency setting bias (Analog value)	Read/write	The analog value (%) set to C6 (904) is read.
	43904	Terminal 4 frequency setting bias (Terminal analog value)	Read	The analog value (%) of the current (voltage) applied to the terminal 4 is read.
126(905)	41905	Terminal 4 frequency setting gain frequency	Read/write	
C7(905)	42095	Terminal 4 frequency setting gain (Analog value)	Read/write	The analog value (%) set to C7 (905) is read.
	43905	Terminal 4 frequency setting gain (Terminal analog value)	Read	The analog value (%) of the current (voltage) applied to the terminal 4 is read.

## ● Faults history

Register	Definition	Read/write	Remarks
40501	Fault history 1	Read/write	Being 2 bytes in length, the data is stored as "H0000". The error code can be referred to in the low-order 1 byte. Performing write using the register 40501 batch-clears the faults history. Set any value as data.
40502	Fault history 2	Read	
40503	Fault history 3	Read	
40504	Fault history 4	Read	
40505	Fault history 5	Read	
40506	Fault history 6	Read	
40507	Fault history 7	Read	
40508	Fault history 8	Read	

## Fault code list

Data	Definition
H00	No fault present
H10	E.OC1
H11	E.OC2
H12	E.OC3
H20	E.OV1
H21	E.OV2
H22	E.OV3
H30	E.THT
H31	E.THM
H40	E.FIN
H52	E.ILF

Data	Definition
H60	E.OLT
H70	E.BE
H80	E.GF
H81	E.LF
H90	E.OHT
HA1	E.OP1
HB0	E.PE
HB1	E.PUE
HB2	E.RET
HB3	E.PE2
HC0	E.CPU
HC5	E.IOH

Data	Definition
HC7	E.AIE
HC8	E.USB
HD8	E.MB4
HD9	E.MB5
HDA	E.MB6
HDB	E.MB7
HF1	E.1
HF6	E.6
HF7	E.7
HFD	E.13

\* Refer to page 271 for details of fault definition.

### (7) Pr. 343 Communication error count

You can check the cumulative number of communication errors.

Parameter	Setting Range	Minimum Setting Range	Initial Value
343	(Reading only)	1	0



#### NOTE

The number of communication errors is temporarily stored into the RAM. As it is not stored into the EEPROM performing a power supply reset or inverter reset clears the value to 0.

### (8) Output terminal LF "alarm output (communication error warnings)"

During a communication error, the alarm signal (LF signal) is output by open collector output. Assign the used terminal using any of Pr. 190 to Pr. 192 (output terminal function selection).

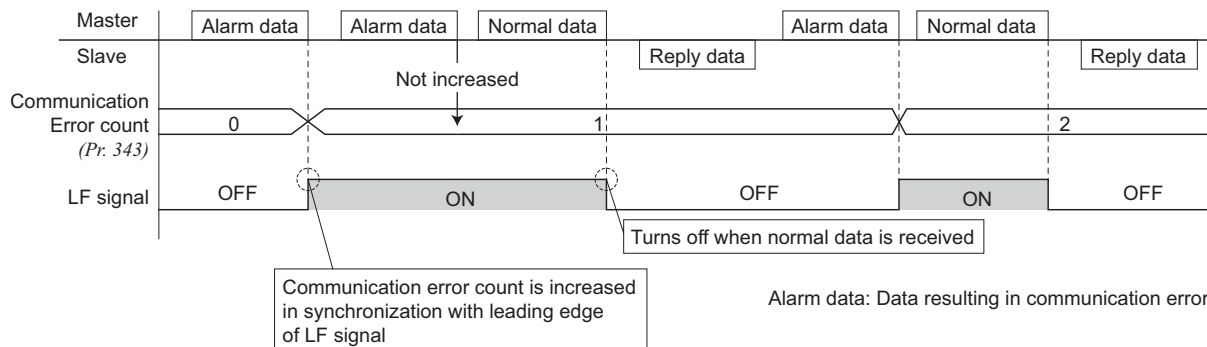

#### NOTE

The LF signal can be assigned to the output terminal using any of Pr.190 to Pr.192. Changing the terminal assignment may affect the other functions. Make setting after confirming the function of each terminal.

4.20.7 USB communication (Pr. 547, Pr. 548)

Inverter setup can be easily performed using the FR Configurator by connecting the inverter and personal computer with a USB cable.

- A personnel computer and inverter can be easily connected with one USB cable.

Parameter Number	Name	Initial Value	Setting Range	Description
547	USB communication station number	0	0 to 31	Inverter station number specification
548	USB communication check time interval	9999	0	USB communication is possible Trips in the PU operation mode (E.USB)
			0.1 to 999.8s	Sets the interval of communication check time. If a no-communication state persists for longer than the permissible time, the inverter will come to trip (E.USB).
			9999	No communication check

•USB communication specifications

Interface	Conforms to USB1.1
Transmission Speed:	12Mbps
Wiring Length	Maximum 5m (16.4 feet)
Connector	USB mini B connector (receptacle mini B type)
Power supply	Self-power supply

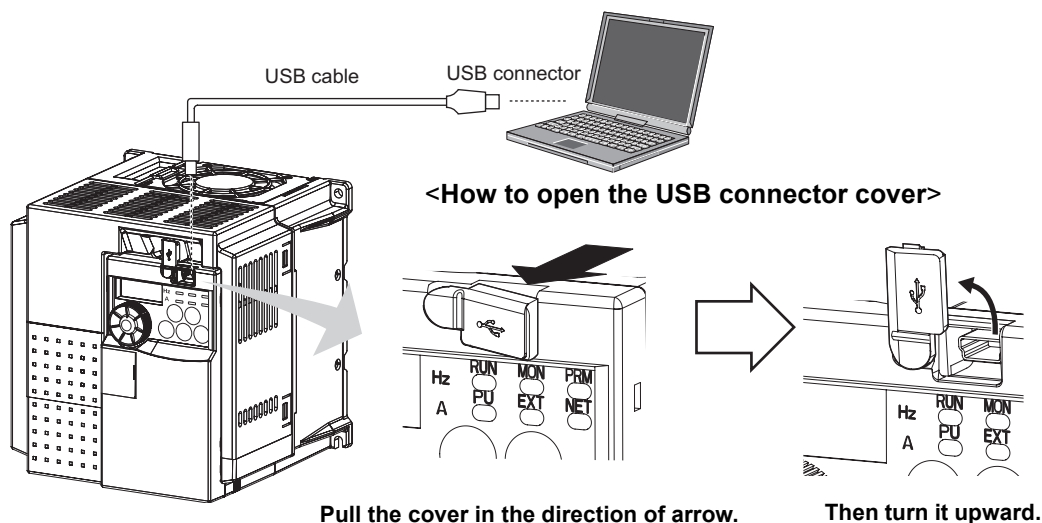

- You can perform parameter setting and monitoring with the FR Configurator. Refer to the instruction manual of the FR Configurator for details.

**REMARKS**

- Information on USB cable

Name	Inverter Type	Application/Specifications
USB cable	MR-J3USBCBL3M Cable length 3m (9.8 feet)	Connector for amplifier mini-B connector (5 pin)      Connector for personal computer A connector



**Parameters referred to**

Pr. 551 PU mode operation command source selection Refer to page 194

## 4.21 Special operation and frequency control

Purpose	Parameter that should be Set		Refer to Page
Perform process control such as pump and air volume.	PID control	Pr. 127 to Pr. 134	234
Dancer control	PID control (dancer control setting)	Pr. 44, Pr. 45, Pr. 128 to Pr. 134	241
Frequency control appropriate for load torque	Droop control	Pr. 286, Pr. 287	247
Avoid overvoltage alarm due to regeneration by automatic adjustment of output frequency	Regeneration avoidance function	Pr. 882, Pr. 883, Pr. 885, Pr. 886	248

### 4.21.1 PID control (Pr. 127 to Pr. 134)

The inverter can be used to exercise process control, e.g. flow rate, air volume or pressure.

The terminal 2 input signal or parameter setting is used as a set point and the terminal 4 input signal used as a feedback value to constitute a feedback system for PID control.

Parameter Number	Name	Initial Value	Setting Range	Description		
127	PID control automatic switchover frequency	9999	0 to 400Hz	Frequency at which the control is automatically changed to PID control.		
			9999	Without PID automatic switchover function		
128	PID action selection	0	0	PID action is not performed		
			20	PID reverse action	Measured value (terminal 4)	
			21	PID forward action		Set value (terminal 2 or Pr. 133)
			40	PID reverse action	Addition method: fixed	For dancer control set point (Pr. 133), measured value (terminal 4)
			41	PID forward action		
			42	PID reverse action	Addition method: ratio	main speed (frequency command of the operation mode)
			43	PID forward action		
			50	PID reverse action	Deviation value signal input (LONWORKS, CC-Link communication)	
			51	PID forward action		
			60	PID reverse action	Measured value, set point input (LONWORKS, CC-Link communication)	
61	PID forward action					
129 *1	PID proportional band	100%	0.1 to 1000%	If the proportional band is narrow (parameter setting is small), the manipulated variable varies greatly with a slight change of the measured value. Hence, as the proportional band narrows, the response sensitivity (gain) improves but the stability deteriorates, e.g. hunting occurs. Gain $K_p = 1/\text{proportional band}$		
			9999	No proportional control		
130 *1	PID integral time	1s	0.1 to 3600s	For deviation step input, time (Ti) required for only the integral (I) action to provide the same manipulated variable as that for the proportional (P) action. As the integral time decreases, the set point is reached earlier but hunting occurs more easily.		
			9999	No integral control.		
131	PID upper limit	9999	0 to 100%	Maximum value If the feedback value exceeds the setting, the FUP signal is output. The maximum input (20mA/5V/10V) of the measured value (terminal 4) is equivalent to 100%.		
			9999	No function		
132	PID lower limit	9999	0 to 100%	Minimum frequency If the process value falls below the setting range, the FDN signal is output. The maximum input (20mA/5V/10V) of the measured value (terminal 4) is equivalent to 100%.		
			9999	No function		
133 *1	PID action set point	9999	0 to 100%	Used to set the set point for PID control.		
			9999	Terminal 2 input is the set point.		
134 *1	PID differential time	9999	0.01 to 10.00s	For deviation ramp input, time (Td) required for providing only the manipulated variable for the proportional (P) action. As the differential time increases, greater response is made to a deviation change.		
			9999	No differential control.		

The above parameters can be set when Pr. 160 User group read selection = "0". (Refer to page 180)

\*1 Pr. 129, Pr. 130, Pr. 133 and Pr. 134 can be set during operation. They can also be set independently of the operation mode.

**(1) PID control basic configuration**

•Pr. 128 = "20, 21" (measured value input)

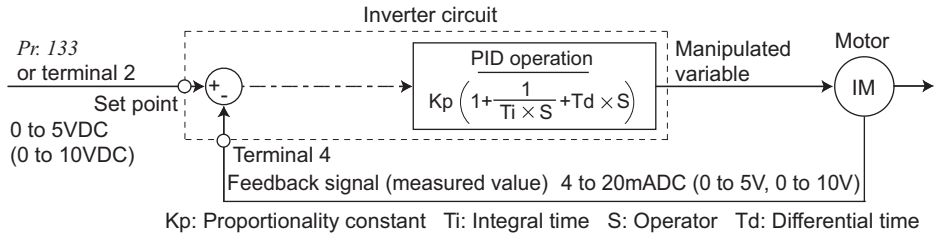

**(2) PID action overview**

1)PI action

A combination of proportional control action (P) and integral control action (I) for providing a manipulated variable in response to deviation and changes with time.

[Operation example for stepped changes of process value]

(Note) PI action is the sum of P and I actions.

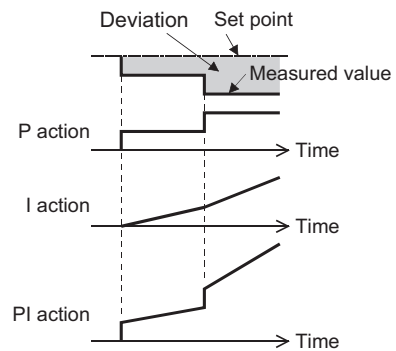

2)PD action

A combination of proportional control action (P) and differential control action (D) for providing a manipulated variable in response to deviation speed to improve the transient characteristic.

[Operation example for proportional changes of process value]

(Note) PD action is the sum of P and D actions.

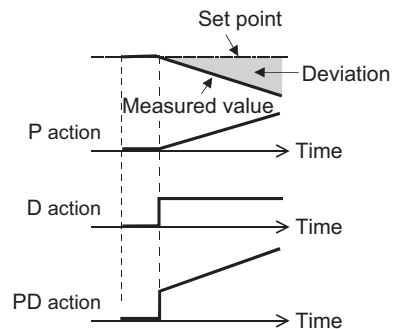

3)PID action

The PI action and PD action are combined to utilize the advantages of both actions for control.

(Note) PID action is the sum of P, I and D actions.

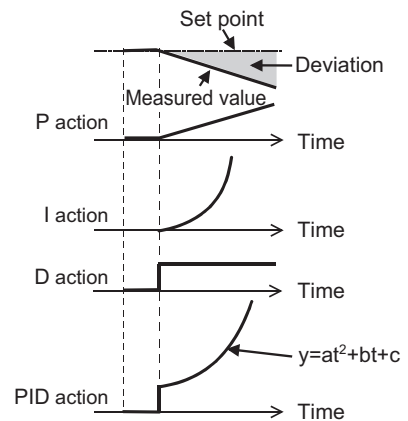

## 4) Reverse operation

Increases the manipulated variable (output frequency) if deviation  $X = (\text{set point} - \text{measured value})$  is positive, and decreases the manipulated variable if deviation is negative.

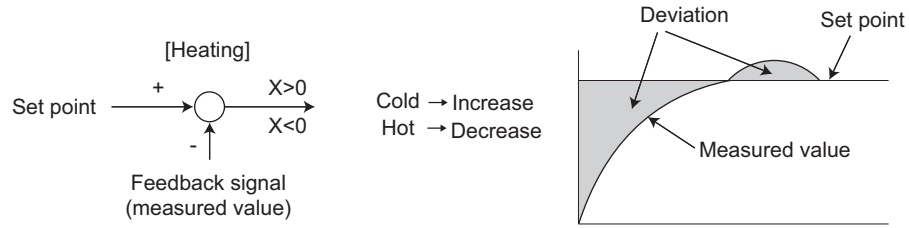

## 5) Forward action

Increases the manipulated variable (output frequency) if deviation  $X = (\text{set point} - \text{measured value})$  is negative, and decreases the manipulated variable if deviation is positive.

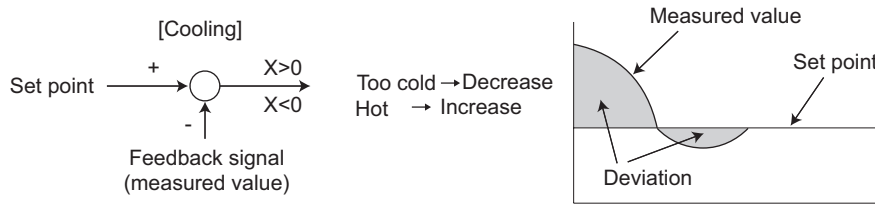

Relationships between deviation and manipulated variable (output frequency)

	Deviation	
	Positive	Negative
Reverse action	↗	↘
Forward action	↘	↗

## (3) Connection diagram

- Sink logic
- Pr. 128 = 20
- Pr. 183 = 14
- Pr. 190 = 15
- Pr. 191 = 14
- Pr. 192 = 16

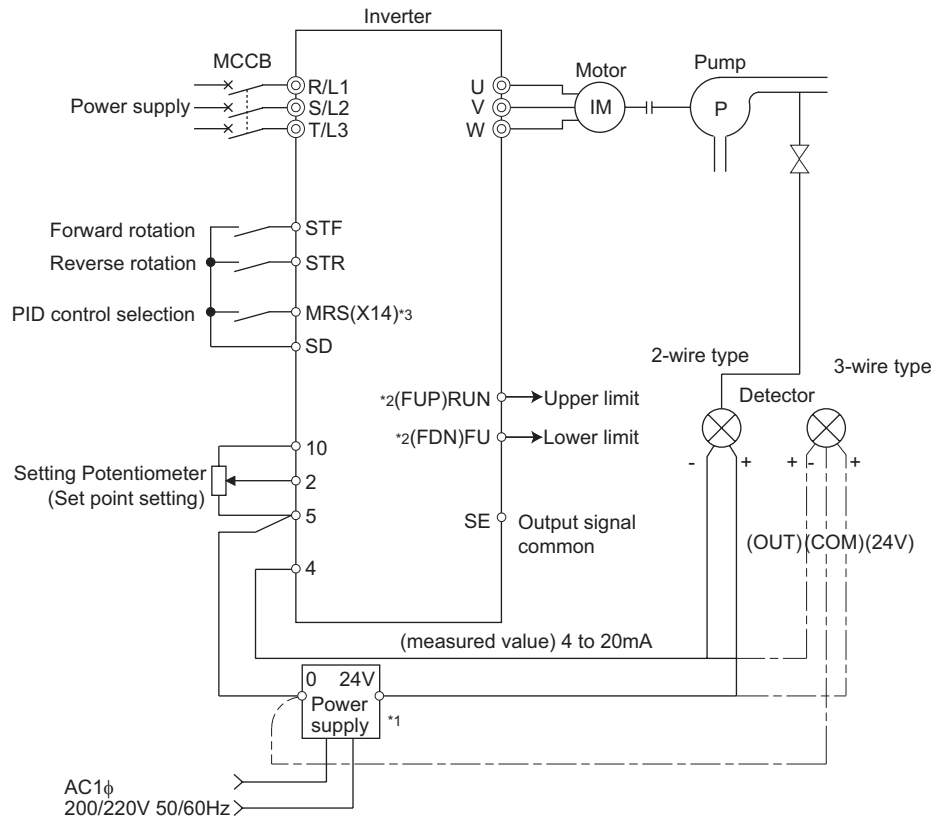

- \*1 The power supply must be selected in accordance with the power specifications of the detector used.
- \*2 The used output signal terminal changes depending on the Pr. 190 to Pr. 192 (output terminal selection) setting.
- \*3 The used input signal terminal changes depending on the Pr. 178 to Pr. 184 (input terminal selection) setting.

**(4) I/O signals and parameter setting**

- Set "20, 21, 50, 51, 60 or 61" in Pr. 128 to perform PID operation.
  - Set "14" in any of Pr. 178 to Pr. 184 (input terminal function selection) to assign PID control selection signal (X14) to turn the X14 signal on.
- When the X14 signal is not assigned, only the Pr. 128 setting makes PID control valid.
- Enter the set point using the inverter terminal 2 or Pr. 133 and enter the measured value to terminal 4.

 **REMARKS**

- When Pr. 128 = "0" or X14 signal is off, normal inverter operation is performed without PID action.
- Turning ON/OFF of bit of the terminal, to which X14 signal is assigned through network as RS-485 communication, enables PID control.

	Signal	Terminal Used	Function	Description	Parameter Setting
Input	X14	Depending on Pr. 178 to Pr. 184	PID control selection	Turn on X14 signal to perform PID control. *1	Set 14 in any of Pr. 178 to Pr. 184.
	2	2	Set point input	You can input the set point for PID control.	Pr. 128 = 20, 21, Pr. 133 = 9999
				0 to 5V ..... 0 to 100%	Pr. 73 = 1 *2, 11
				0 to 10V .... 0 to 100%	Pr. 73 = 0, 10
	PU	—	Set point input	Set the set point (Pr. 133) from the operation panel.	Pr. 128 = 20, 21 Pr. 133 = 0 to 100%
	4	4	Measured value input	Input the signal from the detector (measured value signal).	Pr. 128 = 20, 21
4 to 20mA . 0 to 100%				Pr. 267 = 0 *2	
0 to 5V ..... 0 to 100%				Pr. 267 = 1	
0 to 10V .... 0 to 100%				Pr. 267 = 2	
Communication *3	—	Deviation value input	Inputs the deviation value from LONWORKS, CC-Link communication.	Pr. 128 = 50, 51	
		Set point, measured value input	Inputs the set point and deviation value from LONWORKS, CC-Link communication.	Pr. 128 = 60, 61	
Output	FUP	Depending on Pr. 190 to Pr. 192	Upper limit output	Output to indicate that the process value signal exceeded the maximum value (Pr. 131).	Pr. 128 = 20, 21, 60, 61 Pr. 131 ≠ 9999 Set 15 or 115 in any of Pr. 190 to Pr. 192. *4
	FDN		Lower limit output	Output when the process value signal falls below the minimum value (Pr. 132).	Pr. 128 = 20, 21, 60, 61 Pr. 132 ≠ 9999 Set 14 or 114 in any of Pr. 190 to Pr. 192. *4
	RL		Forward (reverse) rotation direction output	"Hi" is output to indicate that the output indication of the parameter unit is forward rotation (FWD) or "Low" to indicate that it is reverse rotation (REV) or stop (STOP).	Set 16 or 116 in any of Pr. 190 to Pr. 192. *4
	PID		During PID control activated	Turns on during PID control.	Set 47 or 147 in any of Pr. 190 to Pr. 192. *4
	SE		SE	Output terminal common	Common terminal for terminals FUP, FDN, RL, and PID

\*1 When the X14 signal is not assigned, only the Pr. 128 setting makes PID control valid.  
 \*2 The shaded area indicates the parameter initial value.  
 \*3 Refer to the CC-Link communication option (FR-A7NC E kit) instruction manual for the setting method from CC-Link communication. Refer to the LONWORKS communication option (FR-A7NL E kit) instruction manual for the setting method from LONWORKS communication.  
 \*4 When 100 or larger value is set in any of Pr.190 to Pr.192 (output terminal function selection), the terminal output has negative logic. (For details, Refer to page 137)

 **NOTE**

- Changing the terminal function using any of Pr. 178 to Pr. 184 and Pr. 190 to Pr. 192 may affect the other functions. Make setting after confirming the function of each terminal.
- When the Pr. 267 setting was changed, check the voltage/current input switch setting. Different setting may cause a fault, failure or malfunction. (Refer to page 168 for setting)

### (5) PID automatic switchover control (Pr. 127)

- The system can be started up without PID control only at a start.
- When the frequency is set to *Pr. 127 PID control automatic switchover frequency* within the range 0 to 400Hz, the inverter starts up without PID control from a start until output frequency is reached to the set frequency of *Pr. 127*, and then it shifts to PID control. Once the system has entered PID control operation, it continues PID control if the output frequency falls to or below *Pr.127*.

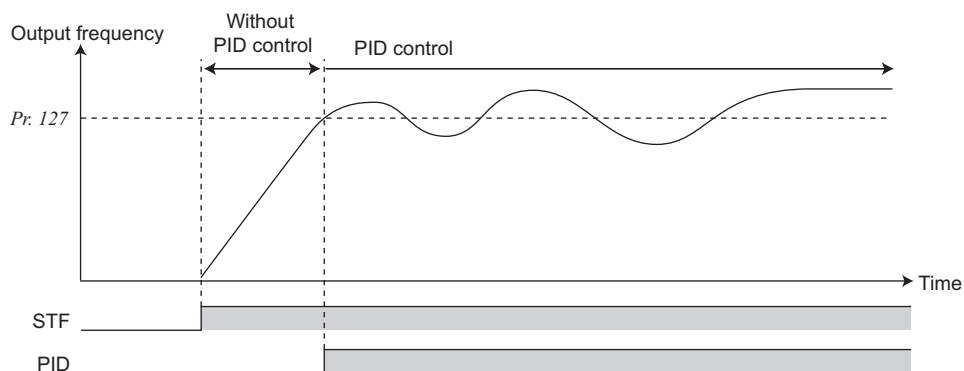

### (6) PID monitor function

- The PID control set point and measured value can be displayed on the operation panel and output from terminal AM.
- The deviation monitor displays a negative value on the assumption that 1000 is 0%. (The deviation monitor cannot be output from the terminal AM.)
- For each monitor, set the following value in *Pr. 52 DU/PU main display data selection* and *Pr. 158 AM terminal function selection*.

Setting	Monitor Description	Minimum Increments	Terminal AM Full Scale	Remarks
52	PID set point	0.1%	100%	—
53	PID measured value	0.1%	100%	
54	PID deviation value	0.1%	—	Value cannot be set to <i>Pr. 158</i> . Displays 1000 when the PID deviation is 0%.



(7) Adjustment procedure

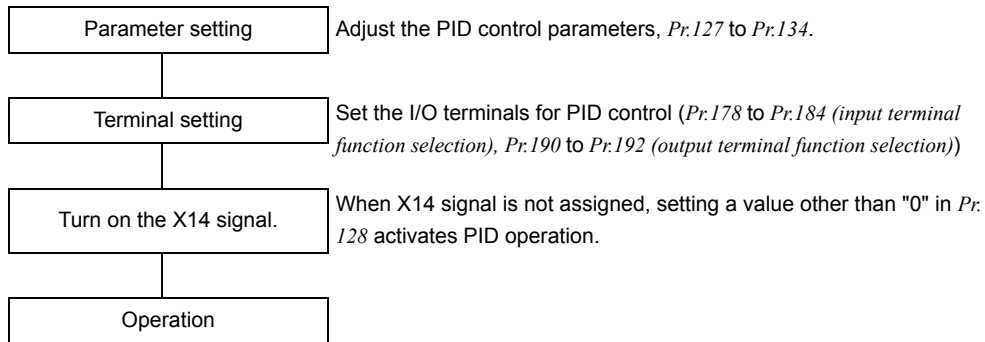

(8) Calibration example

(A detector of 4mA at 0°C (32°F) and 20mA at 50°C (122°F) is used to adjust the room temperature to 25°C (77°F) under PID control.

The set point is given to across inverter terminals 2-5 (0 to 5V).)

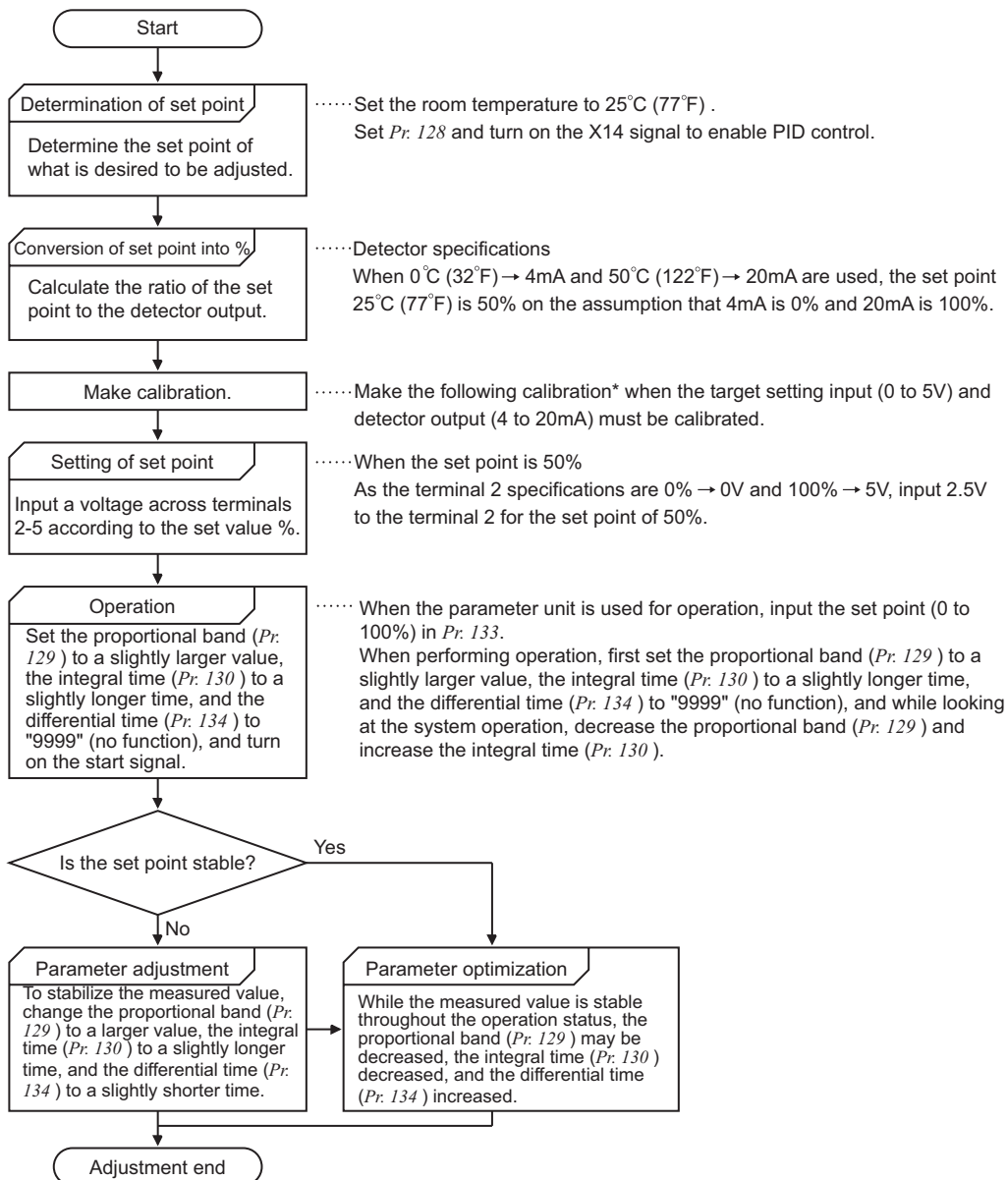

\*When calibration is required → Using calibration Pr. 902 and Pr. 903 (terminal 2) or Pr. 904 and Pr. 905 (terminal 4), calibrate the detector output and target setting input. Make calibration in the PU mode during an inverter stop.

### <Set point input calibration>

1. Apply the input voltage of 0% set point setting (e.g. 0V) across terminals 2-5.
2. Enter in C2 (Pr. 902) the frequency which should be output by the inverter at the deviation of 0% (e.g. 0Hz).
3. In C3 (Pr.902), set the voltage value at 0%.
4. Apply the voltage of 100% set point (e.g. 5V) to across terminals 2-5.
5. Enter in Pr.125 the frequency which should be output by the inverter at the deviation of 100% (e.g. 60Hz).
6. In C4 (Pr.903), set the voltage value at 100%.

### <Measured value calibration>

1. Apply the input current of 0% measured value (e.g. 4mA) across terminals 4-5.
2. Make calibration using C6 (Pr. 904).
3. Apply the input current of 100% measured value (e.g. 20mA) across terminals 4-5.
4. Make calibration using C7 (Pr. 905).



### REMARKS

- The frequency set in C5 (Pr. 904) and Pr. 126 should be the same as set in C2 (Pr. 902) and Pr. 125.

The results of the above calibration are as shown below:

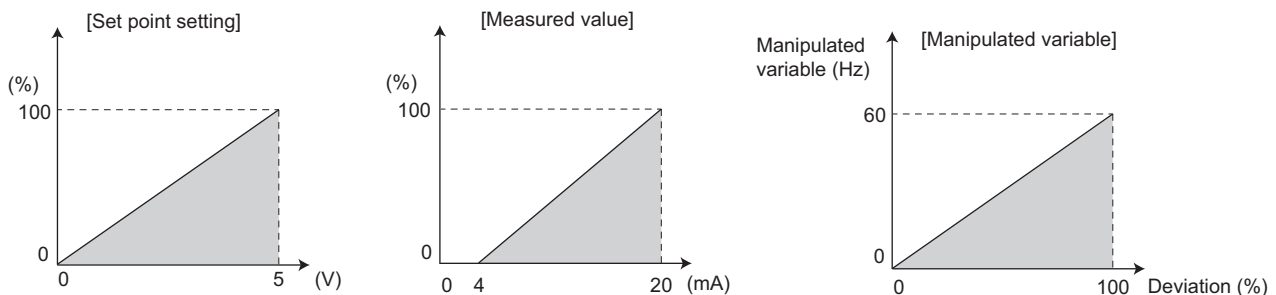

### NOTE

- If the multi-speed (RH, RM, RL signal) or jog operation (jog signal) is entered with the X14 signal on, PID control is stopped and multi-speed or jog operation started.
- If the setting is as follows, PID control becomes invalid.  
Pr. 79 Operation mode selection = "6" (switchover mode)  
When the inverter is at a stop with Pr. 261 Power failure stop selection selected.
- Changing the terminal function using any of Pr. 178 to Pr. 184, Pr. 190 to Pr. 192 may affect the other functions. Make setting after confirming the function of each terminal.
- When PID control is selected, the minimum frequency is the frequency set in Pr. 902 and the maximum frequency is the frequency set in Pr. 903.  
Pr. 1 Maximum frequency and Pr. 2 Minimum frequency settings are also valid.
- The remote operation function is invalid during PID operation.
- When the control is switched to PID control during normal operation, the frequency command value calculated by PID operation using 0Hz as standard is used without the frequency during the operation.

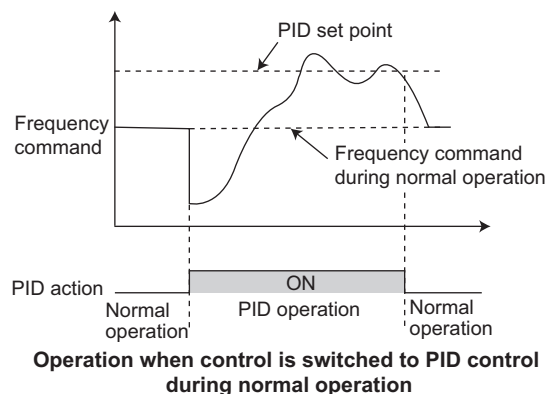

### Parameters referred to

- Pr. 59 Remote function selection Refer to page 99
- Pr. 73 Analog input selection Refer to page 168
- Pr. 79 Operation mode selection Refer to page 183
- Pr. 178 to Pr. 184 (input terminal function selection) Refer to page 131
- Pr. 190 to Pr. 192 (output terminal function selection) Refer to page 137
- Pr. 261 Power failure stop selection Refer to page 160
- C2 (Pr. 902) to C7 (Pr. 905) Frequency setting voltage (current) bias/gain Refer to page 171

**4.21.2 Dancer control (Pr. 44, Pr. 45, Pr. 128 to Pr. 134)**

Performs PID control by feedbacking the position detection of the dancer roller, controlling the dancer roller is in the specified position.

Parameter Number	Name	Initial Value		Setting Range	Description		
44	Second acceleration/ deceleration time	FR-E720-175 or less	5s	0 to 3600/360s	This parameter is the acceleration time of the main speed during dancer control. It will not function as second acceleration/deceleration time.		
		FR-E740-095 or less					
		FR-E720-240 and 330 FR-E740-120 and 170 FR-E720-470 and 600	10s 15s				
45	Second deceleration time	9999		0 to 3600/360s	This parameter is the deceleration time of the main speed during dancer control. It will not function as second deceleration time.		
				9999			
128	PID action selection	0		0	PID action is not performed		
				20	PID reverse action	Measured value (terminal 4) Set value (terminal 2 or Pr. 133)	
				21	PID forward action		
				40	PID reverse action	Addition method: fixed	For dancer control set point (Pr. 133), measured value (terminal 4) main speed (speed command of the operation mode)
				41	PID forward action	Addition method: fixed	
				42	PID reverse action	Addition method: ratio	
				43	PID forward action	Addition method: ratio	
				50	PID reverse action	Deviation value signal input (LONWORKS, CC-Link communication)	
				51	PID forward action		
				60	PID reverse action	Set point and measured value input (LONWORKS, CC-Link communication)	
				61	PID forward action		
129 *1	PID proportional band	100%		0.1 to 1000%	If the proportional band is narrow (parameter setting is small), the manipulated variable varies greatly with a slight change of the measured value. Hence, as the proportional band narrows, the response sensitivity (gain) improves but the stability deteriorates, e.g. hunting occurs. Gain $K_p = 1/\text{proportional band}$		
				9999	No proportional control		
130 *1	PID integral time	1s		0.1 to 3600s	For deviation step input, time (Ti) required for only the integral (I) action to provide the same manipulated variable as that for the proportional (P) action. As the integral time decreases, the set point is reached earlier but hunting occurs more easily.		
				9999	No integral control.		
131	PID upper limit	9999		0 to 100%	Maximum value If the feedback value exceeds the setting, the FUP signal is output. The maximum input (20mA/5V/10V) of the measured value (terminal 4) is equivalent to 100%.		
				9999	No function		

Parameter Number	Name	Initial Value	Setting Range	Description
132	PID lower limit	9999	0 to 100%	Minimum value If the process value falls below the setting range, the FDN signal is output. The maximum input (20mA/5V/10V) of the measured value (terminal 4) is equivalent to 100%.
			9999	No function
133 *1	PID action set point	9999	0 to 100%	Used to set the set point for PID control.
			9999	Always 50%
134 *1	PID differential time	9999	0.01 to 10.00s	For deviation ramp input, time (Td) required for providing only the manipulated variable for the proportional (P) action. As the differential time increases, greater response is made to a deviation change.
			9999	No differential control.

The above parameters can be set when Pr.160 User group read selection = "0". (Refer to page 180)

\*1 Pr.129, Pr.130, Pr.133 and Pr.134 can be set during operation. They can also be set independently of the operation mode.

## (1) Dancer control block diagram

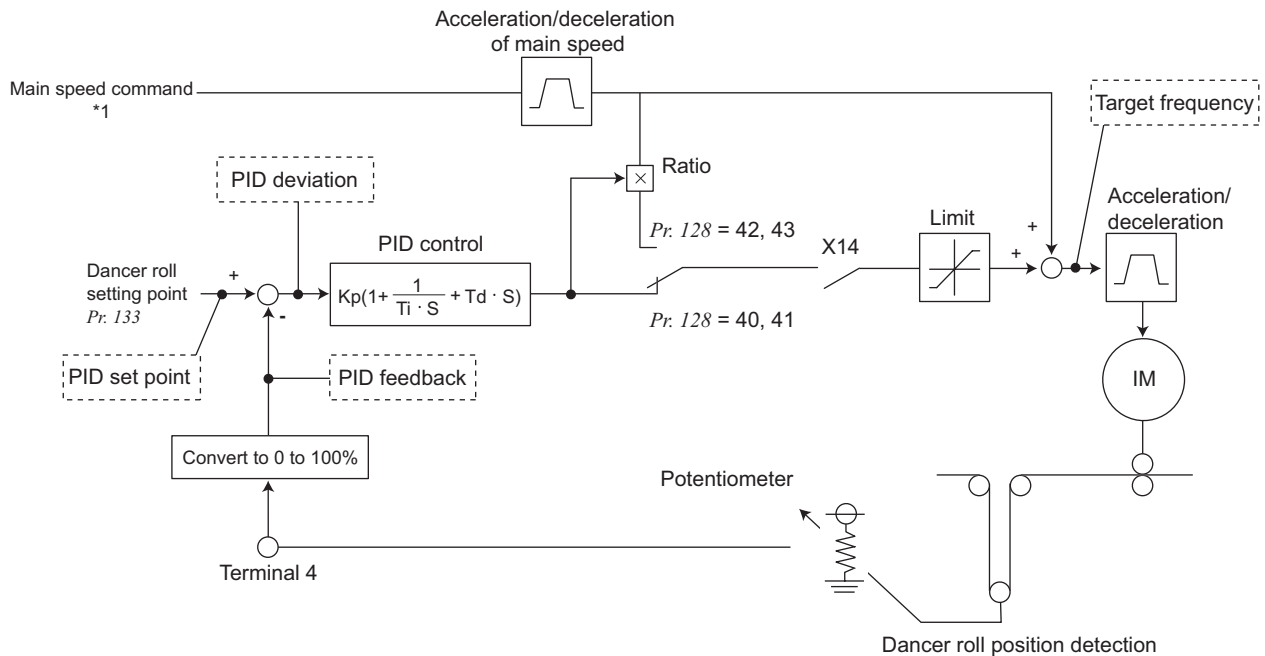

\*1 The main speed can be selected from all operation mode such as external (analog voltage input, multi-speed), PU (digital frequency setting), communication (RS-485, CC-Link).

## Set point and measured value of PID control

	Input	Input Signal	Pr.267 Setting	Current/Voltage Input Switch
Set point	Pr. 133	0 to 100%	—	—
Measured value	When measured value is input as current (4 to 20mA)	4mA ..... 0%, 20mA... 100%	0	
	When measured value is input as voltage (0 to ±5V or 0 to ±10V)	0V ..... 0%, 5V ..... 100%	1	
		0V ..... 0%, 10V ..... 100%	2	



### NOTE

- Changing the terminal function using any of Pr.178 to Pr.184 may affect the other functions. Make setting after confirming the function of each terminal.
- When the Pr. 267 setting was changed, check the voltage/current input switch setting. Different setting may cause a fault, failure or malfunction. (Refer to page 168 for setting)

**(2) Dancer control overview**

Performs dancer control by setting 40 to 43 in *Pr. 128 PID operation selection*. The main speed command is the speed command of each operation mode (external, PU, communication). Performs PID control by the position detection signal of the dancer roller, then the result is added to the main speed command. For acceleration/deceleration of the main speed, set the acceleration time in *Pr. 44 Second acceleration/deceleration time* in *Pr. 45 Second deceleration time*.

\* Set 0s normally to *Pr.7 Acceleration time* and *Pr.8 Deceleration time*. When the *Pr. 7 and Pr. 8* setting is large, response of dancer control during acceleration/ deceleration is slow.

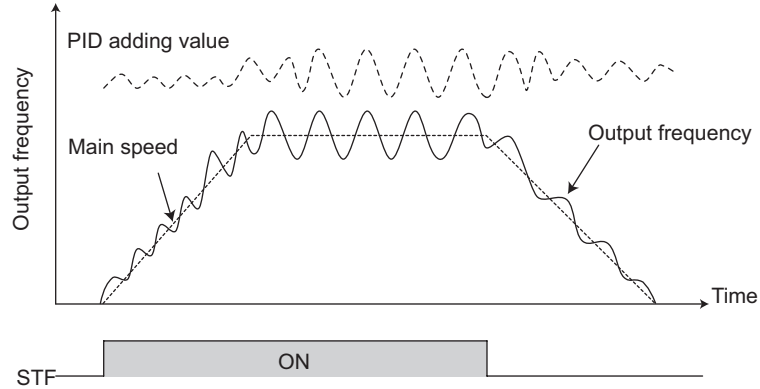

**(3) Connection diagram**

- Sink logic
- *Pr. 128* = 41
- *Pr. 183* = 14
- *Pr. 190* = 15
- *Pr. 191* = 14
- *Pr. 192* = 16

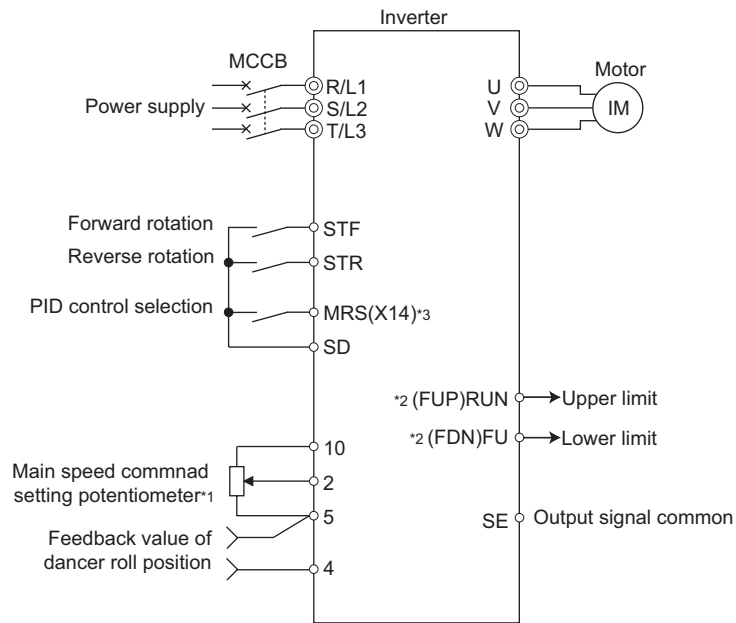

\*1 The main speed command differs according to each operation mode (external, PU, communication)  
 \*2 The used output signal terminal changes depending on the *Pr. 190 to Pr. 192 (output terminal selection)* setting.  
 \*3 The used input signal terminal changes depending on the *Pr. 178 to Pr. 184(input terminal selection)* setting.

### (4) I/O signals and parameter setting

- Set "40 to 43" in *Pr. 128* to perform dancer control.
- Set "14" in any of *Pr. 178 to Pr. 184* (input terminal function selection) to assign PID control selection signal (X14) to turn the X14 signal on.

When the X14 signal is not assigned, only the *Pr. 128* setting makes dancer control valid.

- Input the main speed command (external, PU, communication). The main speed command in any operation mode can be input. (Note that terminal 4 can not be used as the main speed command.)
- Input the set point using *Pr. 133*, then input the measured value signal (dancer roller position detection signal) across terminal 4 and 5 of the inverter.



#### REMARKS

- When *Pr. 128* = "0" or X14 signal is off, normal inverter operation is performed without dancer control.
- Turning ON/OFF of bit of the terminal, to which X14 signal is assigned through network as RS-485 communication, enables dancer control.

Signal	Terminal Used	Function	Description	Parameter Setting	
Input	X14	Depending on <i>Pr. 178 to Pr. 184</i>	PID control selection	Turn on X14 signal to perform dancer control. *1	Set 14 in any of <i>Pr. 178 to Pr. 184</i> .
	4	4	Measured value input	Input the signal from the dancer roller detector (measured value signal).	<i>Pr.128</i> = 40, 41, 42, 43
				4 to 20mA...0 to 100%	<i>Pr.267</i> = 0 *2
				0 to 5V.....0 to 100%	<i>Pr.267</i> = 1
			0 to 10V.....0 to 100%	<i>Pr.267</i> = 2	
Output	FUP	Depending on <i>Pr. 190 to Pr. 192</i>	Upper limit output	Output to indicate that the measured value signal exceeded the maximum value ( <i>Pr. 131</i> ).	<i>Pr.128</i> = 40, 41, 42, 43 <i>Pr.131</i> ≠ 9999 Set 15 or 115 in any of <i>Pr.190 to Pr.192</i> . *3
	FDN		Lower limit output	Output when the measured value signal falls below the minimum value ( <i>Pr. 132</i> ).	<i>Pr.128</i> = 40, 41, 42, 43 <i>Pr.132</i> ≠ 9999 Set 14 or 114 in any of <i>Pr.190 to Pr.192</i> . *3
	RL		Forward (reverse) rotation direction output	Output is "ON" when the output indication of the parameter unit is forward rotation (FWD) and "OFF" when reverse rotation (REV) or stop (STOP).	Set 16 or 116 in any of <i>Pr. 190 to Pr. 192</i> . *3
	PID		During PID control activated	Turns on during PID control.	Set 47 or 147 in any of <i>Pr. 190 to Pr. 192</i> . *3
	SE		SE	Output terminal common	Common terminal for terminals FUP, FDN, RL, and PID

\*1 When the X14 signal is not assigned, only the *Pr. 128* setting makes dancer control valid.

\*2 The shaded area indicates the parameter initial value.

\*3 When 100 or larger value is set in any of *Pr. 190 to Pr. 192* (output terminal function selection), the terminal output has negative logic. (For details, Refer to page 137)



#### NOTE

- Changing the terminal function using any of *Pr. 178 to Pr. 184* and *Pr.190 to Pr.192* may affect the other functions. Make setting after confirming the function of each terminal.
- When the *Pr. 267* setting was changed, check the voltage/current input switch setting. Different setting may cause a fault, failure or malfunction. (Refer to page 168 for setting)

(5) Parameter details

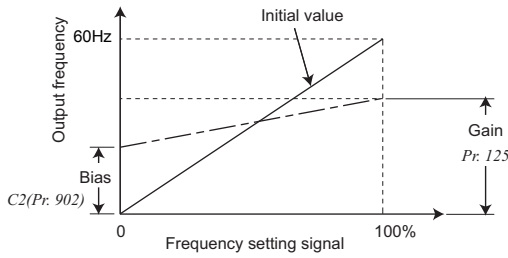

•When ratio (*Pr. 128* = "42, 43") is selected for addition method, PID control × (ratio of main speed) is added to the main speed. The ratio is determined by the *Pr. 125 Terminal 2 frequency setting gain frequency* and *C2 (Pr. 902) Terminal 2 frequency setting bias frequency*. The frequency setting signal is set to 0 to 60Hz in the range between 0 to 100% in the initial setting. The ratio is (×100%) when the main speed is 60Hz and (×50%) when 30Hz.



**NOTE**

- Even when *C4 (Pr. 903)* is set to other than 100%, the frequency setting signal is considered as 100%.
- Even when *C3 (Pr. 903)* is set to other than 0%, the frequency setting signal is considered as 0%.
- When *C2 (Pr. 902)* is set to other than 0Hz, the frequency setting signal is 0% when *C2 (Pr. 902)* is less than the set frequency.

- Turning X14 signal on/off during operation by assigning X14 signal results in the following operation.  
When X14 signal is on: Uses output frequency unchanged as the main speed command and continues operation by dancer control.  
When X14 signal is off: Ends dancer control and continues operation at the set frequency made valid.

<i>Pr. 128</i> Setting	PID Action	Addition Method	Set Point	Measured Value	Main Speed Command
40	Reverse action	Fixed	<i>Pr. 133</i>	Terminal 4	Speed command for each operation mode
41	Forward action				
42	Reverse action	Ratio			
43	Forward action				

- Action of *Pr. 129 PID proportional band*, *Pr. 130 PID integral time*, *Pr. 131 PID upper limit*, *Pr. 132 PID lower limit*, *Pr. 134 PID differential time* is the same as PID control. For the relationship of controlled variable (%) of PID control and frequency, 0% is equivalent to the set frequency of *Pr. 902* and 100% to *Pr. 903*.
- For the *Pr. 133 PID action set point* setting, set frequency of *Pr. 902* is equivalent to 0% and *Pr. 903* to 100%. When 9999 is set in *Pr. 133*, 50% is the set point.



**REMARKS**

*Pr. 127 PID control automatic switchover frequency* is invalid.

(6) Output signal

- Output terminal assignment during dancer control (PID control) operation  
PID signal turns on during dancer control (PID control) or at a stop by PID control (in the status PID operation being performed inside) (The signal is off during normal operation.)  
For the terminal used for PID signal output, assign the function by setting "47 (positive logic) or 147 (negative logic)" in any of *Pr. 190* to *Pr. 192 (output terminal function selection)*.



**NOTE**

- Changing the terminal function using any of *Pr. 178* to *Pr. 184*, *Pr. 190* to *Pr. 192* may affect the other functions. Make setting after confirming the function of each terminal.

(7) PID monitor function

- The PID control set point and measured value can be output to the operation panel monitor display and terminal AM.
- For each monitor, set the following value in *Pr. 52 DU/PU main display data selection* and *Pr. 158 AM terminal function selection*.

Setting	Monitor Description	Minimum Increments	Terminal AM Full Scale	Remarks
52	PID set point	0.1%	100%	—
53	PID measured value	0.1%	100%	
54	PID deviation value	0.1%	—	Value cannot be set in <i>Pr. 158</i> . Displays 1000 when the PID deviation is 0%.

(8) Priorities of main speed command

- The priorities of the main speed speed command source when the speed command source is external are as follows.  
JOG signal > multi-speed setting signal (RL/RM/RH/REX) > 16 bit digital input (option) > terminal 2
- The priorities of the main speed speed command source when "3" is set in *Pr. 79*.  
Multi-speed setting signal (RL/RM/RH/REX) > set frequency (digital setting by PU, operation panel)
- Terminal 4 can not be selected as the main speed speed command even when AU terminal is turned on.
- Even when a remote operation function is selected by setting a value other than "0" in *Pr. 59*, compensation of the remote setting frequency to the main speed is ignored (changes to 0).

### (9) Adjustment procedure

#### ●Dancer roller position detection signal adjustment

When terminal 4 input is voltage input, 0V is minimum position and 5V(10V) is maximum position. When current is input, 4mA is minimum position and 20mA is maximum position. (initial value) When 0 to 7V is output from the potentiometer, it is necessary to calibrate C7 (Pr.905) at 7V.

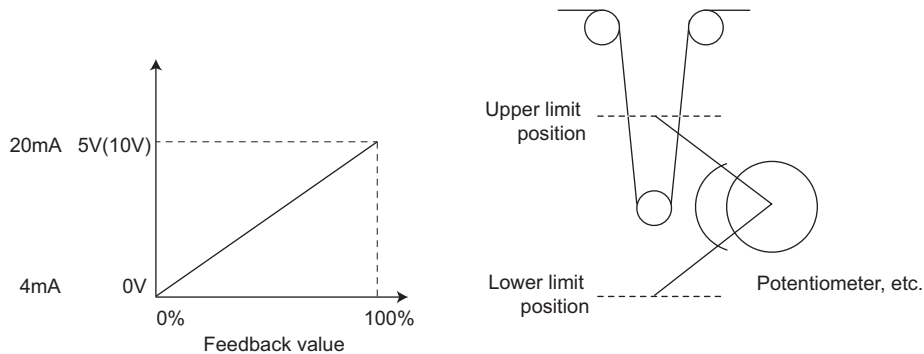

(Example) Control at a dancer center position using a 0 to 7V potentiometer

- 1) After changing the current/voltage input switch to "V", set "2" in Pr. 267 to change terminal 4 input to voltage input.
- 2) Input 0V to across terminal 4 and 5 to calibrate C6 (Pr. 904). (% display displayed at analog calibration is irrelevant to % of the feed back value.)
- 3) By inputting 7V to across terminal 4 to 5, calibrate C7(Pr. 905) (% display displayed at analog calibration is irrelevant to % of the feed back value.)
- 4) Set 50% in Pr.133.



#### NOTE

When the Pr. 267 setting was changed, check the voltage/current input switch setting. Different setting may cause a fault, failure or malfunction. (Refer to page 168 for setting)



#### REMARKS

- In normal PID control, PID control is stopped when multi-speed operation signal (RH, RM, RL, REX signal) or JOG signal is input. In dancer control, however, PID control continues handling the signals as the main speed.
- During dancer control, *Second acceleration/deceleration time* of Pr.44 and Pr.45 are the parameters for acceleration/deceleration time setting to the main speed command source. They do not function as the second function.
- When switchover mode is set with "6" in Pr. 79 , dancer control (PID control) is invalid.
- Speed command of terminal 4 input from terminal AU is invalid when dancer control is selected.
- Acceleration/deceleration of the main speed command is the same operation as when frequency command is increased/decreased by analog input.
  - Therefore, SU signal remains on even if the starting signal is turned on/off.(always in the constant speed state)
  - The DC brake operation starting frequency when turning off the starting signal is not Pr. 10 but a smaller value of either Pr. 13 or 0.5Hz.
  - The set frequency monitor is always variable as "main speed command+PID control".
- The main speed setting frequency accelerates for the acceleration/deceleration time set in Pr. 44 and Pr. 45 and the output frequency accelerates/decelerates for the acceleration/deceleration time set in Pr. 7 and Pr. 8. Therefore, when the set time of Pr. 7 and Pr. 8 is longer than Pr. 44 and Pr. 45, the output frequency accelerates/decelerates for the acceleration/deceleration time set in Pr. 7 and Pr. 8.
- For the integral term limit, a smaller value of either the PID manipulated variable (%) value converted from the linear, interpolated Pr. 1 Maximum frequency with Pr. 902 and Pr. 903 , or 100% is used for limit. Although the output frequency is limited by the minimum frequency, operation limit of the integral term is not performed.



#### Parameters referred to

- Pr. 59 Remote function selection Refer to page 99
- Pr. 73 Analog input selection Refer to page 168
- Pr. 79 Operation mode selection Refer to page 183
- Pr. 178 to Pr. 184 (input terminal function selection) Refer to page 131
- Pr. 190 to Pr. 192 (output terminal function selection) Refer to page 137
- C2 (Pr. 902) to C7 (Pr. 905) Frequency setting voltage (current) bias/gain Refer to page 171



4.21.3 Droop control (Pr. 286 to Pr. 287) 

This function is designed to balance the load in proportion to the load torque to provide the speed drooping characteristic under advanced magnetic flux vector control.  
 This function is effective for balancing the load when using multiple inverters

Parameter Number	Name	Initial Value	Setting Range	Description
286	Droop gain	0%	0	Droop control is invalid (Normal operation)
			0.1% to 100%	Droop control is valid Drooping amount at the rated torque as a percentage with respect to the rated motor frequency.
287	Droop filter time constant	0.3s	0 to 1s	Time constant of the filter applied on the torque current.

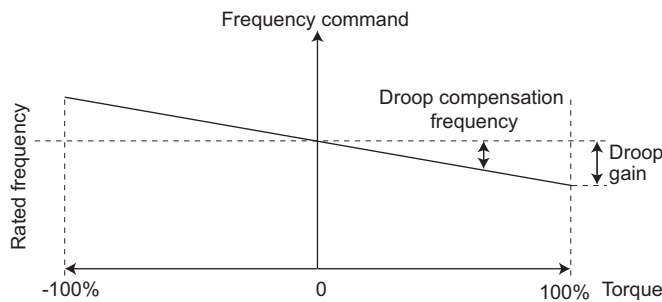

(1) Droop control



- The output frequency is changed according to the magnitude of torque current under advanced magnetic flux vector control. The drooping amount at the rated torque is set by the droop gain as a percentage using the rated frequency as a reference.
- The maximum droop compensation frequency is 120Hz.

$$\text{Droop compensation frequency} = \frac{\text{Torque current after filtering}}{\text{Rated value of torque current}} \times \frac{\text{Pr. 84 Rated motor frequency} \times \text{Pr. 286 Droop gain}}{100}$$

 **REMARKS**

- Set the droop gain to about the rated slip of the motor.
- $$\text{Rated slip} = \frac{\text{Synchronous speed at base frequency} - \text{rated speed}}{\text{Synchronous speed at base frequency}} \times 100[\%]$$
- Droop control is invalid during PID control operation.
  - The maximum value of frequency after droop compensation is either 120Hz or Pr. 1 Maximum frequency, whichever is smaller.

 **Parameters referred to**

Pr. 1 Maximum frequency  Refer to page 89  
 PID control  Refer to page 234

## 4.21.4 Regeneration avoidance function (Pr. 665, Pr. 882, Pr. 883, Pr. 885, Pr. 886)

This function detects a regeneration status and increases the frequency to avoid the regenerative status.

- Possible to avoid regeneration by automatically increasing the frequency and continue operation if the fan happens to rotate faster than the set speed due to the effect of another fan in the same duct.

Parameter Number	Name	Initial Value	Setting Range	Description	
882	Regeneration avoidance operation selection	0	0	Regeneration avoidance function invalid	
			1	Regeneration avoidance function is always valid	
			2	Regeneration avoidance function is valid only during a constant speed operation	
883	Regeneration avoidance operation level	200V class	400 VDC	300 to 800V	Bus voltage level at which regeneration avoidance operates. When the bus voltage level is set to low, overvoltage error will be less apt to occur. However, the actual deceleration time increases. The set value must be higher than the "power supply voltage $\times \sqrt{2}$ ".
		400V class	780 VDC		
885	Regeneration avoidance compensation frequency limit value	6Hz	0 to 10Hz	Limit value of frequency which rises at activation of regeneration avoidance function.	
			9999	Frequency limit invalid	
886	Regeneration avoidance voltage gain	100%	0 to 200%	Responsiveness at activation of regeneration avoidance. A larger setting will improve responsiveness to the bus voltage change. However, the output frequency could become unstable.	
665	Regeneration avoidance frequency gain	100%	0 to 200%	When vibration is not suppressed by decreasing the Pr. 886 setting, set a smaller value in Pr. 665.	

The above parameters can be set when Pr. 160 User group read selection = "0". (Refer to page 180)

### (1) What is regeneration avoidance function? (Pr. 882, Pr. 883)

- When the regeneration load is large, the DC bus voltage rises and an overvoltage fault (E. OV□) may occur. When this bus voltage rise is detected and the bus voltage level reaches or exceeds Pr. 883, increasing the frequency avoids the regeneration status.
- The regeneration avoidance function is always on when "1" is set in Pr. 882 and activated only during a constant speed when "2" is set in Pr. 882.

Regeneration avoidance operation example for acceleration

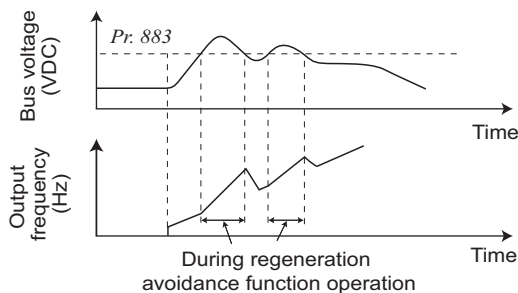

Regeneration avoidance operation example for constant speed

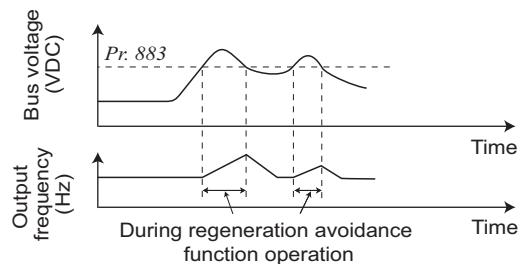

Regeneration avoidance operation example for deceleration

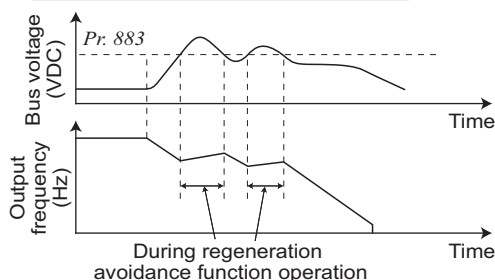

**REMARKS**

- The accel/decel ramp while the regeneration avoidance function is operating changes depending on the regeneration load.
- The DC bus voltage of the inverter is about  $\sqrt{2}$  times as input voltage.  
When the input voltage is 220VAC, bus voltage is approximately 311VDC.  
When the input voltage is 440VAC, bus voltage is approximately 622VDC.  
However, it varies with the input power supply waveform.
- The *Pr. 883* setting should be kept higher than the DC bus voltage level. Otherwise, the regeneration avoidance function is always on even in the non-regeneration status and the frequency increases.
- While overvoltage stall ( $\text{OL}$ ) is activated only during deceleration and stops the output frequency, the regeneration avoidance function is always on (*Pr. 882* = 1) or activated only during a constant speed (*Pr. 882* = 2) and increases the frequency according to the regeneration amount.

**(2) Limit regeneration avoidance operation frequency (*Pr. 885*)**

You can limit the output frequency compensated for (increased) by the regeneration avoidance function.

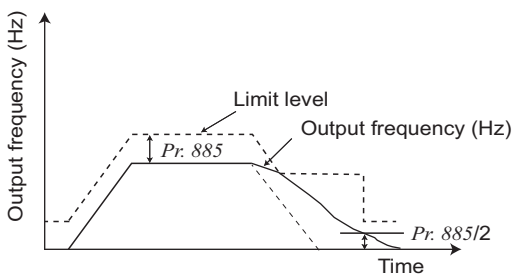

- The frequency is limited to the output frequency (frequency prior to regeneration avoidance operation) + *Pr. 885* Regeneration avoidance compensation frequency limit value during acceleration or constant speed. If the regeneration avoidance frequency exceeds the limit value during deceleration, the limit value is held until the output frequency falls to 1/2 of *Pr. 885*.
- When the frequency increased by regeneration avoidance function has reached *Pr. 1* Maximum frequency, it is limited to the maximum frequency.
- When *Pr. 885* is set to "9999", regeneration avoidance function operation frequency setting is invalid.

**(3) Regeneration avoidance function adjustment (*Pr. 665, Pr. 886*)**

- If the frequency becomes unstable during regeneration avoidance operation, decrease the setting of *Pr. 886* Regeneration avoidance voltage gain. Reversely, if sudden regeneration causes an overvoltage alarm, increase the setting.  
When vibration is not suppressed by decreasing the *Pr. 886* setting, set a smaller value in *Pr. 665* Regeneration avoidance frequency gain.

**NOTE**

- When regeneration avoidance operation is performed,  $\text{OL}$  (overvoltage stall) is displayed and the OL signal is output.
- When regeneration avoidance operation is performed, stall prevention is also activated at the same time.
- The regeneration avoidance function cannot shorten the actual deceleration time taken to stop the motor. The actual deceleration time depends on the regeneration energy consumption capability. When shortening the deceleration time, consider using the regeneration unit (FR-BU2, FR-CV, FR-HC) and brake resistor (MRS, MYS type and FR-ABR etc.) to consume regeneration energy at constant speed.
- When using the regeneration unit (FR-BU2, FR-CV, FR-HC) and brake resistor (MRS, MYS type, FR-ABR etc.), set *Pr. 882* to "0 (initial value)" (regeneration avoidance function invalid). When using the regeneration unit, etc. to consume regeneration energy at deceleration, set *Pr. 882* to "2" (regeneration avoidance function valid only at a constant speed).
- When regeneration avoidance operation is performed, the OL signal output item of *Pr. 156* also becomes the target of  $\text{OL}$  (overvoltage stall). *Pr. 157* OL signal output timer also becomes the target of  $\text{OL}$  (overvoltage stall).

**Parameters referred to**

*Pr. 1* Maximum frequency Refer to page 89

*Pr. 8* Deceleration time Refer to page 102

*Pr. 22* Stall prevention operation level Refer to page 85

## 4.22 Useful functions

Purpose	Parameter that should be Set		Refer to Page
Increase cooling fan life	Cooling fan operation selection	Pr. 244	250
To determine the maintenance time of parts.	Inverter part life display	Pr. 255 to Pr. 259	251
	Maintenance output function	Pr. 503, Pr. 504	255
	Current average value monitor signal	Pr. 555 to Pr. 557	256
Freely available parameter	Free parameter	Pr. 888, Pr. 889	258

### 4.22.1 Cooling fan operation selection (Pr. 244)

You can control the operation of the cooling fan (FR-E720-080 or more, FR-E740-040 or more) built in the inverter.

Parameter Number	Name	Initial Value	Setting Range	Description
244	Cooling fan operation selection	1	0	Operates in power-on status. Cooling fan on/off control invalid (the cooling fan is always on at power on)
			1	Cooling fan on/off control valid The fan is always on while the inverter is running. During a stop, the inverter status is monitored and the fan switches on-off according to the temperature.

The above parameters can be set when *Pr.160 User group read selection* = "0". (Refer to page 180)

- In either of the following cases, fan operation is regarded as faulty, [FN] is shown on the operation panel, and the fan fault (FAN) and alarm (LF) signals are output.
  - Pr. 244* = "0"  
When the fan comes to a stop with power on.
  - Pr. 244* = "1"  
When the inverter is running and the fan stops during fan ON command.
- For the terminal used for FAN signal output, set "25 (positive logic) or 125 (negative logic)" to any of *Pr. 190* to *Pr. 192* (*output terminal function selection*), and for the LF signal, set "98 (positive logic) or 198 (negative logic)".



#### NOTE

- Changing the terminal assignment using *Pr. 190* to *Pr. 192* (*output terminal function selection*) may affect the other functions. Make setting after confirming the function of each terminal.



#### Parameters referred to

*Pr.190* to *Pr.192* (*output terminal function selection*)  Refer to page 137

**4.22.2 Display of the life of the inverter parts (Pr. 255 to Pr. 259)**

Degrees of deterioration of main circuit capacitor, control circuit capacitor, cooling fan and inrush current limit circuit can be diagnosed by monitor.

When any part has approached the end of its life, an alarm can be output by self diagnosis to prevent a fault.

(Use the life check of this function as a guideline since the life except the main circuit capacitor is calculated theoretically.)

For the life check of the main circuit capacitor, the alarm signal (Y90) will not be output if a measuring method of (4) is not performed.

Parameter Number	Name	Initial Value	Setting Range	Description
255	Life alarm status display	0	(0 to 15)	Displays whether the control circuit capacitor, main circuit capacitor, cooling fan, and each parts of the inrush current limit circuit has reached the life alarm output level or not. (Reading only)
256	Inrush current limit circuit life display	100%	(0 to 100%)	Displays the deterioration degree of the inrush current limit circuit. (Reading only)
257	Control circuit capacitor life display	100%	(0 to 100%)	Displays the deterioration degree of the control circuit capacitor. (Reading only)
258	Main circuit capacitor life display	100%	(0 to 100%)	Displays the deterioration degree of the control circuit capacitor. (Reading only) The value measured by Pr. 259 is displayed.
259	Main circuit capacitor life measuring	0	0, 1 (2, 3, 8, 9)	Setting "1" and turning the power supply off starts the measurement of the main circuit capacitor life. When the Pr. 259 value is "3" after powering on again, the measuring is completed. Writes deterioration degree in Pr. 258.

The above parameters can be set when Pr. 160 User group read selection = "0". (Refer to page 180)

## (1) Life alarm display and signal output (Y90 signal, Pr. 255)

•Whether any of the control circuit capacitor, main circuit capacitor, cooling fan and inrush current limit circuit has reached the life alarm output level or not can be checked by Pr. 255 Life alarm status display and life alarm signal (Y90).

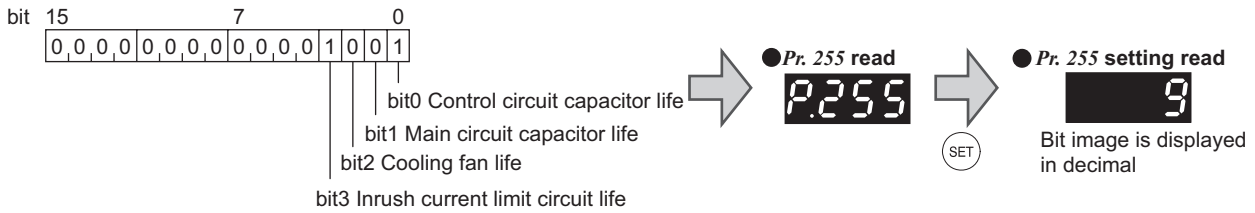

Pr. 255 (decimal)	Bit (binary)	Inrush Current Suppression Circuit Life	Cooling Fan Life	Main Circuit Capacitor Life	Control Circuit Capacitor Life
15	1111	○	○	○	○
14	1110	○	○	○	×
13	1101	○	○	×	○
12	1100	○	○	×	×
11	1011	○	×	○	○
10	1010	○	×	○	×
9	1001	○	×	×	○
8	1000	○	×	×	×
7	0111	×	○	○	○
6	0110	×	○	○	×
5	0101	×	○	×	○
4	0100	×	○	×	×
3	0011	×	×	○	○
2	0010	×	×	○	×
1	0001	×	×	×	○
0	0000	×	×	×	×

○: With warnings, ×: Without warnings

- The life alarm signal (Y90) turns on when any of the control circuit capacitor, main circuit capacitor, cooling fan and inrush current limit circuit reaches the life alarm output level.
- For the terminal used for the Y90 signal, set "90" (positive logic) or "190" (negative logic) to any of Pr. 190 to Pr. 192 (output terminal function selection).

### REMARKS

- When used with the option (FR-A7AY E kit, FR-A7AR E kit, FR-A7NC E kit), control circuit capacitor life signal (Y86), main circuit capacitor life signal (Y87), cooling fan life signal (Y88) and inrush current limit circuit life (Y89) can be output each.

### NOTE

- Changing the terminal assignment using Pr. 190 to Pr. 192 (output terminal function selection) may affect the other functions. Make setting after confirming the function of each terminal.

## (2) Inrush current limit circuit life display (Pr. 256)

- The life of the inrush current limit circuit (relay, contactor and inrush resistor) is displayed in Pr. 256 .
  - The number of contact (relay, contactor, thyristor) ON times is counted, and it is counted down from 100% (1 million times) every 1%/10,000 times.
- As soon as 10% (900,000 times) is reached, Pr. 255 bit 3 is turned on and also an alarm is output to the Y90 signal.

## (3) Control circuit capacitor life display (Pr. 257)

- The deterioration degree of the control circuit capacitor is displayed in Pr. 257 as a life.
  - In the operating status, the control circuit capacitor life is calculated from the energization time and temperature, and is counted down from 100%.
- As soon as the control circuit capacitor life falls below 10%, Pr. 255 bit 0 is turned on and also an alarm is output to the Y90 signal.

**(4) Main circuit capacitor life display (Pr. 258, Pr. 259)**

- The deterioration degree of the control circuit capacitor is displayed in Pr. 258 as a life.
- On the assumption that the main circuit capacitor capacitance at factory shipment is 100%, the capacitor life is displayed in Pr. 258 every time measurement is made.  
When the measured value falls to or below 85%, Pr. 255 bit 1 is turned on and also an alarm is output to the Y90 signal.
- Measure the capacitor capacity according to the following procedure and check the deterioration level of the capacitor capacity.
  - 1) Check that the motor is connected and at a stop.
  - 2) Set "1" (measuring start) in Pr. 259.
  - 3) Switch power off. The inverter applies DC voltage to the motor to measure the capacitor capacity while the inverter is off.
  - 4) After confirming that the LED of the operation panel is off, power on again.
  - 5) Check that "3" (measuring completion) is set in Pr. 259, read Pr. 258, and check the deterioration degree of the main circuit capacitor.

Pr. 259	Description	Remarks
0	No measurement	Initial value
1	Measurement start	Measurement starts when the power supply is switched off.
2	During measurement	Only displayed and cannot be set
3	Measurement complete	
8	Forced end	
9	Measurement error	

**REMARKS**

- When the main circuit capacitor life is measured under the following conditions, "forced end" (Pr. 259 = "8") or "measuring error" (Pr. 259 = "9") occurs or it remains in "measuring start" (Pr. 259 = "1"). Therefore, do not measure in such case.  
In addition, even when "measurement completion" (Pr. 259 = "3") is confirmed under the following conditions, normal measurement can not be done.
  - (a) FR-HC, FR-CV or FR-BU2 is connected.
  - (b) DC power supply is connected to the terminal P/+ and N/-.
  - (c) The power supply switched on during measurement.
  - (d) The motor is not connected to the inverter.
  - (e) The motor is running (coasting)
  - (f) The motor capacity is two rank smaller as compared to the inverter capacity.
  - (g) The inverter is tripped or a fault occurred when power is off.
  - (h) The inverter output is shut off with the MRS signal.
  - (i) The start command is given while measuring.
  - (j) The parameter unit (FR-PU04/FR-PU07) is connected.
  - (k) Use terminal PC as power supply.
  - (l) I/O terminal of the control terminal block and plug-in option is on (continuity).
  - (m) Plug-in option is fitted. (only for the FR-E720-050 or less, FR-E740-026 or less)
- Turning the power on during measuring before LED of the operation panel turns off, it may remain in "measuring" (Pr. 259 = "2") status. In such case, carry out operation from step 2.

**POINT**

For the accurate life measuring of the main circuit capacitor, perform after more than 3 hrs passed since the turn off of the power as it is affected by the capacitor temperature.

**WARNING**

**When measuring the main circuit capacitor capacity (Pr. 259 Main circuit capacitor life measuring = "1"), the DC voltage is applied to the motor for 1s at powering off. Never touch the motor terminal, etc. right after powering off to prevent an electric shock.**

### (5) Cooling fan life display

- The cooling fan speed of 50% or less is detected and "FN" is displayed on the operation panel and parameter unit (FR-PU04/FR-PU07). As an alarm display, Pr. 255 bit2 is turned on and also an alarm is output to the Y90 signal.



#### **REMARKS**

- When the inverter is mounted with two or more cooling fans, the life of even one cooling fan is diagnosed.



#### **NOTE**

- For replacement of each part, contact the nearest Mitsubishi FA center.



### 4.22.3 Maintenance timer alarm (Pr. 503, Pr. 504)

When the cumulative energization time of the inverter reaches the parameter set time, the maintenance timer output signal (Y95) is output.  (MT) is displayed on the operation panel.

This can be used as a guideline for the maintenance time of peripheral devices.

Parameter Number	Name	Initial Value	Setting Range	Description
503	Maintenance timer	0	0 (1 to 9998)	Displays the cumulative energization time of the inverter in 100h increments. (Reading only) Writing the setting of "0" clears the cumulative energization time.
504	Maintenance timer alarm output set time	9999	0 to 9998	Time taken until when the maintenance timer alarm output signal (Y95) is output.
			9999	No function

The above parameters can be set when Pr. 160 User group read selection = "0". (Refer to page 180)

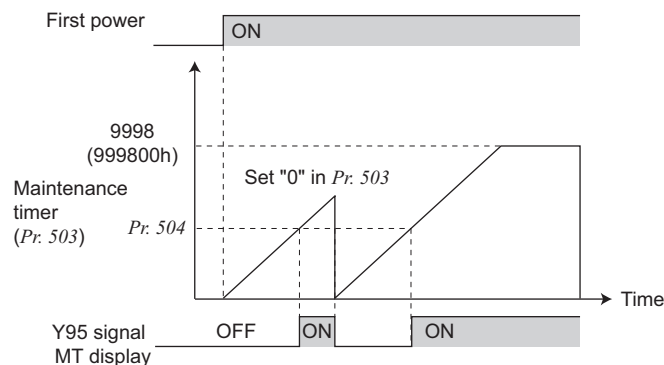

- The cumulative energization time of the inverter is stored into the EEPROM every hour and is displayed in Pr. 503 Maintenance timer in 100h increments. Pr. 503 is clamped at 9998 (999800h).
- When the Pr. 503 value reaches the time set to Pr. 504 Maintenance timer alarm output set time (100h increments), the maintenance timer alarm output signal (Y95) is output.
- For the terminal used for the Y95 signal output, assign the function by setting "95" (positive logic) or "195" (negative logic) to any of Pr. 190 to Pr. 192 (output terminal function selection).



#### NOTE

- The cumulative energization time is counted every hour. The energization time of less than 1h is not counted.
- Changing the terminal assignment using Pr. 190 to Pr. 192 (output terminal function selection) may affect the other functions. Make setting after confirming the function of each terminal.



#### Parameters referred to

Pr. 190 to Pr. 192 (output terminal function selection)  Refer to page 137

**4.22.4 Current average value monitor signal (Pr. 555 to Pr. 557)**

The average value of the output current during constant speed operation and the maintenance timer value are output as a pulse to the current average value monitor signal (Y93).

The pulse width output to the I/O module of the PLC or the like can be used as a guideline due to abrasion of machines and elongation of belt and for aged deterioration of devices to know the maintenance time. The current average value monitor signal (Y93) is output as pulse for 20s as 1 cycle and repeatedly output during constant speed operation.

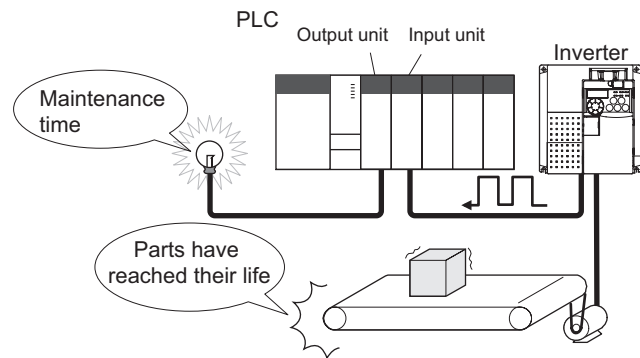

Parameter Number	Name	Initial Value	Setting Range	Description
555	Current average time	1s	0.1 to 1.0s	Time taken to average the current during start pulse output (1s).
556	Data output mask time	0s	0.0 to 20.0s	Time for not obtaining (mask) transient state data.
557	Current average value monitor signal output reference current	Rated inverter current	0 to 500A	Reference (100%) for outputting the signal of the current average value.

The above parameters can be set when Pr. 160 User group read selection = "0". (Refer to page 180)

The above parameters allow its setting to be changed during operation in any operation mode even if "0" (initial value) is set in Pr. 77 Parameter write selection.

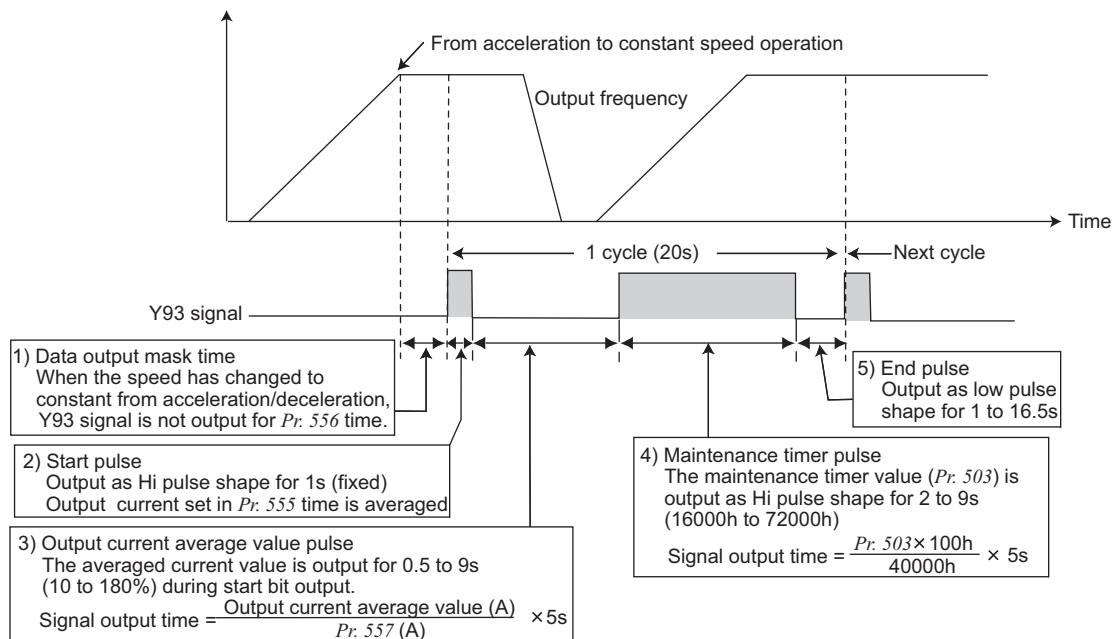

- The pulse output of the current average value monitor signal (Y93) is shown above.
- For the terminal used for the Y93 signal output, assign the function by setting "93" (positive logic) or "193" (negative logic) to any of Pr. 190 to Pr. 192 (output terminal function selection). The function can not be assigned to Pr.192 A,B,C terminal function selection.

1) Setting of Pr.556 Data output mask time

The output current is unstable (transient state) right after the operation is changed from the acceleration/deceleration state to the constant speed operation. Set the time for not obtaining (mask) transient state data in Pr.556.

2) Setting of Pr. 555 Current average time

The average output current is calculated during Hi output of start pulse (1s). Set the time taken to average the current during start bit output in Pr.555.

3) Setting of Pr.557 Current average value monitor signal output reference current

Set the reference (100%) for outputting the signal of the current average value. Obtain the time to output the signal from the following calculation.

$$\frac{\text{Output current average value}}{\text{Pr. 557 setting}} \times 5\text{s (Output current average value 100%/5s)}$$

Note that the output time range is 0.5 to 9s and the output time is either of the following values when the output current average value is the corresponding percentage of the Pr. 557 setting.

Less than 10% ... 0.5s, more than 180% ... 9s

Example) when Pr. 557 = 10A and the average value of output current is 15A

As  $15A/10A \times 5s=7.5$ , the current average value monitor signal is output as low pulse shape for 7.5s.

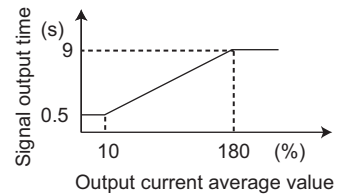

4) Setting of Pr. 503 Maintenance timer

After the output current average value is output as low pulse shape, the maintenance timer value is output as high pulse shape. The output time of the maintenance timer value is obtained from the following calculation.

$$\frac{\text{Pr. 503} \times 100}{40000\text{h}} \times 5\text{s (Maintenance timer value 100%/5s)}$$

Note that the output time range is 2 to 9s, and it is 2s when the Pr. 503 setting is less than 16000h and 9s when exceeds 72000h.

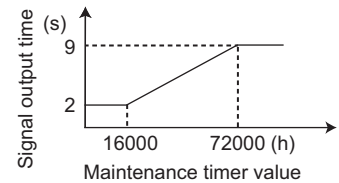

 **REMARKS**

- Mask of data output and sampling of output current are not performed during acceleration/deceleration.
- When the speed is changed to acceleration/deceleration from constant speed during start pulse output, the data is judged as invalid, the start pulse is output as high pulse shape for 3.5s, and the end signal is output as low pulse shape for 16.5s. The signal is output for at least 1 cycle even when acceleration/deceleration state continues after the start pulse output is completed.

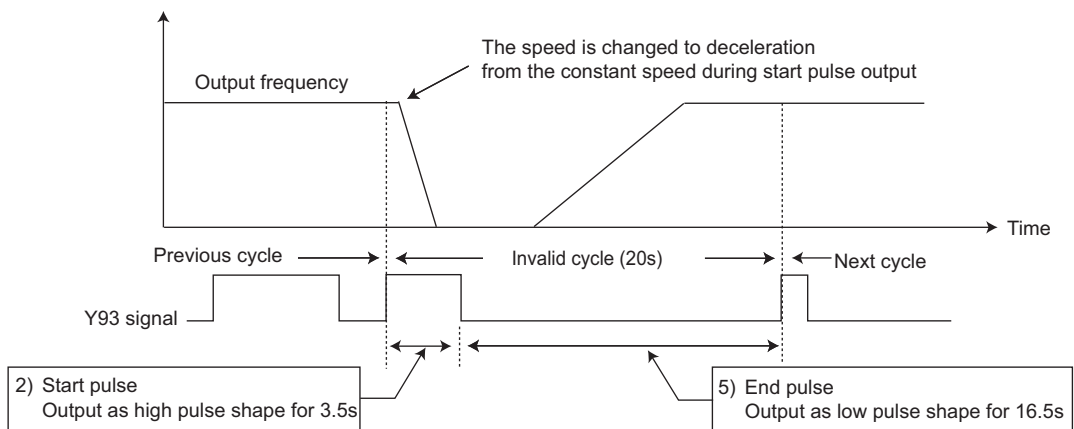



- When the output current value (inverter output current monitor) is 0A on completion of the 1 cycle signal output, the signal is not output until the speed becomes constant next time
- The current average value monitor signal (Y93) is output as low pulse shape for 20s (without data output) under the following condition.
  - (a) When the motor is in the acceleration/deceleration state on completion of the 1 cycle signal output
  - (b) When 1-cycle signal output was ended during restart operation with the setting of automatic restart after instantaneous power failure (Pr. 57 ≠ "9999")
  - (c) When restart operation was being performed at the point of data output mask end with the setting of automatic restart after instantaneous power failure (Pr. 57 ≠ "9999")

 **NOTE**

- Changing the terminal assignment using Pr.190 to Pr.192 (output terminal function selection) may affect the other functions. Make setting after confirming the function of each terminal.

 **Parameters referred to**

- Pr. 57 Restart coasting time  Refer to page 154
- Pr. 190 to Pr. 192 (output terminal function selection)  Refer to page 137
- Pr. 503 Maintenance timer  Refer to page 255

### 4.22.5 Free parameter (Pr. 888, Pr. 889)

You can input any number within the setting range 0 to 9999.

For example, the number can be used:

- As a unit number when multiple units are used.
- As a pattern number for each operation application when multiple units are used.
- As the year and month of introduction or inspection.

Parameter Number	Name	Initial Value	Setting Range	Description
888	Free parameter 1	9999	0 to 9999	Any values can be set. Data is held even if the inverter power is turned off.
889	Free parameter 2	9999	0 to 9999	

The above parameters can be set when *Pr. 160 User group read selection = "0"*. (Refer to page 180)

The above parameters allow its setting to be changed during operation in any operation mode even if "0" (initial value) is set in *Pr.77 Parameter write selection*.



#### REMARKS

*Pr. 888 and Pr. 889* do not influence the inverter operation.

## 4.23 Setting from the parameter unit and operation panel

Purpose	Parameter that should be Set		Refer to Page
Selection of rotation direction by  of the operation panel	RUN key rotation direction selection	Pr. 40	259
Switch the display language of the parameter unit	PU display language selection	Pr. 145	259
Use the setting dial of the operation panel like a potentiometer for frequency setting. Key lock of operation panel	Operation panel operation selection	Pr. 161	260
Change the magnitude of change of frequency setting by the setting dial of the operation panel	Magnitude of frequency change setting	Pr. 295	262
Control of the parameter unit buzzer	PU buzzer control	Pr. 990	263
Adjust LCD contrast of the parameter unit	PU contrast adjustment	Pr. 991	263

### 4.23.1 RUN key rotation direction selection (Pr. 40)

Used to choose the direction of rotation by operating  of the operation panel.

Parameter Number	Name	Initial Value	Setting Range	Description
40	RUN key rotation direction selection	0	0	Forward rotation
			1	Reverse rotation

The above parameters can be set when Pr. 160 User group read selection = "0". (Refer to page 180)

### 4.23.2 PU display language selection(Pr.145)

You can switch the display language of the parameter unit (FR-PU04/FR-PU07) to another.

Parameter Number	Name	Initial Value	Setting Range	Description
145	PU display language selection	1	0	Japanese
			1	English
			2	German
			3	French
			4	Spanish
			5	Italian
			6	Swedish
7	Finnish			

The above parameters can be set when Pr. 160 User group read selection = "0". (Refer to page 180)

### 4.23.3 Operation panel frequency setting/key lock operation selection (Pr. 161)





















The setting dial of the operation panel can be used for setting like a potentiometer.  
The key operation of the operation panel can be disabled.

Parameter Number	Name	Initial Value	Setting Range	Description
161	Frequency setting/key lock operation selection	0	0	Setting dial frequency setting mode Key lock mode invalid
			1	Setting dial potentiometer mode Key lock mode invalid
			10	Setting dial frequency setting mode Key lock mode valid
			11	Setting dial potentiometer mode Key lock mode valid

The above parameters can be set when Pr. 160 User group read selection = "0". (Refer to page 180)

#### (1) Using the setting dial like a potentiometer to set the frequency.

**Operation example** Changing the frequency from 0Hz to 60Hz during operation



Operation	Display
1. Screen at powering on The monitor display appears.	
2. Press  to choose the PU operation mode.	PU indication is lit. 
3. Press  to choose the parameter setting mode.	PRM indication is lit.  (The parameter number read previously appears.)
4. Turn  until P. 161 (Pr. 161) appears.	
5. Press  to read the currently set value. "0"(initial value) appears.	
6. Turn  to change it to the set value "1".	
7. Press  to set.	
8. Mode/monitor check Press  twice to choose the monitor/frequency monitor.	<b>Flicker Parameter setting complete!!</b> 
9. Press  to start the inverter.	
10. Turn  until "60.00" appears. The flickering frequency is the set frequency. You need not press  .	The frequency flickers for about 5s. 



#### REMARKS

- If the display changes from flickering "60.00" to "0.00", the setting of Pr. 161 Frequency setting/key lock operation selection may not be "1".
- Independently of whether the inverter is running or at a stop, the frequency can be set by merely turning the dial.
- When the frequency is changed, it will be stored in EEPROM as the set frequency after 10s.

**(2) Disable the setting dial and key operation of the operation panel (Press [MODE] long (2s))**

- Operation using the setting dial and key of the operation panel can be made invalid to prevent parameter change and unexpected start and stop.
- Set "10 or 11" in *Pr. 161*, then press  for 2s to make the setting dial and key operation invalid.
- When the setting dial and key operation is made invalid, *HOLD* appears on the operation panel. When the setting dial and key operation is invalid, *HOLD* appears if the setting dial or key operation is performed. (When the setting dial or key operation is not performed for 2s, the monitor display appears.)
- To make the setting dial and key operation valid again, press  for 2s.



**REMARKS**

- Even if the setting dial and key operation are disabled, the monitor display and  are valid.



**NOTE**

- Release the operation lock to release the PU stop by key operation.

### 4.23.4 Magnitude of frequency change setting (Pr. 295)

When setting the set frequency with the setting dial, frequency changes in 0.01Hz increments in the initial status. Setting this parameter increases the magnitude of frequency which changes according to the rotated amount of the setting dial, improving operability.

Parameter Number	Name	Initial Value	Setting Range	Description
295	Magnitude of frequency change setting	0	0	Function invalid
			0.01	The minimum varying width when the set frequency is changed by the setting dial can be set.
			0.10	
			1.00	
			10.00	

The above parameters can be set when Pr. 160 User group read selection = "0". (Refer to page 180)

#### (1) Basic operation

When a value other than "0" is set in Pr. 295, the minimum varying width when the set frequency is changed by the setting dial can be set.

For example, when "1.00Hz" is set in Pr. 295, one click (one dial gauge) of the setting dial changes the frequency in increments of 1.00Hz→2.00Hz→3.00Hz.

When Pr. 290 = "1"

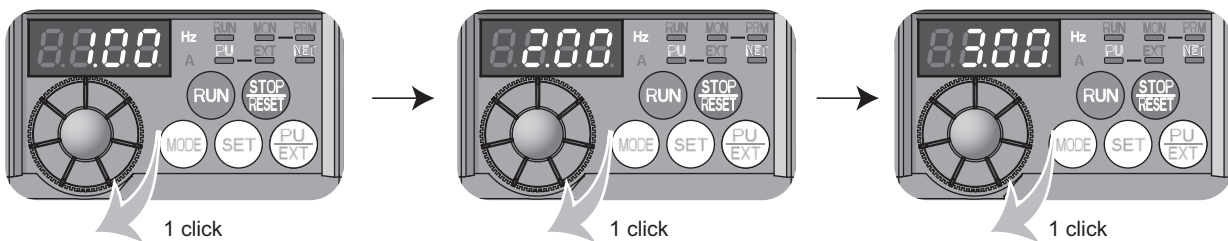

\*One rotation of the setting dial equals to 24 clicks (24 dial gauges).

#### REMARKS

- When machine speed display is selected with Pr. 37, the minimum increments of the magnitude of change is determined by Pr.295 as well. Note that the setting value may differ as speed setting changes the set machine speed and converts it to the speed display again.
- When the set frequency (speed) is 100 or more, frequency is displayed in 0.1 increments. Therefore, the minimum varying width is 0.1 even when Pr. 295 < 0.1.
- When the machine speed setting is 1000 or more, frequency is displayed in 1 increments. Therefore, the minimum varying width is 1 even when Pr. 295 < 1.

#### NOTE

- For Pr. 295, unit is not displayed.
- This parameter is valid only in the set frequency mode. When other frequency-related parameters are set, it is not activated.
- When 10 is set, frequency setting changes in 10Hz increments. Note the excess speed. (in potentiometer mode)



#### 4.23.5 Buzzer control (Pr. 990)

You can make the buzzer "beep" when you press the key of the parameter unit (FR-PU04/FR-PU07).

Parameter Number	Name	Initial Value	Setting Range	Description
990	PU buzzer control	1	0	Without buzzer
			1	With buzzer

The above parameters can be set when Pr. 160 User group read selection = "0". (Refer to page 180)

The above parameters allow its setting to be changed during operation in any operation mode even if "0" (initial value) is set in Pr. 77 Parameter write selection.

#### 4.23.6 PU contrast adjustment (Pr. 991)

Contrast adjustment of the LCD of the parameter unit (FR-PU04/FR-PU07) can be performed.  
Decreasing the setting value makes contrast light.

Parameter Number	Name	Initial Value	Setting Range	Description
991	PU contrast adjustment	58	0 to 63	0: Light ↓ 63: Dark

The above parameter is displayed as simple mode parameter only when the parameter unit FR-PU04/FR-PU07 is connected.

The above parameters allow its setting to be changed during operation in any operation mode even if "0" (initial value) is set in Pr. 77 Parameter write selection.

## 4.24 Parameter clear/ All parameter clear



### POINT

- Set "1" in *Pr.CL Parameter clear, ALLC all parameter clear* to initialize all parameters. (Parameters are not cleared when "1" is set in *Pr. 77 Parameter write selection*.)
- Refer to the extended parameter list on *page 54* for parameters cleared with this operation.

### Operation

1. Screen at powering on  
The monitor display appears.
2. Press to choose the PU operation mode.
3. Press to choose the parameter setting mode.
4. Turn until *Pr.CL (ALLC)* appears.
5. Press to read the currently set value.  
"0"(initial value) appears.
6. Turn to change it to the set value "1".
7. Press to set.

### Display



PU indication is lit.



PRM indication is lit.



(The parameter number read previously appears.)

Parameter clear



All parameter clear



Parameter clear



All parameter clear



Flicker ... Parameter setting complete!!

- Turn to read another parameter.
- Press to show the setting again.
- Press twice to show the next parameter.

Setting	Description
0	Not executed.
1	Return parameters to the initial values. (Parameter clear returns all parameters except <i>calibration parameters C0 (Pr. 900) to C7 (Pr. 905)</i> to the initial values.)



### REMARKS

? and are displayed alternately ... Why?

- The inverter is not in the PU operation mode.
- Is PU connector or USB connector used?

1. Press . [PU] is lit and the monitor (4 digit LED) displays "1". (When *Pr. 79* = "0" (initial value))
2. Carry out operation from step 6 again.

## 4.25 Initial value change list

Displays and sets the parameters changed from the initial value.

Operation	Display
1. Screen at powering on The monitor display appears.	
2. Press  to choose the PU operation mode.	PU indication is lit. 
3. Press  to choose the parameter setting mode.	PRM indication is lit.  (The parameter number read previously appears.)
4. Turn  until <i>P.r.C.H</i> appears.	
5. Pressing  changes to the initial value change list screen.	* It may take several seconds for creating the initial value change list. "P. ---" flickers while creating the list. 
6. Turning  displays the parameter number changed.	
• Press  to read the currently set value.	
Turn  and press  to change the setting (refer to step 6 and 7 on page 53)	
• Turn  to read another parameter.	
• The display returns to <i>P. ---</i> after all parameters are displayed.	
7. Pressing  in <i>P. ---</i> status returns to the parameter setting mode.	
• Turning  sets other parameters.	
• Pressing  displays the change list again.	



### NOTE

- Calibration parameters (C1 (Pr. 901) to C7 (Pr. 905)) are not displayed even they are changed from the initial settings.
- Only simple mode parameter is displayed when simple mode is set (Pr. 160 = 9999)
- Only user group is displayed when user group is set (Pr. 160 = "1").
- Pr. 160 is displayed independently of whether the setting value is changed or not.
- When parameter setting is changed after creating the initial value change list, the setting will be reflected to the initial value change list next time.



### Parameters referred to

Pr. 160 User group read selection Refer to page 180

C1 (Pr. 901) AM terminal calibration Refer to page 152

C2(Pr. 902) to C7(Pr. 905) (Frequency setting bias/gain parameter) Refer to page 171

## 4.26 Check and clear of the faults history

### (1) Check for the faults history

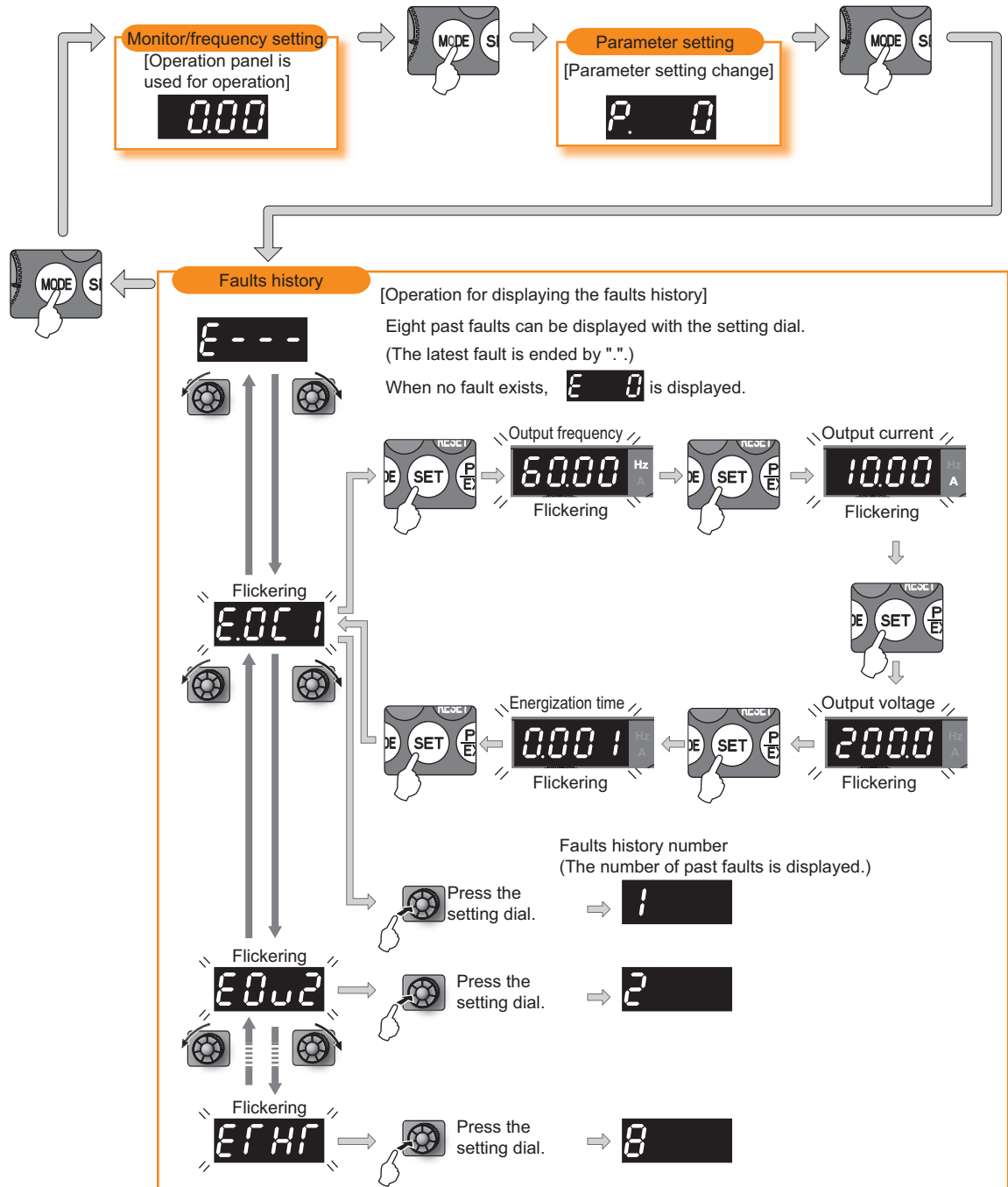





(2) Clearing procedure





**POINT**

- Set "1" in *Er.CL Fault history clear* to clear the faults history.

Operation

1. Screen at powering on  
The monitor display appears.
2. Press  to choose the parameter setting mode.
3. Turn  until *Er.CL* (faults history clear) appears.
4. Press  to read the currently set value. "0" (initial value) appears.
5. Turn  to change it to the set value "1".
6. Press  to set.

- Turn  to read another parameter.
- Press  to show the setting again.
- Press  twice to show the next parameter.



**Parameters referred to**

Pr. 77 Parameter write selection  Refer to page 179

Display



PRM indication is lit.



⇒ (The parameter number read previously appears.)



Flicker...Faults history clear complete!!

# MEMO

# 5 TROUBLESHOOTING

---

This chapter provides the "TROUBLESHOOTING" of this product.

Always read the instructions before using the equipment

---

5.1	Reset method of protective function .....	270
5.2	List of fault or alarm indications .....	271
5.3	Causes and corrective actions .....	272
5.4	Correspondences between digital and actual characters .....	280
5.5	Check first when you have some troubles .....	281

1

2

3

4

5

6

7

## **Reset method of protective function**

When a fault occurs in the inverter, the inverter trips and the PU display automatically changes to any of the following fault or alarm indications.

If the fault does not correspond to any of the following faults or if you have any other problem, please contact your sales representative.

- Retention of fault output signal...When the magnetic contactor (MC) provided on the input side of the inverter is opened when a fault occurs, the inverter's control power will be lost and the fault output will not be held.
- Fault or alarm indication .....When a fault or alarm occurs, the operation panel display automatically switches to the fault or alarm indication.
- Resetting method .....When a fault occurs, the inverter output is kept stopped. Unless reset, therefore, the inverter cannot restart. (Refer to page 270)
- When any fault occurs, take the appropriate corrective action, then reset the inverter, and resume operation. Not doing so may lead to the inverter fault and damage.

Inverter fault or alarm indications are roughly divided as below.

- (1) Error message  
A message regarding operational fault and setting fault by the operation panel and parameter unit (FR-PU04 /FR-PU07) is displayed. The inverter does not trip.
- (2) Warnings  
The inverter does not trip even when a warning is displayed. However, failure to take appropriate measures will lead to a fault.
- (3) Alarm  
The inverter does not trip. You can also output an alarm signal by making parameter setting.
- (4) Fault  
When a fault occurs, the inverter trips and a fault signal is output.

### **5.1 Reset method of protective function**

#### (1) Resetting the inverter

The inverter can be reset by performing any of the following operations. Note that the internal thermal integrated value of the electronic thermal relay function and the number of retries are cleared (erased) by resetting the inverter.

Recover about 1s after reset is cancelled.

Operation 1: ..... Using the operation panel, press  to reset the inverter.

(This may only be performed when a fault occurs (Refer to page 275 for fault.))

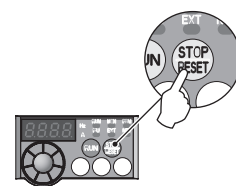

Operation 2: ..... Switch power off once, then switch it on again.

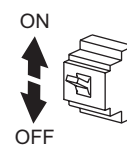

Operation 3: ..... Turn on the reset signal (RES) for more than 0.1s. (If the RES signal is kept on, "Err." appears (flickers) to indicate that the inverter is in a reset status.)

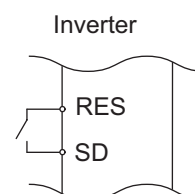



## 5.2 List of fault or alarm indications



Operation Panel Indication		Name	Refer to Page		
Error message	E---	E---	Faults history	266	
	HOLD	HOLD	Operation panel lock	272	
	Er 1 to Er 4	Er1 to 4	Parameter write error	272	
	Err.	Err.	Inverter reset	272	
Warnings	OL	OL	Stall prevention (overcurrent)	273	
	oL	oL	Stall prevention (overvoltage)	273	
	rb	RB	Regenerative brake prealarm	274	
	TH	TH	Electronic thermal relay function prealarm	274	
	PS	PS	PU stop	273	
	MT	MT	Maintenance signal output	274	
	UV	UV	Undervoltage	274	
Alarm	F <sub>n</sub>	FN	Fan alarm	274	
Fault	E.OC1	E.OC1	Overcurrent trip during acceleration	275	
	E.OC2	E.OC2	Overcurrent trip during constant speed	275	
	E.OC3	E.OC3	Overcurrent trip during deceleration or stop	275	
	E.OV1	E.OV1	Regenerative overvoltage trip during acceleration	275	
	E.OV2	E.OV2	Regenerative overvoltage trip during constant speed	276	
	E.OV3	E.OV3	Regenerative overvoltage trip during deceleration or stop	276	
	E.THT	E.THT	Inverter overload trip (electronic thermal relay function)	276	
	E.THM	E.THM	Motor overload trip (electronic thermal relay function)	276	
	E.FIN	E.FIN	Fin overheat	277	
	Fault	EILF	E.ILF *	Input phase loss	277
		E.OLT	E.OLT	Stall prevention	277
E. bE		E. BE	Brake transistor alarm detection	277	
E. GF		E.GF	Output side earth (ground) fault overcurrent at start	277	
E. LF		E.LF	Output phase loss	278	
E.OHT		E.OHT	External thermal relay operation	278	
E.OP1		E.OP1	Communication option fault	278	
E. 1		E. 1	Option fault	278	
E. PE		E.PE	Parameter storage device fault	278	
EPE2		E.PE2 *	Internal board fault	279	
E.PUE		E.PUE	PU disconnection	279	
E. rET		E.RET	Retry count excess	279	
E. 6/ E. 7/ E.CPU		E. 6/ E. 7/ E.CPU	CPU fault	279	
E.IOH		E.IOH *	Inrush current limit circuit fault	279	
E.AIE	E.AIE *	Analog input fault	280		
E.USB	E. USB *	USB communication fault	280		
E.MB4 to E.MB7	E.MB4 to E.MB7	Brake sequence fault	279		
E. 13	E.13	Internal circuit fault	280		

\* If a fault occurs when using with the FR-PU04, "Fault 14" is displayed on the FR-PU04.

### 5.3 Causes and corrective actions

(1) Error message

A message regarding operational troubles is displayed. Output is not shutoff.

Operation panel indication	HOLD	HOLD
Name	Operation panel lock	
Description	Operation lock mode is set. Operation other than  is made invalid. (Refer to page 261)	
Check point	—	
Corrective action	Press  for 2s to release lock.	

Operation panel indication	Er1	Er1
Name	Write disable error	
Description	<ol style="list-style-type: none"> <li>1. You attempted to make parameter setting when Pr. 77 Parameter write selection has been set to disable parameter write.</li> <li>2. Frequency jump setting range overlapped.</li> <li>3. The PU and inverter cannot make normal communication.</li> </ol>	
Check point	<ol style="list-style-type: none"> <li>1. Check the setting of Pr. 77 Parameter write selection. (Refer to page 179).</li> <li>2. Check the settings of Pr. 31 to Pr. 36 (frequency jump). (Refer to page 90)</li> <li>3. Check the connection of the PU and inverter.</li> </ol>	

Operation panel indication	Er2	Er2
Name	Write error during operation	
Description	When parameter write was performed during operation with a value other than "2" (writing is enabled independently of operation status in any operation mode) is set in Pr. 77 and the STF (STR) is on.	
Check point	<ol style="list-style-type: none"> <li>1. Check the Pr. 77 setting. (Refer to page 179).</li> <li>2. Check that the inverter is not operating.</li> </ol>	
Corrective action	<ol style="list-style-type: none"> <li>1. Set "2" in Pr. 77.</li> <li>2. After stopping operation, make parameter setting.</li> </ol>	

Operation panel indication	Er3	Er3
Name	Calibration error	
Description	Analog input bias and gain calibration values are too close.	
Check point	Check the settings of C3, C4, C6 and C7 (calibration functions). (Refer to page 171).	

Operation panel indication	Er4	Er4
Name	Mode designation error	
Description	You attempted to make parameter setting in the NET operation mode when Pr. 77 is not 2.	
Check point	<ol style="list-style-type: none"> <li>1. Check that operation mode is PU operation mode.</li> <li>2. Check the Pr. 77 setting. (Refer to page 179).</li> </ol>	
Corrective action	<ol style="list-style-type: none"> <li>1. After setting the operation mode to the "PU operation mode", make parameter setting. (Refer to page 183)</li> <li>2. After setting "2" in Pr. 77, make parameter setting.</li> </ol>	





Operation panel indication	Err.	Err.
Name	Inverter reset	
Description	<ul style="list-style-type: none"> <li>• Executing reset using RES signal, or reset command from communication or PU</li> <li>• Displays at powering off.</li> </ul>	
Corrective action	<ul style="list-style-type: none"> <li>• Turn off the reset command</li> </ul>	

(2) Warnings

When a warning occurs, the output is not shut off.

Operation panel indication	OL		FR-PU04 FR-PU07	OL
<b>Name</b>	Stall prevention (overcurrent)			
<b>Description</b>	During acceleration	When the output current (output torque when <i>Pr. 277 Stall prevention current switchover</i> = "1") of the inverter exceeds the stall prevention operation level ( <i>Pr. 22 Stall prevention operation level</i> , etc.), this function stops the increase in frequency until the overload current decreases to prevent the inverter from resulting in overcurrent trip. When the overload current has reduced below stall prevention operation level, this function increases the frequency again.		
	During constant-speed operation	When the output current (output torque when <i>Pr. 277 Stall prevention current switchover</i> = "1") of the inverter exceeds the stall prevention operation level ( <i>Pr. 22 Stall prevention operation level</i> , etc.), this function reduces frequency until the overload current decreases to prevent the inverter from resulting in overcurrent trip. When the overload current has reduced below stall prevention operation level, this function increases the frequency up to the set value.		
	During deceleration	When the output current (output torque when <i>Pr. 277 Stall prevention current switchover</i> = "1") of the inverter exceeds the stall prevention operation level ( <i>Pr. 22 Stall prevention operation level</i> , etc.), this function stops the decrease in frequency until the overload current decreases to prevent the inverter from resulting in overcurrent trip. When the overload current has decreased below stall prevention operation level, this function decreases the frequency again.		
<b>Check point</b>	<ol style="list-style-type: none"> <li>1. Check that the <i>Pr. 0 Torque boost</i> setting is not too large.</li> <li>2. Check that the <i>Pr. 7 Acceleration time</i> and <i>Pr. 8 Deceleration time</i> settings are not too small.</li> <li>3. Check that the load is not too heavy.</li> <li>4. Are there any failure in peripheral devices?</li> <li>5. Check that the <i>Pr. 13 Start frequency</i> is not too large.</li> <li>6. Check that the <i>Pr. 22 Stall prevention operation level</i> is appropriate</li> </ol>			
<b>Corrective action</b>	<ol style="list-style-type: none"> <li>1. Increase or decrease the <i>Pr. 0 Torque boost</i> setting 1% by 1% and check the motor status. (<i>Refer to page 77</i>)</li> <li>2. Set a larger value in <i>Pr. 7 Acceleration time</i> and <i>Pr. 8 Deceleration time</i>. (<i>Refer to page 102</i>)</li> <li>3. Reduce the load weight.</li> <li>4. Try advanced magnetic flux vector control and general-purpose magnetic flux vector control.</li> <li>5. Change the <i>Pr. 14 Load pattern selection</i> setting.</li> <li>6. Set stall prevention operation current in <i>Pr. 22 Stall prevention operation level</i>. (The initial value is 150%.) The acceleration/deceleration time may change. Increase the stall prevention operation level with <i>Pr. 22 Stall prevention operation level</i>, or disable stall prevention with <i>Pr. 156 Stall prevention function selection</i>. (Operation at OL occurrence can be selected using <i>Pr. 156</i>.)</li> </ol>			



Operation panel indication	oL		FR-PU04 FR-PU07	oL
<b>Name</b>	Stall prevention (overvoltage)			
<b>Description</b>	During deceleration	<ul style="list-style-type: none"> <li>• If the regenerative energy of the motor becomes excessive to exceed the regenerative energy consumption capability, this function stops the decrease in frequency to prevent overvoltage trip. As soon as the regenerative energy has reduced, deceleration resumes.</li> <li>• If the regenerative energy of the motor becomes excessive when regeneration avoidance function is selected (<i>Pr. 882</i> =1), this function increases the speed to prevent overvoltage trip. (<i>Refer to page 248</i>).</li> </ul>		
		<ul style="list-style-type: none"> <li>• Check for sudden speed reduction.</li> <li>• Check that regeneration avoidance function (<i>Pr. 882</i>, <i>Pr. 883</i>, <i>Pr. 885</i>, <i>Pr. 886</i>) is used. (<i>Refer to page 248</i>).</li> </ul>		
<b>Check point</b>				
<b>Corrective action</b>	The deceleration time may change. Increase the deceleration time using <i>Pr. 8 Deceleration time</i> .			

Operation panel indication	PS		FR-PU04 FR-PU07	PS
<b>Name</b>	PU stop			
<b>Description</b>	Stop with  of the PU is set in <i>Pr. 75 Reset selection/disconnected PU detection/PU stop selection</i> . (For <i>Pr. 75</i> refer to <i>page 176</i> .)			
<b>Check point</b>	Check for a stop made by pressing  of the operation panel.			
<b>Corrective action</b>	Turn the start signal off and release with  .			

Operation panel indication	RB		FR-PU04 FR-PU07	RB
Name	Regenerative brake prealarm			
Description	Appears if the regenerative brake duty reaches or exceeds 85% of the <i>Pr. 70 Special regenerative brake duty</i> value. When the setting of <i>Pr. 70 Special regenerative brake duty</i> is the initial value ( <i>Pr. 70 = "0"</i> ), this warning does not occur. If the regenerative brake duty reaches 100%, a regenerative overvoltage (E. OV_) occurs. The RBP signal can be simultaneously output with the [RB] display. For the terminal used for the RBP signal output, assign the function by setting "7 (positive logic) or 107 (negative logic)" in any of <i>Pr. 190 to Pr. 192 (output terminal function selection)</i> . (Refer to page 137).			
Check point	1. Check that the brake resistor duty is not high. 2. Check that the <i>Pr. 30 Regenerative function selection</i> and <i>Pr. 70 Special regenerative brake duty</i> settings are correct.			
Corrective action	1. Increase the deceleration time. 2. Check that the <i>Pr. 30 Regenerative function selection</i> and <i>Pr. 70 Special regenerative brake duty</i> settings.			



Operation panel indication	TH		FR-PU04 FR-PU07	TH
Name	Electronic thermal relay function prealarm			
Description	Appears if the cumulative value of the <i>Pr. 9 Electronic thermal O/L relay</i> reaches or exceeds 85% of the preset level. If it reaches 100% of the <i>Pr. 9 Electronic thermal O/L relay</i> setting, a motor overload trip (E. THM) occurs. The THP signal can be simultaneously output with the [TH] display. For the terminal used for THP signal output, assign the function by setting "8 (positive logic) or 108 (negative logic)" in any of <i>Pr. 190 to Pr. 192 (output terminal function selection)</i> . (Refer to page 137).			
Check point	1. Check for large load or sudden acceleration. 2. Is the <i>Pr. 9 Electronic thermal O/L relay</i> setting is appropriate? (Refer to page 109)			
Corrective action	1. Reduce the load and frequency of operation. 2. Set an appropriate value in <i>Pr. 9 Electronic thermal O/L relay</i> . (Refer to page 109)			

Operation panel indication	MT		FR-PU04 FR-PU07	— MT
Name	Maintenance signal output			
Description	Indicates that the cumulative energization time of the inverter has reached a given time. When the setting of <i>Pr. 504 Maintenance timer alarm output set time</i> is the initial value ( <i>Pr. 504 = "9999"</i> ), this warning does not occur.			
Check point	The <i>Pr. 503 Maintenance timer</i> setting is larger than the <i>Pr. 504 Maintenance timer alarm output set time</i> setting. (Refer to page 255).			
Corrective action	Setting "0" in <i>Pr. 503 Maintenance timer</i> erases the signal.			

Operation panel indication	UV		FR-PU04 FR-PU07	—
Name	Undervoltage			
Description	If the power supply voltage of the inverter decreases, the control circuit will not perform normal functions. In addition, the motor torque will be insufficient and/or heat generation will increase. To prevent this, if the power supply voltage decreases below about 115VAC (230VAC for 400V class), this function stops the inverter output and displays  . An alarm is reset when the voltage returns to normal.			
Check point	Check that the power supply voltage is normal.			
Corrective action	Check the power supply system equipment such as power supply.			

### (3) Alarm

When an alarm occurs, the output is not shut off. You can also output an alarm signal by making parameter setting. (Set "98" in any of *Pr. 190 to Pr. 192 (output terminal function selection)*. Refer to page 137).

Operation panel indication	FN		FR-PU04 FR-PU07	FN
Name	Fan alarm			
Description	For the inverter that contains a cooling fan,  appears on the operation panel when the cooling fan stops due to an alarm or different operation from the setting of <i>Pr. 244 Cooling fan operation selection</i> .			
Check point	Check the cooling fan for an alarm.			
Corrective action	Check for fan alarm. Please contact your sales representative.			

(4) Fault

When a fault occurs, the inverter trips and a fault signal is output.

Operation panel indication	E.OC1		FR-PU04 FR-PU07	OC During Acc
Name	Overcurrent trip during acceleration			
Description	When the inverter output current reaches or exceeds approximately 230% of the rated current during acceleration, the protective circuit is activated and the inverter trips.			
Check point	<ol style="list-style-type: none"> <li>1. Check for sudden acceleration.</li> <li>2. Check that the downward acceleration time is not long in vertical lift application.</li> <li>3. Check for output short-circuit/ground fault.</li> <li>4. Check that the <i>Pr. 3 Base frequency</i> setting is not 60Hz when the motor rated frequency is 50Hz.</li> <li>5. Check that stall prevention operation is appropriate.</li> <li>6. Check that regeneration is not performed frequently. (Check that the output voltage becomes larger than the V/F reference value at regeneration and overcurrent occurs due to the high voltage.)</li> </ol>			
Corrective action	<ol style="list-style-type: none"> <li>1. Increase the acceleration time. (Shorten the downward acceleration time in vertical lift application.</li> <li>2. When "E.OC1" is always lit at starting, disconnect the motor once and start the inverter. If "E.OC1" is still lit, contact your sales representative.</li> <li>3. Check the wiring to make sure that output short circuit/ground fault does not occur.</li> <li>4. Set 50Hz in <i>Pr. 3 Base frequency</i>. (Refer to page 91)</li> <li>5. Perform stall prevention operation appropriately. (Refer to page 85).</li> <li>6. Set base voltage (rated voltage of the motor, etc.) in <i>Pr. 19 Base frequency voltage</i>. (Refer to page 91)</li> </ol>			

Operation panel indication	E.OC2		FR-PU04 FR-PU07	Stedy Spd OC
Name	Overcurrent trip during constant speed			
Description	When the inverter output current reaches or exceeds approximately 230% of the rated current during constant speed operation, the protective circuit is activated and the inverter trips.			
Check point	<ol style="list-style-type: none"> <li>1. Check for sudden load change.</li> <li>2. Check for output short-circuit/ground fault.</li> <li>3. Check that stall prevention operation is appropriate.</li> </ol>			
Corrective action	<ol style="list-style-type: none"> <li>1. Keep load stable.</li> <li>2. Check the wiring to make sure that output short circuit/ground fault does not occur.</li> <li>3. Perform stall prevention operation appropriately. (Refer to page 85).</li> </ol>			

Operation panel indication	E.OC3		FR-PU04 FR-PU07	OC During Dec
Name	Overcurrent trip during deceleration or stop			
Description	When the inverter output current reaches or exceeds approximately 230% of the rated inverter current during deceleration (other than acceleration or constant speed), the protective circuit is activated and the inverter trips.			
Check point	<ol style="list-style-type: none"> <li>1. Check for sudden speed reduction.</li> <li>2. Check for output short-circuit/ground fault.</li> <li>3. Check for too fast operation of the motor's mechanical brake.</li> <li>4. Check that stall prevention operation is appropriate.</li> </ol>			
Corrective action	<ol style="list-style-type: none"> <li>1. Increase the deceleration time.</li> <li>2. Check the wiring to make sure that output short circuit/ground fault does not occur.</li> <li>3. Check the mechanical brake operation.</li> <li>4. Perform stall prevention operation appropriately. (Refer to page 85).</li> </ol>			

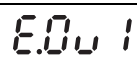
Operation panel indication	E.OV1		FR-PU04 FR-PU07	OV During Acc
Name	Regenerative overvoltage trip during acceleration			
Description	If regenerative energy causes the inverter's internal main circuit DC voltage to reach or exceed the specified value, the protective circuit is activated and the inverter trips. The circuit may also be activated by a surge voltage produced in the power supply system.			
Check point	<ol style="list-style-type: none"> <li>1. Check for too slow acceleration. (e.g. during downward acceleration in vertical lift load)</li> <li>2. Check that the <i>Pr. 22 Stall prevention operation level</i> is not lower than the no load current.</li> </ol>			
Corrective action	<ol style="list-style-type: none"> <li>1. • Decrease the acceleration time. <ul style="list-style-type: none"> <li>• Check that regeneration avoidance function (<i>Pr. 882, Pr. 883, Pr. 885, Pr. 886</i>) is used. (Refer to page 248).</li> </ul> </li> <li>2. Set a value larger than the no load current in <i>Pr. 22 Stall prevention operation level</i>.</li> </ol>			

Operation panel indication	E.OV2		FR-PU04 FR-PU07	Stedy Spd OV
Name	Regenerative overvoltage trip during constant speed			
Description	If regenerative energy causes the inverter's internal main circuit DC voltage to reach or exceed the specified value, the protective circuit is activated to stop the inverter output. The circuit may also be activated by a surge voltage produced in the power supply system.			
Check point	1. Check for sudden load change. 2. Check that the <i>Pr. 22 Stall prevention operation level</i> is not lower than the no load current.			
Corrective action	1. • Keep load stable. • Check that regeneration avoidance function ( <i>Pr. 882, Pr. 883, Pr. 885, Pr. 886</i> ) is used. ( <i>Refer to page 248</i> ). • Use the brake resistor, brake unit or power regeneration common converter (FR-CV) as required. 2. Set a value larger than the no load current in <i>Pr. 22 Stall prevention operation level</i> .			

Operation panel indication	E.OV3		FR-PU04 FR-PU07	OV During Dec
Name	Regenerative overvoltage trip during deceleration or stop			
Description	If regenerative energy causes the inverter's internal main circuit DC voltage to reach or exceed the specified value, the protective circuit is activated to stop the inverter output. The circuit may also be activated by a surge voltage produced in the power supply system.			
Check point	Check for sudden speed reduction.			
Corrective action	<ul style="list-style-type: none"> <li>• Increase the deceleration time. (Set the deceleration time which matches the moment of inertia of the load)</li> <li>• Longer the brake cycle.</li> <li>• Use regeneration avoidance function (<i>Pr. 882, Pr. 883, Pr. 885, Pr. 886</i>). (<i>Refer to page 248</i>).</li> <li>• Use the brake resistor, brake unit or power regeneration common converter (FR-CV) as required.</li> </ul>			

Operation panel indication	E.THT		FR-PU04 FR-PU07	Inv. Overload
Name	Inverter overload trip (electronic thermal relay function)			
Description	If the temperature of the output transistor element exceeds the protection level under the condition that a current not less than the rated inverter current flows and overcurrent trip does not occur (230% or less), the electronic thermal relay activates to stop the inverter output. (Overload capacity 150% 60s, 200% 3s, inverse-time characteristic)			
Check point	1. Check the motor for use under overload. 2. Check for too high ambient temperature.			
Corrective action	1. Reduce the load weight. 2. Set the ambient temperature to within the specifications.			

Operation panel indication	E.THM		FR-PU04 FR-PU07	Motor Ovrload
Name	Motor overload trip (electronic thermal relay function) *1			
Description	The electronic thermal relay function in the inverter detects motor overheat due to overload or reduced cooling capability during constant-speed operation and pre-alarm (TH display) is output when the $I^2t$ value reaches 85% of the <i>Pr. 9 Electronic thermal O/L relay</i> setting and the protection circuit is activated to stop the inverter output when the $I^2t$ value reaches the specified value. When running a special motor such as a multi-pole motor or multiple motors, provide a thermal relay on the inverter output side since such motor(s) cannot be protected by the electronic thermal relay function.			
Check point	1. Check the motor for use under overload. 2. Check that the setting of <i>Pr. 71 Applied motor</i> for motor selection is correct. ( <i>Refer to page 111</i> ). 3. Check that stall prevention operation setting is correct.			
Corrective action	1. Reduce the load weight. 2. For a constant-torque motor, set the constant-torque motor in <i>Pr. 71 Applied motor</i> . 3. Check that stall prevention operation setting is correct. ( <i>Refer to page 85</i> ).			

\*1 Resetting the inverter initializes the internal thermal integrated data of the electronic thermal relay function.

Operation panel indication	E.FIN	<i>E.FIN</i>	FR-PU04 FR-PU07	H/Sink O/Temp
Name	Fin overheat			
Description	<p>If the heatsink overheats, the temperature sensor is actuated and the inverter trips.</p> <p>The FIN signal can be output when the temperature becomes approximately 85% of the heatsink overheat protection operation temperature.</p> <p>For the terminal used for the FIN signal output, assign the function by setting "26 (positive logic) or 126 (negative logic)" in any of Pr. 190 to Pr. 192 (output terminal function selection). (Refer to page 137).</p>			
Check point	<ol style="list-style-type: none"> <li>1. Check for too high ambient temperature.</li> <li>2. Check for heatsink clogging.</li> <li>3. Check that the cooling fan is not stopped (Check that <i>F<sub>rn</sub></i> is not displayed on the operation panel).</li> </ol>			
Corrective action	<ol style="list-style-type: none"> <li>1. Set the ambient temperature to within the specifications.</li> <li>2. Clean the heatsink.</li> <li>3. Replace the cooling fan.</li> </ol>			

Operation panel indication	E.ILF	<i>E.ILF</i>	FR-PU04 FR-PU07	Fault 14 Input phase loss
Name	Input phase loss			
Description	<p>This fault is output when function valid setting (=1) is set in Pr. 872 Input phase loss protection selection and one phase of the three phase power input is lost. (Refer to page 164).</p>			
Check point	Check for a break in the cable for the three-phase power supply input.			
Corrective action	<ul style="list-style-type: none"> <li>• Wire the cables properly.</li> <li>• Repair a brake portion in the cable.</li> <li>• Check the Pr. 872 Input phase loss protection selection setting.</li> </ul>			

Operation panel indication	E.OLT	<i>E.OLT</i>	FR-PU04 FR-PU07	Stll Prev STP (OL shown during stall prevention operation)
Name	Stall prevention			
Description	<p>If the output frequency has fallen to 1Hz by stall prevention operation and remains for 3s, a fault (E.OLT) appears and trips the inverter. OL appears while stall prevention is being activated.</p>			
Check point	<ul style="list-style-type: none"> <li>• Check the motor for use under overload. (Refer to page 86).</li> </ul>			
Corrective action	<ul style="list-style-type: none"> <li>• Reduce the load weight. Check the Pr. 22 Stall prevention operation level setting.</li> </ul>			

Operation panel indication	E.BE	<i>E. bE</i>	FR-PU04 FR-PU07	Br. Cct. Fault
Name	Brake transistor alarm detection			
Description	<p>When a brake transistor alarm has occurred due to the large regenerative energy from the motor etc., the brake transistor alarm is detected and the inverter trips.</p> <p><u>In this case, the inverter must be powered off immediately.</u></p>			
Check point	<ul style="list-style-type: none"> <li>• Reduce the load inertia.</li> <li>• Check that the frequency of using the brake is proper.</li> </ul>			
Corrective action	Replace the inverter.			

Operation panel indication	E.GF	<i>E. GF</i>	FR-PU04 FR-PU07	Ground Fault
Name	Output side earth (ground) fault overcurrent at start			
Description	<p>The inverter trips if an earth (ground) fault overcurrent flows at start due to an earth (ground) fault that occurred on the inverter's output side (load side). Whether this protective function is used or not is set with Pr. 249 Earth (ground) fault detection at start. When the setting of Pr. 249 Earth (ground) fault detection at start is the initial value (Pr. 249 = "0"), this warning does not occur.</p>			
Check point	Check for a ground fault in the motor and connection cable.			
Corrective action	Remedy the ground fault portion.			

## 7 Causes and corrective actions

Operation panel indication	E.LF	<b>E. LF</b>	FR-PU04 FR-PU07	E.LF
Name	Output phase loss			
Description	This function stops the inverter output if one of the three phases (U, V, W) on the inverter's output side (load side) is lost. Whether the protective function is used or not is set with <i>Pr. 251 Output phase loss protection selection</i> .			
Check point	<ul style="list-style-type: none"> <li>Check the wiring. (Check that the motor is normal.)</li> <li>Check that the capacity of the motor used is not smaller than that of the inverter.</li> </ul>			
Corrective action	<ul style="list-style-type: none"> <li>Wire the cables properly.</li> <li>Check the <i>Pr. 251 Output phase loss protection selection</i> setting.</li> </ul>			

Operation panel indication	E.OHT	<b>E.OHT</b>	FR-PU04 FR-PU07	OH Fault
Name	External thermal relay operation			
Description	If the external thermal relay provided for motor overheat protection or the internally mounted temperature relay in the motor, etc. switches on (contacts open), the inverter output is stopped. Functions when "7" (OH signal) is set to any of <i>Pr. 178 to Pr. 184 (input terminal function selection)</i> . This protective function does not function in the initial status (OH signal is not assigned).			
Check point	<ul style="list-style-type: none"> <li>Check for motor overheating.</li> <li>Check that the value of 7 (OH signal) is set correctly in any of <i>Pr. 178 to Pr. 184 (input terminal function selection)</i>.</li> </ul>			
Corrective action	<ul style="list-style-type: none"> <li>Reduce the load and frequency of operation.</li> <li>Even if the relay contacts are reset automatically, the inverter will not restart unless it is reset.</li> </ul>			

Operation panel indication	E.OP1	<b>E.OP 1</b>	FR-PU04 FR-PU07	Option slot alarm 1
Name	Communication option fault			
Description	Stops the inverter output when a communication line fault occurs in the communication option.			
Check point	<ol style="list-style-type: none"> <li>Check for a wrong option function setting and operation.</li> <li>Check that the plug-in option unit is plugged into the connector securely.</li> <li>Check for a break in the communication cable.</li> <li>Check that the terminating resistor is fitted properly.</li> </ol>			
Corrective action	<ol style="list-style-type: none"> <li>Check the option function setting, etc.</li> <li>Connect the plug-in option securely.</li> <li>Check the connection of communication cable.</li> <li>Connect the terminating resistor correctly.</li> </ol>			

Operation panel indication	E. 1	<b>E. 1</b>	FR-PU04 FR-PU07	Fault 1
Name	Option fault			
Description	Stops the inverter output if a contact fault or the like of the connector between the inverter and communication option occurs. Appears when the switch for the manufacturer setting of the plug-in option is changed.			
Check point	<ol style="list-style-type: none"> <li>Check that the plug-in option unit is plugged into the connector securely.</li> <li>Check for excess electrical noises around the inverter.</li> <li>Check the switch position for the manufacturer setting of the plug-in option.</li> </ol>			
Corrective action	<ol style="list-style-type: none"> <li>Connect the plug-in option securely.</li> <li>Take measures against noises if there are devices producing excess electrical noises around the inverter. If the problem still persists after taking the above measure, please contact your sales representative.</li> <li>Return the switch position for the manufacturer setting of the plug-in option to the initial status. (  Refer to the instruction manual of each option)</li> </ol>			

Operation panel indication	E.PE	<b>E. PE</b>	FR-PU04 FR-PU07	Corrupt Memry
Name	Parameter storage device fault (control circuit board)			
Description	Appears when a fault occurred in the stored parameters. (EEPROM fault)			
Check point	Check for too many number of parameter write times.			
Corrective action	Please contact your sales representative. When performing parameter write frequently for communication purposes, set "1" in <i>Pr. 342</i> to enable RAM write. Note that powering off returns the inverter to the status before RAM write.			



Operation Panel Indication	E.PE2	E.PE2	FR-PU04	Fault 14
			FR-PU07	PR storage alarm
Name	Internal board fault			
Description	When a combination of control board and main circuit board is wrong, the inverter is tripped.			
Check point	—			
Corrective action	Please contact your sales representative. (For parts replacement, consult the nearest Mitsubishi FA Center.)			

Operation panel indication	E.PUE	E.PUE	FR-PU04	PU Leave Out
			FR-PU07	
Name	PU disconnection			
Description	<ul style="list-style-type: none"> <li>This function stops the inverter output if communication between the inverter and PU is suspended, e.g. the parameter unit is disconnected, when "2", "3", "16" or "17" was set in <i>Pr. 75 Reset selection/disconnected PU detection/PU stop selection</i>.</li> <li>This function stops the inverter output when communication errors occurred consecutively for more than permissible number of retries when a value other than "9999" is set in <i>Pr. 121 Number of PU communication retries</i> during the RS-485 communication with the PU connector.</li> <li>This function also stops the inverter output if communication is broken within the period of time set in <i>Pr. 122 PU communication check time interval</i> during the RS-485 communication with the PU connector.</li> </ul>			
Check point	<ul style="list-style-type: none"> <li>Check that the parameter unit (FR-PU04/FR-PU07) is fitted tightly.</li> <li>Check the <i>Pr. 75</i> setting.</li> </ul>			
Corrective action	Connect the parameter unit (FR-PU04/FR-PU07) securely.			

Operation panel indication	E.RET	E.RET	FR-PU04	Retry No Over
			FR-PU07	
Name	Retry count excess			
Description	If operation cannot be resumed properly within the number of retries set, this function trips the inverter. Functions only when <i>Pr. 67 Number of retries at fault occurrence</i> is set. When the initial value ( <i>Pr. 67</i> = "0") is set, this protective function does not function.			
Check point	Find the cause of fault occurrence.			
Corrective action	Eliminate the cause of the error preceding this error indication.			

Operation panel indication	E. 6	E. 6	FR-PU04 FR-PU07	Fault 6
	E. 7	E. 7		Fault 7
	E.CPU	E.CPU		CPU Fault
Name	CPU fault			
Description	Stops the inverter output if the communication fault of the built-in CPU occurs.			
Check point	Check for devices producing excess electrical noises around the inverter.			
Corrective action	<ul style="list-style-type: none"> <li>Take measures against noises if there are devices producing excess electrical noises around the inverter.</li> <li>Please contact your sales representative.</li> </ul>			

Operation panel indication	E.MB4 to 7	E.MB4 to	FR-PU04 FR-PU07	E.MB4 Fault to E.MB7 Fault
		E.MB7		
Name	Brake sequence fault			
Description	<ul style="list-style-type: none"> <li>The inverter output is stopped when a sequence error occurs during use of the brake sequence function (<i>Pr. 278 to Pr. 283</i>). This protective function does not function in the initial status. (<i>Refer to page 127</i>).</li> </ul>			
Check point	Find the cause of alarm occurrence.			
Corrective action	Check the set parameters and perform wiring properly.			

Operation panel indication	E.IOH	E.IOH	FR-PU04	Fault 14
			FR-PU07	Inrush overheat
Name	Inrush current limit circuit fault			
Description	This function is activated when the resistor of the inrush current limit circuit overheats. The inrush current limit circuit fault			
Check point	Check that frequent power ON/OFF is not repeated.			
Corrective action	Configure a circuit where frequent power ON/OFF is not repeated. If the problem still persists after taking the above measure, please contact your sales representative.			

## Correspondences between digital and actual characters

Operation panel indication	E.AIE		FR-PU04	Fault 14
			FR-PU07	Analog in error
Name	Analog input fault			
Description	Appears when 30mA or more is input or a voltage (7.5V or more) is input with the terminal 4 set to current input.			
Check point	Check the setting of <i>Pr. 267 Terminal 4 input selection</i> and voltage/current input switch. (Refer to page 168).			
Corrective action	Either give a frequency command by current input or set <i>Pr. 267 Terminal 4 input selection</i> , and voltage/current input switch to voltage input.			

Operation panel indication	E.USB		FR-PU04	Fault 14
			FR-PU07	USB comm error
Name	USB communication fault			
Description	When communication has broken during the time set in <i>Pr. 548 USB communication check time interval</i> , this function stops the inverter output.			
Check point	<ul style="list-style-type: none"> <li>Check the USB communication cable.</li> </ul>			
Corrective action	<ul style="list-style-type: none"> <li>Check the <i>Pr. 548 USB communication check time interval</i> setting.</li> <li>Check the USB communication cable.</li> <li>Increase the <i>Pr. 548 USB communication check time interval</i> setting. Or, change the setting to 9999. (Refer to page 233).</li> </ul>			

Operation panel indication	E.13		FR-PU04	Fault 13
			FR-PU07	
Name	Internal circuit fault			
Description	Appears when an internal circuit fault occurred.			
Corrective action	Please contact your sales representative.			



### NOTE

- If protective functions of E.ILF, E.PE2, E.AIE, E.IOH, E.USB are activated when using the FR-PU04, "Fault 14" is displayed.  
Also when the faults history is checked on the FR-PU04, the display is "E.14".
- If faults other than the above appear, contact your sales representative.

## 5.4 Correspondences between digital and actual characters

There are the following correspondences between the actual alphanumeric characters and the digital characters displayed on the operation panel:

Actual	Digital	Actual	Digital	Actual	Digital
0		A		M	
1		B		N	
2		C		O	
3		D		o	
4		E		P	
5		F		S	
6		G		T	
7		H		U	
8		I		V	
9		J		r	
		L		-	

## 5.5 Check first when you have some troubles



### POINT

If the cause is still unknown after every check, it is recommended to initialize the parameters (initial value) then re-set the required parameter values and check again.

### 5.5.1 Motor will not start

1) Check the *Pr. 0 Torque boost* setting if V/F control is exercised. (Refer to page 77)

2) Check the main circuit.

- Check that a proper power supply voltage is applied. (Operation panel display is provided.)
- Check that the motor is connected properly.
- Check that the jumper across P/+-P1 is connected.

3) Check the input signals

- Check that the start signal is input.
- Check that both the forward and reverse rotation start signals are not input simultaneously.
- Check that the frequency setting signal is not zero. (When the frequency command is 0Hz and the start command is entered, RUN LED of the operation panel flickers.)
- Check that the AU signal is on when terminal 4 is used for frequency setting.
- Check that the output stop signal (MRS) or reset signal (RES) is not on.
- Check that the sink or source jumper connector is fitted securely. (Refer to page 23)

4) Check the parameter settings

- Check that *Pr. 78 Reverse rotation prevention selection* is not set.
- Check that the *Pr. 79 Operation mode selection* setting is correct.
- Check that the bias and gain (*calibration parameter C2 to C7*) settings are correct.
- Check that the starting frequency *Pr. 13 Starting frequency* setting is not greater than the running frequency.
- Check that frequency settings of each running frequency (such as multi-speed operation) are not zero. Check that especially the maximum frequency *Pr. 1 Maximum frequency* is not zero.
- Check that the *Pr. 15 Jog frequency* setting is not lower than the *Pr. 13 Starting frequency* value.
- Check that the operation location by *Pr. 550* and *Pr. 551* is appropriate. (Example: write from the operation panel is disabled when USB is connected)  
(Refer to page 259).

5) Inspection of load

- Check that the load is not too heavy.
- Check that the shaft is not locked.

6) Others

- Check that ALARM lamp is not lit.
- Check that the operation panel display does not show a fault (e.g. E.OC1).

### 5.5.2 Motor generates abnormal noise

— No carrier frequency noises (metallic noises) are generated.

- Soft-PWM control to change the motor tone into an unoffending complex tone is factory-set to valid by *Pr. 72 PWM frequency selection*.

Adjust *Pr. 72 PWM frequency selection* to change the motor tone.

— Check for any mechanical looseness.

— Contact the motor manufacturer.

### **5.5.3 Motor generates heat abnormally**

- Is the fan for the motor is running? (Check for dust accumulated.)
- Check that the load is not too heavy. Lighten the load.
- Are the inverter output voltages (U, V, W) balanced?
- Check that the *Pr: 0 Torque boost* setting is correct.
- Was the motor type set? Check the setting of *Pr: 71 Applied motor*.
- When using any other manufacturer's motor, perform offline auto tuning. (Refer to page 113.)

### **5.5.4 Motor rotates in opposite direction**

- Check that the phase sequence of output terminals U, V and W is correct.
- Check that the start signals (forward rotation, reverse rotation) are connected properly. (Refer to page 20)
- Check that the *Pr: 40 RUN key rotation direction selection* setting is correct. (Refer to page 259).

### **5.5.5 Speed greatly differs from the setting**

- Check that the frequency setting signal is correct. (Measure the input signal level.)
- Check that the *Pr: 1, Pr: 2, Pr: 19, Pr: 245, calibration parameter Pr: 125, Pr: 126, C2 to C7* settings are correct.
- Check that the input signal lines are not affected by external noise. (use shielded cables)
- Check that the load is not too heavy.
- Check that the *Pr: 31 to Pr: 36 (frequency jump)* settings are correct.

### **5.5.6 Acceleration/deceleration is not smooth**

- Check that the acceleration and deceleration time settings are not too short.
- Check that the load is not too heavy.
- Check that the torque boost (*Pr: 0, Pr: 46*) setting is not too large to activate the stall function under V/F control.

### **5.5.7 Motor current is large**

- Check that the load is not too heavy.
- Check that the *Pr: 0 Torque boost* setting is correct.
- Check that the *Pr: 3 Base frequency* setting is correct.
- Check that the *Pr: 19 Base frequency voltage* setting is correct
- Check that the *Pr: 14 Load pattern selection* setting is correct.

### **5.5.8 Speed does not increase**

- Check that the *Pr: 1 Maximum frequency* setting is correct. (If you want to run the motor at 120Hz or more, set *Pr: 18 High speed maximum frequency*. (Refer to page 89).
- Check that the load is not too heavy. (In agitators, etc., load may become heavier in winter.)
- Check that the torque boost (*Pr: 0, Pr: 46*) setting is not too large to activate the stall function under V/F control.
- Check that the brake resistor is not connected to terminals P/+-P1 or P1-PR accidentally.

### 5.5.9 Speed varies during operation

When slip compensation is set under general-purpose magnetic flux vector control, or advanced magnetic flux vector control is exercised, the output frequency varies with load fluctuation between 0 and 2Hz. This is a normal operation and is not a fault.

#### 1) Inspection of load

— Check that the load is not varying.

#### 2) Check the input signals

— Check that the frequency setting signal is not varying.

— Check that the frequency setting signal is not affected by noise. Set filter to the analog input terminal using *Pr. 74 Input filter time constant*.

— Check for a malfunction due to undesirable currents when the transistor output unit is connected. (*Refer to page 24*)

#### 3) Others

— Check that the value of *Pr. 80 Motor capacity* and *Pr. 81 Number of motor poles* are correct to the inverter capacity and motor capacity under advanced magnetic flux vector control and general-purpose magnetic flux vector control.

— Check that the wiring length is not exceeding 30m (98.42 feet) when advanced magnetic flux vector control or general-purpose magnetic flux vector control is exercised. Perform offline auto tuning. (*Refer to page 113*).

— Check that the wiring length is not too long for V/F control.

— Change the *Pr. 19 Base frequency voltage* setting (about 3%) under V/F control.

### 5.5.10 Operation mode is not changed properly



If the operation mode does not change correctly, check the following:

#### 1) External input signal

— Check that the STF or STR signal is off. When it is on, the operation mode cannot be changed.

#### 2) Parameter setting

— Check the *Pr. 79* setting.

When the *Pr. 79 Operation mode selection* setting is "0" (initial value), the inverter is placed in the external operation mode at input power-on. At this time, press  on the operation panel (press  when the parameter unit (FR-PU04/FR-PU07) is used) to switch to the PU operation mode. For other values (1 to 4, 6, 7), the operation mode is limited accordingly.

— Check that the operation location by *Pr. 550* and *Pr. 551* is correct. (Example: write from the operation panel is disabled when USB is connected) (*Refer to page 259*).

### 5.5.11 Operation panel display is not operating

— Check that wiring is securely performed and installation is correct.

— Make sure that the connector is fitted securely across terminals P-P1.

### 5.5.12 Parameter write cannot be performed

— Make sure that operation is not being performed (signal STF or STR is not ON).

— Make sure that you are not attempting to set the parameter in the external operation mode.

— Check *Pr. 77 Parameter write selection*.

— Check *Pr. 161 Frequency setting/key lock operation selection*.

— Check that the operation location by *Pr. 550* and *Pr. 551* is correct. (Example: write from the operation panel is disabled when USB is connected)

(*Refer to page 259*).

# MEMO

# **6** PRECAUTIONS FOR MAINTENANCE AND INSPECTION

---

This chapter provides the "PRECAUTIONS FOR MAINTENANCE AND INSPECTION" of this product.

Always read the instructions before using the equipment

---

6.1	Inspection items.....	286
6.2	Measurement of main circuit voltages, currents and powers ..	293

1

2

3

4

5

6

7

The inverter is a static unit mainly consisting of semiconductor devices. Daily inspection must be performed to prevent any fault from occurring due to the adverse effects of the operating environment, such as temperature, humidity, dust, dirt and vibration, changes in the parts with time, service life, and other factors.

### ●Precautions for maintenance and inspection

For some short time after the power is switched off, a high voltage remains in the smoothing capacitor. When accessing the inverter for inspection, wait for at least 10 minutes after the power supply has been switched off, and then make sure that the voltage across the main circuit terminals P/+ - N/- of the inverter is not more than 30VDC using a tester, etc.

## 6.1 Inspection items

---

### 6.1.1 Daily inspection

Basically, check for the following faults during operation.

- (1) Motor operation fault
- (2) Improper installation environment
- (3) Cooling system fault
- (4) Abnormal vibration, abnormal noise
- (5) Abnormal overheat, discoloration

During operation, check the inverter input voltages using a tester.

### 6.1.2 Periodic inspection

Check the areas inaccessible during operation and requiring periodic inspection.

Consult us for periodic inspection.

- (1) Check for cooling system fault.....Clean the air filter, etc.
- (2) Tightening check and retightening.....The screws and bolts may become loose due to vibration, temperature changes, etc. Check and tighten them.  
Tighten them according to the specified tightening torque (*Refer to page 17, 25*).
- (3) Check the conductors and insulating materials for corrosion and damage.
- (4) Measure insulation resistance.
- (5) Check and change the cooling fan and relay.



### 6.1.3 Daily and periodic inspection

Area of Inspection	Inspection Item	Description	Interval		Corrective Action at Alarm Occurrence	Customer's Check	
			Daily	Periodic *2			
General	Surrounding environment	Check the ambient temperature, humidity, dirt, corrosive gas, oil mist, etc.	○		Improve environment		
	Overall unit	Check for unusual vibration and noise.	○		Check alarm location and retighten		
	Power supply voltage	Check that the main circuit voltages are normal.*1	○		Inspect the power supply		
Main circuit	General	(1) Check with megger (across main circuit terminals and earth (ground) terminal). (2) Check for loose screws and bolts. (3) Check for overheat traces on the parts. (4) Check for stain		○ ○ ○ ○	Contact the manufacturer Retighten Contact the manufacturer Clean		
	Conductors, cables	(1) Check conductors for distortion. (2) Check cable sheaths for breakage and deterioration (crack, discoloration, etc.)		○ ○	Contact the manufacturer Contact the manufacturer		
	Terminal block	Check for damage.		○	Stop the device and contact the manufacturer.		
	Smoothing aluminum electrolytic capacitor	(1) Check for liquid leakage. (2) Check for safety valve projection and bulge. (3) Visual check and judge by the life check of the main circuit capacitor (Refer to page 288)		○ ○ ○	Contact the manufacturer Contact the manufacturer		
	Relay	Check that the operation is normal and no chatter is heard.		○	Contact the manufacturer		
Control circuit, Protective circuit	Operation check	(1) Check that the output voltages across phases with the inverter operated alone is balanced (2) Check that no fault is found in protective and display circuits in a sequence protective operation test.		○ ○	Contact the manufacturer Contact the manufacturer		
		Parts check	Overall	(1) Check for unusual odor and discoloration. (2) Check for serious rust development		○ ○	Stop the device and contact the manufacturer. Contact the manufacturer
	Aluminum electrolytic capacitor		(1) Check for liquid leakage in a capacitor and deformation trace (2) Visual check and judge by the life check of the main circuit capacitor (Refer to page 288)		○ ○	Contact the manufacturer	
Cooling system	Cooling fan	(1) Check for unusual vibration and noise. (2) Check for loose screws and bolts (3) Check for stain	○	○ ○ ○	Replace the fan Retighten Clean		
	Heatsink	(1) Check for clogging (2) Check for stain		○ ○	Clean Clean		
Display	Indication	(1) Check that display is normal. (2) Check for stain	○	○	Contact the manufacturer Clean		
	Meter	Check that reading is normal	○		Stop the device and contact the manufacturer.		
Load motor	Operation check	Check for vibration and abnormal increase in operation noise	○		Stop the device and contact the manufacturer.		

\*1 It is recommended to install a device to monitor voltage for checking the power supply voltage to the inverter.

\*2 One to two years of periodic inspection cycle is recommended. However, it differs according to the installation environment. Consult us for periodic inspection.

## 6.1.4 Display of the life of the inverter parts

The self-diagnostic alarm is output when the life span of the control circuit capacitor, cooling fan and each parts of the inrush current limit circuit is near to give an indication of replacement time.

The life alarm output can be used as a guideline for life judgement.

Parts	Judgement Level
Main circuit capacitor	85% of the initial capacity
Control circuit capacitor	Estimated remaining life 10%
Inrush current limit circuit	Estimated remaining life 10% (Power on: 100,000 times left)
Cooling fan	Less than 50% of the predetermined speed



### POINT

Refer to page 251 to perform the life check of the inverter parts.

## 6.1.5 Checking the inverter and converter modules

### <Preparation>

- (1) Disconnect the external power supply cables (R/L1, S/L2, T/L3) and motor cables (U, V, W).
- (2) Prepare a tester. (Use 100Ω range.)

### <Checking method>

Change the polarity of the tester alternately at the inverter terminals R/L1, S/L2, T/L3, U, V, W, P/+ and N/-, and check for continuity.



### NOTE

1. Before measurement, check that the smoothing capacitor is discharged.
2. At the time of discontinuity, the measured value is almost  $\infty$ . When there is an instantaneous continuity, due to the smoothing capacitor, the tester may not indicate  $\infty$ . At the time of continuity, the measured value is several ten's-of ohms depending on the module type, circuit tester type, etc. If all measured values are almost the same, the modules are without fault.

### <Module device numbers and terminals to be checked>

	Tester Polarity		Measured Value	Tester Polarity		Measured Value
	+	-		+	-	
Converter module	D1	R/L1 P/+	Discontinuity	D4	R/L1 N/-	Continuity
		P/+ R/L1	Continuity		N/- R/L1	Discontinuity
	D2	S/L2 P/+	Discontinuity	D5	S/L2 N/-	Continuity
		P/+ S/L2	Continuity		N/- S/L2	Discontinuity
	D3	T/L3 P/+	Discontinuity	D6	T/L3 N/-	Continuity
		P/+ T/L3	Continuity		N/- T/L3	Discontinuity
Inverter module	TR1	U P/+	Discontinuity	TR4	U N/-	Continuity
		P/+ U	Continuity		N/- U	Discontinuity
	TR3	V P/+	Discontinuity	TR6	V N/-	Continuity
		P/+ V	Continuity		N/- V	Discontinuity
	TR5	W P/+	Discontinuity	TR2	W N/-	Continuity
		P/+ W	Continuity		N/- W	Discontinuity

(Assumes the use of an analog meter.)

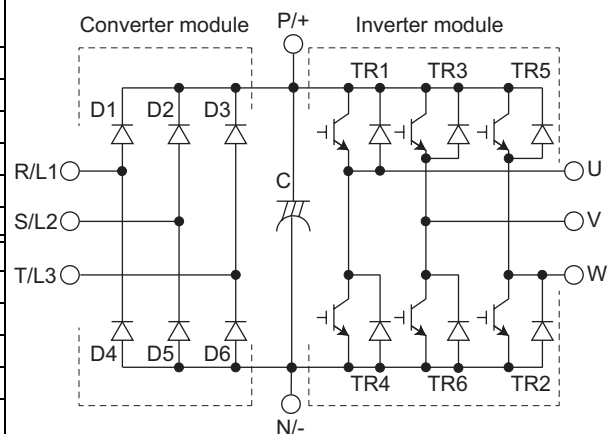

## 6.1.6 Cleaning

Always run the inverter in a clean status.

When cleaning the inverter, gently wipe dirty areas with a soft cloth immersed in neutral detergent or ethanol.



### NOTE

Do not use solvent, such as acetone, benzene, toluene and alcohol, as they will cause the inverter surface paint to peel off. The display, etc. of the operation panel and parameter unit (FR-PU04/FR-PU07) are vulnerable to detergent and alcohol. Therefore, avoid using them for cleaning.

### 6.1.7 Replacement of parts

The inverter consists of many electronic parts such as semiconductor devices.

The following parts may deteriorate with age because of their structures or physical characteristics, leading to reduced performance or fault of the inverter. For preventive maintenance, the parts must be replaced periodically.

Use the life check function as a guidance of parts replacement.

Part Name	Standard Replacement Interval *1	Description
Cooling fan	10 years	Replace (as required)
Main circuit smoothing capacitor	10 years *2	Replace (as required)
On-board smoothing capacitor	10 years	Replace the board (as required)
Relays	—	as required

\*1 Replacement years for when the yearly average ambient temperature is 40°C (104°F)  
(without corrosive gas, flammable gas, oil mist, dust and dirt etc.)

\*2 Output current: equivalent to rating current of the Mitsubishi standard motor (4 poles)



**NOTE**

For parts replacement, consult the nearest Mitsubishi FA Center.

#### (1) Cooling fan

The replacement interval of the cooling fan used for cooling the parts generating heat such as the main circuit semiconductor is greatly affected by the ambient temperature. When unusual noise and/or vibration is noticed during inspection, the cooling fan must be replaced immediately.



**NOTE**

For parts replacement, consult the nearest Mitsubishi FA Center.

Inverter Type	Fan Type	Units
FR-E720-080 to 175 FR-E740-040 to 095	MMF-06F24ES-RP1 BKO-CA1638H01	1
FR-E720-240, 330 FR-E740-120, 170	MMF-06F24ES-RP1 BKO-CA1638H01	2
FR-E720-470, 600	MMF-08D24ES-RP1 BKO-CA1639H01	2

The FR-E720-050 or less, FR-E740-026 or less is not provided with a cooling fan.

**●Removal**

- 1) Push the hooks from above and remove the fan cover.

FR-E720-175 or less  
FR-E740-095 or less

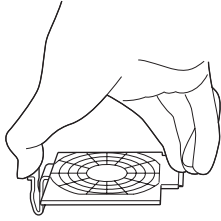

FR-E720-240 or more  
FR-E740-120 or more

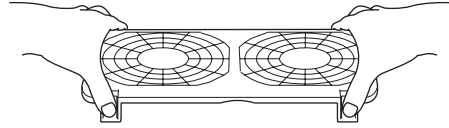

- 2) Disconnect the fan connectors.
- 3) Remove the fan.

FR-E720-175 or less  
FR-E740-095 or less

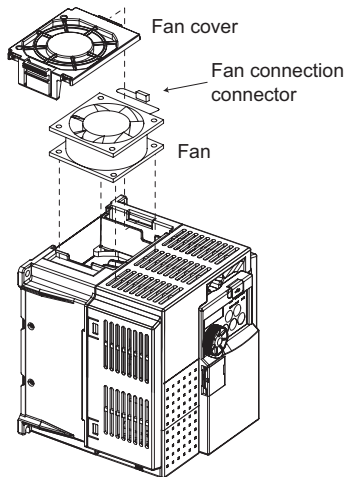

Example for FR-E740-095

FR-E720-240 or more  
FR-E740-120 or more

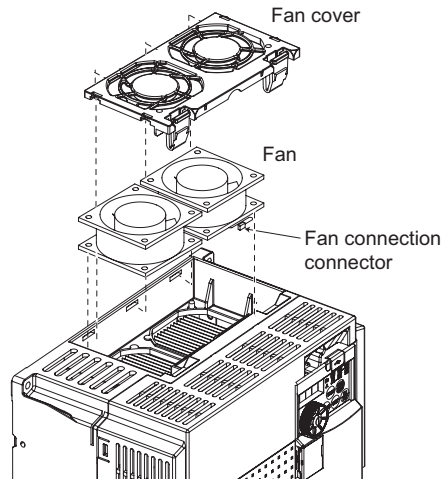

Example for FR-E740-120

●Reinstallation

- 1) After confirming the orientation of the fan, reinstall the fan so that the arrow on the left of "AIR FLOW" faces up.

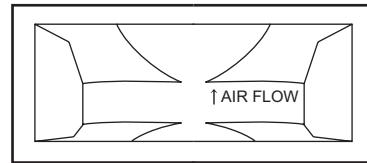

<Fan side face>

- 2) Reconnect the fan connectors.
- 3) When wiring, use care to avoid the cables being caught by the fan.

FR-E720-175 or less  
FR-E740-095 or less

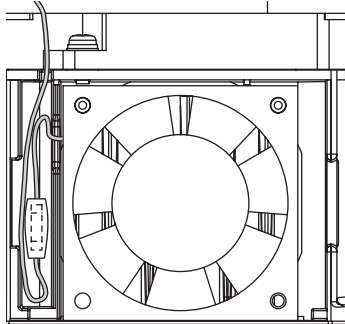

FR-E720-240 or more  
FR-E740-120 or more

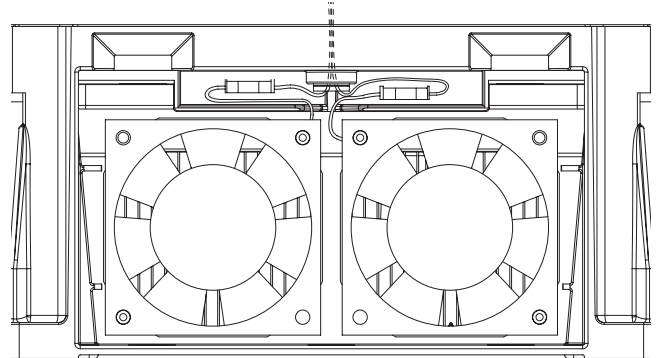

- 4) Reinstall the fan cover.

FR-E720-175 or less  
FR-E740-095 or less

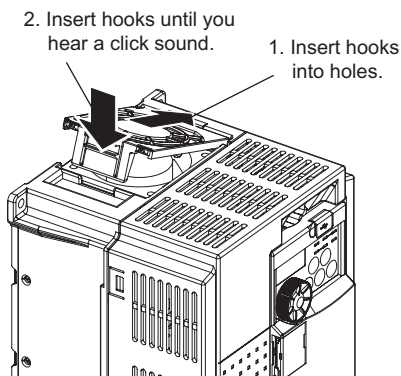

Example for FR-E740-095

FR-E720-240 or more  
FR-E740-120 or more

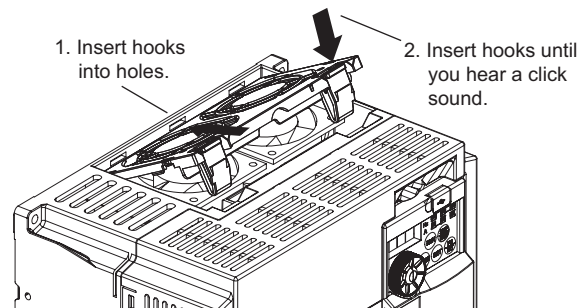

Example for FR-E740-120



**NOTE**

- Installing the fan in the opposite air flow direction can cause the inverter life to be shorter.
- Prevent the cable from being caught when installing a fan.
- Switch the power off before replacing fans. Since the inverter circuits are charged with voltage even after power off, replace fans only when the inverter cover is on the inverter to prevent an electric shock accident.

### (2) Smoothing capacitors

A large-capacity aluminum electrolytic capacitor is used for smoothing in the main circuit DC section, and an aluminum electrolytic capacitor is used for stabilizing the control power in the control circuit. Their characteristics are deteriorated by the adverse effects of ripple currents, etc. The replacement intervals greatly vary with the ambient temperature and operating conditions. When the inverter is operated in air-conditioned, normal environment conditions, replace the capacitors about every 10 years.

When a certain period of time has elapsed, the capacitors will deteriorate more rapidly. Check the capacitors at least every year (less than six months if the life will be expired soon).

The appearance criteria for inspection are as follows:

- 1) Case: Check the side and bottom faces for expansion
- 2) Sealing plate: Check for remarkable warp and extreme crack.
- 3) Check for external crack, discoloration, liquid leakage, etc. Judge that the capacitor has reached its life when the measured capacitance of the capacitor reduced below 80% of the rating.



#### POINT

Refer to page 251 to perform the life check of the main circuit capacitor.

### (3) Relays

To prevent a contact fault, etc., relays must be replaced according to the cumulative number of switching times (switching life).

### 6.1.8 Inverter replacement

The inverter can be replaced with the control circuit wiring kept connected. Before replacement, remove the wiring cover of the inverter.

- (1) Remove the installation screw of the control circuit terminal block.  
Pull the control circuit terminal downward.

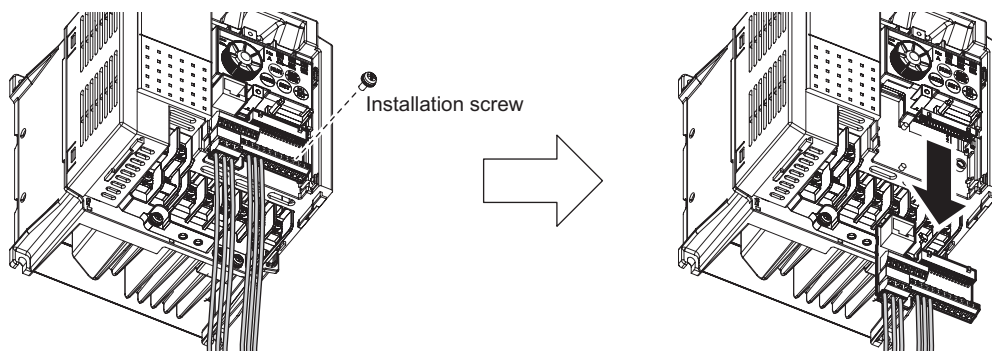

- (2) Using care not to bend the pins of the inverter's control circuit connector, reinstall the control circuit terminal block and fix it with the installation screw.

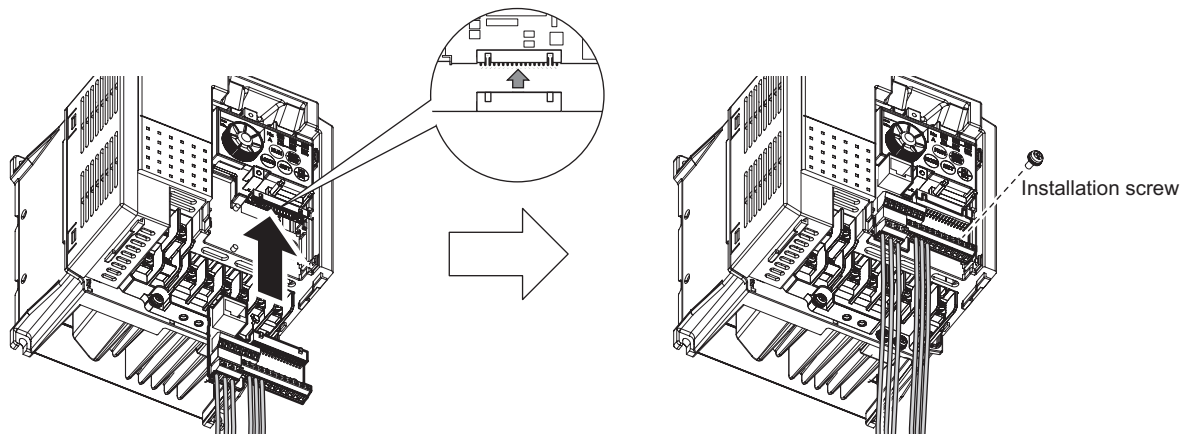

#### NOTE

- Before starting inverter replacement, switch power off, wait for at least 10 minutes, and then check the voltage with a tester and such to ensure safety.
- Calibration bias and gain changes when changing the control circuit terminal block. Use Pr. 645 and C1(Pr. 901) to calibrate again in that case.

## 6.2 Measurement of main circuit voltages, currents and powers

Since the voltages and currents on the inverter power supply and output sides include harmonics, measurement data depends on the instruments used and circuits measured.

When instruments for commercial frequency are used for measurement, measure the following circuits with the instruments given on the next page.

- When installing meters etc. on the inverter output side

When the inverter-to-motor wiring length is large, especially in the 400V class, small-capacity models, the meters and CTs may generate heat due to line-to-line leakage current. Therefore, choose the equipment which has enough allowance for the current rating.

To measure and display the output voltage and output current of the inverter, it is recommended to use the AM-5 terminal output function of the inverter.

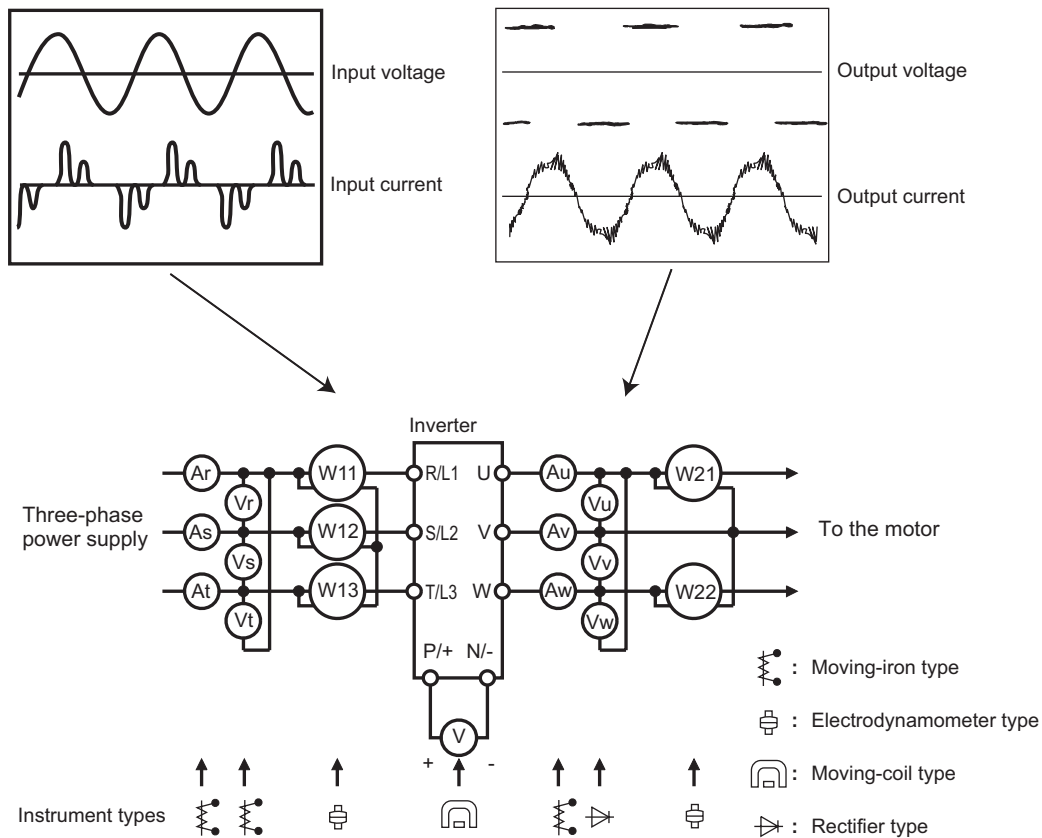

Examples of Measuring Points and Instruments

## Measuring Points and Instruments

Item	Measuring Point	Measuring Instrument	Remarks (Reference Measured Value)						
Power supply voltage V1	R/L1-S/L2 S/L2-T/L3 T/L3-R/L1	Moving-iron type AC voltmeter	Commercial power supply Within permissible AC voltage fluctuation ( <i>Refer to page 300</i> )						
Power supply side current I1	R/L1, S/L2, T/L3 line current	Moving-iron type AC ammeter							
Power supply side power P1	R/L1, S/L2, T/L3 and R/L1-S/L2, S/L2-T/L3, T/L3-R/L1,	Electrodynamic type single-phase wattmeter	P1=W11+W12+W13 (3-wattmeter method)						
Power supply side power factor Pf1	Calculate after measuring power supply voltage, power supply side current and power supply side power. $Pf_1 = \frac{P_1}{\sqrt{3}V_1 \times I_1} \times 100 \%$								
Output side voltage V2	Across U-V, V-W and W-U	Rectifier type AC voltage meter *1 (moving-iron type cannot measure)	Difference between the phases is within 1% of the maximum output voltage.						
Output side current I2	U, V and W line currents	Moving-iron type AC ammeter *2	Difference between the phases is 10% or lower of the rated inverter current.						
Output side power P2	U, V, W and U-V, V-W	Electrodynamic type single-phase wattmeter	P2 = W21 + W22 2-wattmeter method (or 3-wattmeter method)						
Output side power factor Pf2	Calculate in similar manner to power supply side power factor. $Pf_2 = \frac{P_2}{\sqrt{3}V_2 \times I_2} \times 100 \%$								
Converter output	Across P/+ -N/-	Moving-coil type (such as tester)	Inverter LED display is lit. 1.35 × V1 380V maximum during regeneration for 200V class 760V maximum during regeneration for 400V class						
Frequency setting signal	Across 2(+)-5 Across 4(+)-5	Moving-coil type (tester and such may be used) (internal resistance 50kΩ or more)	0 to 10VDC/4 to 20mADC						
Frequency setting power supply	Across 10(+)-5		5.2VDC	"5" is common.					
Frequency meter signal	Across AM(+)-5		Approx. 10VDC at maximum frequency (without frequency meter)						
Start signal	STF, STR		When open 20 to 30VDC ON voltage: 1V or less	"SD" is common.					
Select signal	Across RH, RM, RL(+)-SD								
Reset	Across RES(+)-SD								
Output stop	Across MRS(+)-SD								
Fault signal	Across A-C Across B-C	Moving-coil type (such as tester)	Continuity check *3 <table style="width: 100%; border: none;"> <tr> <td style="width: 50%; text-align: center;">&lt;Normal&gt;</td> <td style="width: 50%; text-align: center;">&lt;Fault&gt;</td> </tr> <tr> <td>Across A-C Discontinuity</td> <td>Continuity</td> </tr> <tr> <td>Across B-C Continuity</td> <td>Discontinuity</td> </tr> </table>	<Normal>	<Fault>	Across A-C Discontinuity	Continuity	Across B-C Continuity	Discontinuity
<Normal>	<Fault>								
Across A-C Discontinuity	Continuity								
Across B-C Continuity	Discontinuity								

\*1 Use an FFT to measure the output voltage accurately. An FA tester or general measuring instrument cannot measure accurately.

\*2 When the carrier frequency exceeds 5kHz, do not use this instrument since using it may increase eddy-current losses produced in metal parts inside the instrument, leading to burnout. In this case, use an approximate-effective value type.

\*3 When the setting of Pr. 192 A,B,C terminal function selection is positive logic



### 6.2.1 Measurement of powers

Using an electro-dynamometer type meter, measure the power in both the input and output sides of the inverter using the two- or three-wattmeter method. As the current is liable to be imbalanced especially in the input side, it is recommended to use the three-wattmeter method.

Examples of process value differences produced by different measuring meters are shown below.

An error will be produced by difference between measuring instruments, e.g. power calculation type and two- or three-wattmeter type three-phase wattmeter. When a CT is used in the current measuring side or when the meter contains a PT on the voltage measurement side, an error will also be produced due to the frequency characteristics of the CT and PT.

**[Measurement conditions]**

Constant-torque (100%) load, note that 60Hz or more should be constantly output 3.7kW, 4-pole motor, value indicated in 3-wattmeter method is 100%.

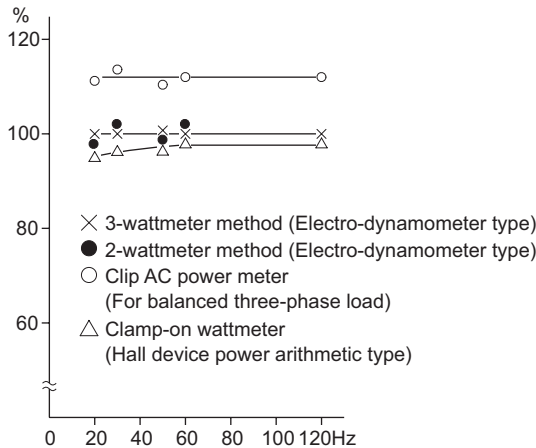

Example of Measuring Inverter Input Power

**[Measurement conditions]**

Constant-torque (100%) load, note that 60Hz or more should be constantly output 3.7kW, 4-pole motor, value indicated in 3-wattmeter method is 100%.

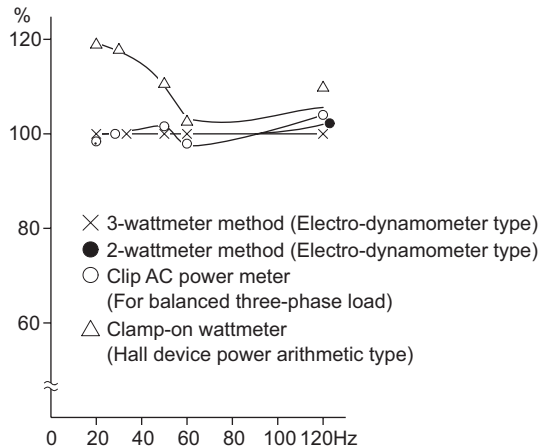

Example of Measuring Inverter Output Power

### 6.2.2 Measurement of voltages and use of PT

**(1) Inverter input side**

As the input side voltage has a sine wave and it is extremely small in distortion, accurate measurement can be made with an ordinary AC meter.

**(2) Inverter output side**

Since the output side voltage has a PWM-controlled rectangular wave, always use a rectifier type voltmeter. A needle type tester can not be used to measure the output side voltage as it indicates a value much greater than the actual value. A moving-iron type meter indicates an effective value which includes harmonics and therefore the value is larger than that of the fundamental wave. The value monitored on the operation panel is the inverter-controlled voltage itself. Hence, that value is accurate and it is recommended to monitor values using the operation panel.

**(3) PT**

No PT can be used in the output side of the inverter. Use a direct-reading meter. (A PT can be used in the input side of the inverter.)

### 6.2.3 Measurement of currents

Use a moving-iron type meter on both the input and output sides of the inverter. However, if the carrier frequency exceeds 5kHz, do not use that meter since an overcurrent losses produced in the internal metal parts of the meter will increase and the meter may burn out. In this case, use an approximate-effective value type.

Since current on the inverter input side tends to be unbalanced, measurement of three phases is recommended. Correct value can not be obtained by measuring only one or two phases. On the other hand, the unbalanced ratio of each phase of the output side current should be within 10%.

When a clamp ammeter is used, always use an effective value detection type. A mean value detection type produces a large error and may indicate an extremely smaller value than the actual value. The value monitored on the operation panel is accurate if the output frequency varies, and it is recommended to monitor values (provide analog output) using the operation panel.

Examples of process value differences produced by different measuring meters are shown below.

#### [Measurement conditions]

Value indicated by moving-iron type ammeter is 100%.

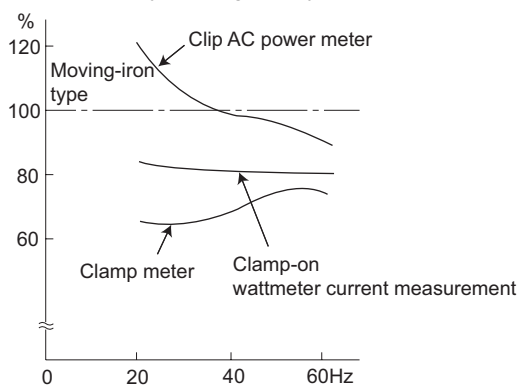

Example of measuring inverter input current

#### [Measurement conditions]

Value indicated by moving-iron type ammeter is 100%.

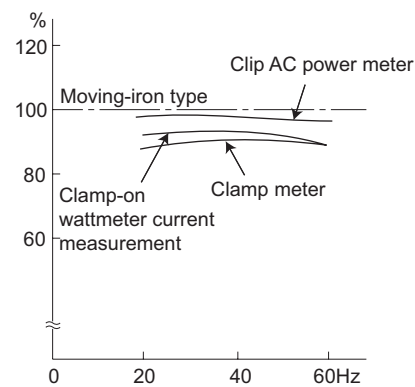

Example of measuring inverter output current

### 6.2.4 Use of CT and transducer

A CT may be used in both the input and output sides of the inverter, but the one used should have the largest possible VA ability because an error will increase if the frequency gets lower.

When using a transducer, use the effective value calculation type which is immune to harmonics.

### 6.2.5 Measurement of inverter input power factor

Calculate using effective power and apparent power. A power-factor meter can not indicate an exact value.

$$\begin{aligned} \text{Total power factor of the inverter} &= \frac{\text{Effective power}}{\text{Apparent power}} \\ &= \frac{\text{3-phase input power found by 3-wattmeter method}}{\sqrt{3} \times V (\text{power supply voltage}) \times I (\text{input current effective value})} \end{aligned}$$

### 6.2.6 Measurement of converter output voltage (across terminals P-N)

The output voltage of the converter is developed across terminals P-N and can be measured with a moving-coil type meter (tester). Although the voltage varies according to the power supply voltage, approximately 270V to 300V (540V to 600V for the 400V class) is output when no load is connected and voltage decreases when a load is connected.

When regenerative energy is returned from the motor during deceleration, for example, the converter output voltage rises to nearly 400 to 450V (800V to 900V for the 400V class) maximum.

### 6.2.7 Insulation resistance test using megger

- For the inverter, conduct the insulation resistance test on the main circuit only as shown below and do not perform the test on the control circuit. (Use a 500VDC megger.)

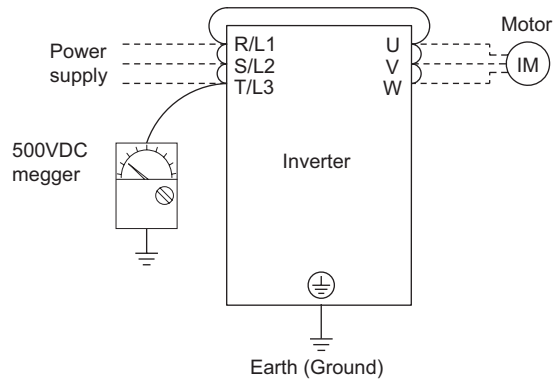

#### NOTE

- Before performing the insulation resistance test on the external circuit, disconnect the cables from all terminals of the inverter so that the test voltage is not applied to the inverter.
- For the continuity test of the control circuit, use a tester (high resistance range) and do not use the megger or buzzer.

### 6.2.8 Pressure test

Do not conduct a pressure test. Deterioration may occur.

# MEMO

# 7 SPECIFICATIONS

---

This chapter provides the "SPECIFICATIONS" of this product.  
Always read the instructions before using the equipment

---

7.1	Rating.....	300
7.2	Common specifications .....	302
7.3	Outline dimension drawings.....	303

1

2

3

4

5

6

7

## 7.1 Rating

### 7.1.1 Inverter rating

#### ● Three-phase 200V power supply

Type FR-E720-□□□-NA		008	015	030	050	080	110	175	240	330	470	600
Applicable motor capacity (kW (HP)) *1		0.1 (1/8)	0.2 (1/4)	0.4 (1/2)	0.75 (1)	1.5 (2)	2.2 (3)	3.7 (5)	5.5 (7.5)	7.5 (10)	11 (15)	15 (20)
Output	Rated capacity (kVA) *2	0.3	0.6	1.2	2.0	3.2	4.4	7.0	9.5	13.1	18.7	23.9
	Rated current (A) *6	0.8 (0.8)	1.5 (1.4)	3 (2.5)	5 (4.1)	8 (7)	11 (10)	17.5 (16.5)	24 (23)	33 (31)	47 (44)	60 (57)
	Overload current rating *3	150% 60s, 200% 3s (inverse time characteristics)										
	Voltage *4	Three-phase 200 to 240V										
Power supply	Rated input AC (DC) voltage/frequency	Three-phase 200 to 240V 50Hz/60Hz (283 to 339VDC *7)										
	Permissible AC (DC) voltage fluctuation	170 to 264V 50Hz/60Hz (240 to 373VDC *7)										
	Permissible frequency fluctuation	±5%										
	Power supply capacity (kVA) *5	0.4	0.8	1.5	2.5	4.5	5.5	9	12	17	20	28
Protective structure (JEM1030)	Enclosed type (IP20)											
Cooling system	Self-cooling					Forced air cooling						
Approximate mass (kg (lbs))	0.5 (1.10)	0.5 (1.10)	0.7 (1.54)	1.0 (2.2)	1.4 (3.09)	1.4 (3.09)	1.7 (3.75)	4.3 (9.48)	4.3 (9.48)	9.0 (19.84)	9.0 (19.84)	

\*1 The applicable motor capacity indicated is the maximum capacity applicable for use of the Mitsubishi 4-pole standard motor.

\*2 The rated output capacity indicated assumes that the output voltage is 230V.

\*3 The % value of the overload current rating indicated is the ratio of the overload current to the inverter's rated output current. For repeated duty, allow time for the inverter and motor to return to or below the temperatures under 100% load.

\*4 The maximum output voltage does not exceed the power supply voltage. The maximum output voltage can be changed within the setting range. However, the pulse voltage value of the inverter output side voltage remains unchanged at about  $\sqrt{2}$  that of the power supply.

\*5 The power supply capacity varies with the value of the power supply side inverter impedance (including those of the input reactor and cables).

\*6 Setting 2kHz or more in *Pr. 72 PWM frequency selection* to perform low acoustic noise operation in the ambient temperature exceeding 40°C(104°F), the rated output current is the value in parenthesis.

- \*7
- Connect DC power supply to terminal P/+ and N/-. Connect the plus side of the power supply to terminal P/+ and minus side to terminal N/-.
  - Since the voltage between P/+ and N/- may increase due to the regeneration energy from the motor and exceeds 415V temporarily, select the DC power supply which can withstand the voltage/energy during regeneration. If using the power supply which can not withstand voltage/energy during regeneration, insert diodes in series for reverse current prevention.
  - Although the FR-E700 series has the built-in inrush current limit circuit, select the DC power supply considering the inrush current at powering on as the inrush current four times of the rated inverter flows at powering on.
  - Since the power supply capacity depends on the output impedance of the power, select the power supply capacity which has enough allowance according to the AC power supply system capacity.

● Three-phase 400V power supply

Model FR-E740-□□□-NA		016	026	040	060	095	120	170
Applicable motor capacity (kW (HP)) <sup>*1</sup>		0.4 (1/2)	0.75 (1)	1.5 (2)	2.2 (3)	3.7 (5)	5.5 (7.5)	7.5 (10)
Output	Rated capacity (kVA) <sup>*2</sup>	1.2	2.0	3.0	4.6	7.2	9.1	13.0
	Rated current (A) <sup>*6</sup>	1.6 (1.4)	2.6 (2.2)	4.0 (3.8)	6.0 (5.4)	9.5 (8.7)	12	17
	Overload current rating <sup>*3</sup>	150% 60s, 200% 3s (inverse-time characteristics)						
	Voltage <sup>*4</sup>	Three phase 380 to 480V						
Power supply	Rated input voltage/frequency	Three-phase 380 to 480V 50Hz/60Hz						
	Permissible AC voltage fluctuation	325 to 528V 50Hz/60Hz						
	Permissible frequency fluctuation	±5%						
	Power supply capacity (kVA) <sup>*5</sup>	1.5	2.5	4.5	5.5	9.5	12	17
Protective structure (JEM1030)	Enclosed type (IP20)							
Cooling system	Self-cooling			Forced air cooling				
Approximate mass (kg (lbs))	1.4 (3.09)	1.4 (3.09)	1.9 (4.19)	1.9 (4.19)	1.9 (4.19)	3.2 (7.06)	3.2 (7.06)	

- \*1 The applicable motor capacity indicated is the maximum capacity applicable for use of the Mitsubishi 4-pole standard motor.
- \*2 The rated output capacity indicated assumes that the output voltage is 440V.
- \*3 The % value of the overload current rating indicated is the ratio of the overload current to the inverter's rated output current. For repeated duty, allow time for the inverter and motor to return to or below the temperatures under 100% load.
- \*4 The maximum output voltage does not exceed the power supply voltage. The maximum output voltage can be changed within the setting range. However, the pulse voltage value of the inverter output side voltage remains unchanged at about  $\sqrt{2}$  that of the power supply.
- \*5 The power supply capacity varies with the value of the power supply side inverter impedance (including those of the input reactor and cables).
- \*6 Setting 2kHz or more in *Pr. 72 PWM frequency selection* to perform low acoustic noise operation with the ambient temperature exceeding 40°C(104°F), the rated output current is the value in parenthesis.

## 7.2 Common specifications

Control specifications	Control method		Soft-PWM control/high carrier frequency PWM control (V/F control, advanced magnetic flux vector control, general-purpose magnetic flux vector control, optimum excitation control can be selected)	
	Output frequency range		0.2 to 400Hz	
	Frequency setting resolution	Analog input	0.06Hz/60Hz (terminal2, 4: 0 to 10V/10bit) 0.12Hz/60Hz (terminal2, 4: 0 to 5V/9bit) 0.06Hz/60Hz (terminal4: 4 to 20mA/10bit)	
		Digital input	0.01Hz	
	Frequency accuracy	Analog input	Within $\pm 0.5\%$ of the max. output frequency ( $25^{\circ}\text{C} \pm 10^{\circ}\text{C}$ )	
		Digital input	Within 0.01% of the set output frequency	
	Voltage/frequency characteristics		Base frequency can be set from 0 to 400Hz Constant torque/variable torque pattern can be selected	
	Starting torque		200% or more (at 0.5Hz)...when advanced magnetic flux vector control is set (3.7K or less)	
	Torque boost		Manual torque boost	
	Acceleration/deceleration time setting		0.01 to 360s, 0.1 to 3600s (acceleration and deceleration can be set individually), linear or S-pattern acceleration/deceleration mode can be selected.	
DC injection brake		Operation frequency (0 to 120Hz), operation time (0 to 10s), operation voltage (0 to 30%) variable		
Stall prevention operation level		Operation current level can be set (0 to 200% adjustable), whether to use the function or not can be selected		
Operation specifications	Frequency setting signal	Analog input	Two points Terminal 2: 0 to 10V, 0 to 5V can be selected Terminal 4: 0 to 10V, 0 to 5V, 4 to 20mA can be selected	
		Digital input	Entered from operation panel and parameter unit	
	Start signal		Forward and reverse rotation or start signal automatic self-holding input (3-wire input) can be selected.	
	Input signal		Seven points You can select from among multi-speed selection, remote setting, stop-on contact selection, second function selection, terminal 4 input selection, JOG operation selection, PID control valid terminal, brake opening completion signal, external thermal input, PU-external operation switchover, V/F switchover, output stop, start self-holding selection, forward rotation, reverse rotation command, inverter reset, PU-NET operation switchover, external-NET operation switchover, command source switchover, inverter operation enable signal, and PU operation external interlock	
	Operational functions		Maximum/minimum frequency setting, frequency jump operation, external thermal relay input selection, automatic restart after instantaneous power failure operation, forward/reverse rotation prevention, remote setting, brake sequence, second function, multi-speed operation, stop-on contact control, droop control, regeneration avoidance, slip compensation, operation mode selection, offline auto tuning function, PID control, computer link operation (RS-485)	
	Output signal	Output signal points	Open collector output	Two points
			Relay output	One point
		Operating status		You can select from among inverter operation, up-to-frequency, overload alarm, output frequency detection, regenerative brake prealarm, electronic thermal relay function prealarm, inverter operation ready, output current detection, zero current detection, PID lower limit, PID upper limit, PID forward/reverse rotation output, brake opening request, fan alarm*2, heatsink overheat pre-alarm, deceleration at an instantaneous power failure, PID control activated, during retry, life alarm, current average value monitor, remote output, alarm output, fault output, fault output 3, and maintenance timer alarm
		For meter Output points	Analog output	0 to 10VDC: one point
	For meter		You can select from among output frequency, motor current (steady), output voltage, frequency setting, motor torque, converter output voltage, regenerative brake duty, electronic thermal relay function load factor, output current peak value, converter output voltage peak value, reference voltage output, motor load factor, PID set point, PID measured value, output power 0 to 10VDC	
Indication	Operation panel	Operating status	You can select from among output frequency, motor current (steady), output voltage, frequency setting, cumulative energization time, actual operation time, motor torque, converter output voltage, regenerative brake duty, electronic thermal relay function load factor, output current peak value, converter output voltage peak value, motor load factor, PID set point, PID measured value, PID deviation, inverter I/O terminal monitor, I/O terminal option monitor, output power, cumulative power, motor thermal load factor, and inverter thermal load factor.	
			Fault definition	Fault definition is displayed when the fault occurs and the past 8 fault definitions (output voltage/current/frequency/cumulative energization time right before the fault occurs) are stored
	Additional display by the parameter unit (FR-PU04/FR-PU07) only	Operating status	Not used	
		Fault definition	Output voltage/current/frequency/cumulative energization time immediately before the fault occurs	
		Interactive guidance	Function (help) for operation guide	
Protective/warning function		<Protective functions> Overcurrent during acceleration, overcurrent during constant speed, overcurrent during deceleration, overvoltage during acceleration, overvoltage during constant speed, overvoltage during deceleration, inverter protection thermal operation, motor protection thermal operation, heatsink overheat, input phase failure, output side earth (ground) fault overcurrent at start*4, output phase failure, external thermal relay operation *4, option fault, parameter error, internal board fault, PU disconnection, retry count excess *4, CPU fault, brake transistor alarm, inrush resistance overheat, communication error, analog input error, USB communication error, brake sequence error 4 to 7 *4 <Warning functions> Fan alarm*2, overcurrent stall prevention, overvoltage stall prevention, PU stop, parameter write error, regenerative brake prealarm *4, electronic thermal relay function prealarm, maintenance output *4, undervoltage		
Environment	Ambient temperature		$-10^{\circ}\text{C}$ to $+50^{\circ}\text{C}$ ( $14^{\circ}\text{F}$ to $122^{\circ}\text{F}$ ) (non-freezing) *3	
	Ambient humidity		90%RH maximum (non-condensing)	
	Storage temperature*1		$-20^{\circ}\text{C}$ to $+65^{\circ}\text{C}$ ( $-4^{\circ}\text{F}$ to $149^{\circ}\text{F}$ )	
	Atmosphere		Indoors (without corrosive gas, flammable gas, oil mist, dust and dirt etc.)	
Altitude/vibration		Maximum 1000m (3280.80 feet) above sea level, $5.9\text{m/s}^2$ or less		

\*1 Temperatures applicable for a short time, e.g. in transit.

\*2 As the FR-E720-050 or less, FR-E740-026 or less is not provided with the cooling fan, this alarm does not function.

\*3 When using the inverters at the ambient temperature of  $40^{\circ}\text{C}$  ( $104^{\circ}\text{F}$ ) or less, the inverters can be installed closely attached (0cm clearance).

\*4 This protective function does not function in the initial status.



### 7.3 Outline dimension drawings

(1) 200V class

- FR-E720-008 to 050

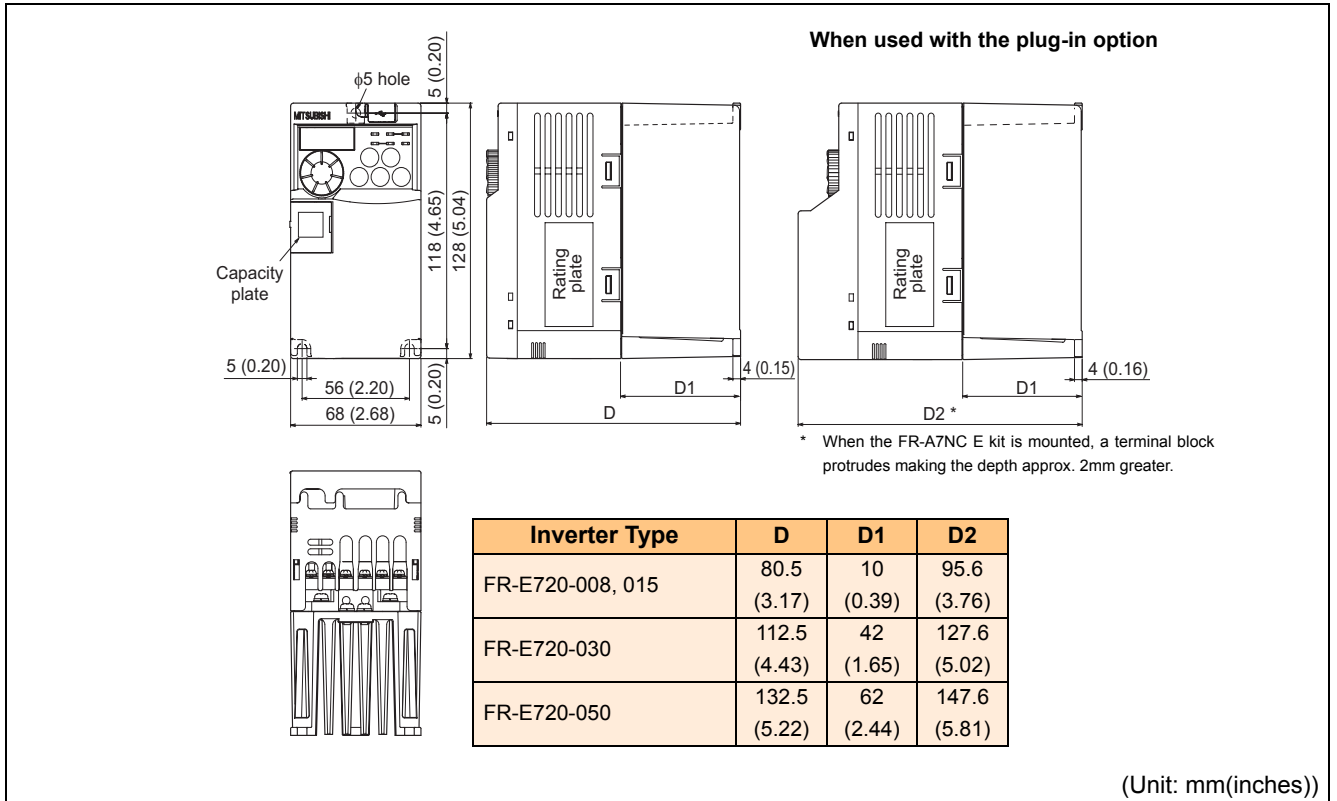

- FR-E720-080, 110

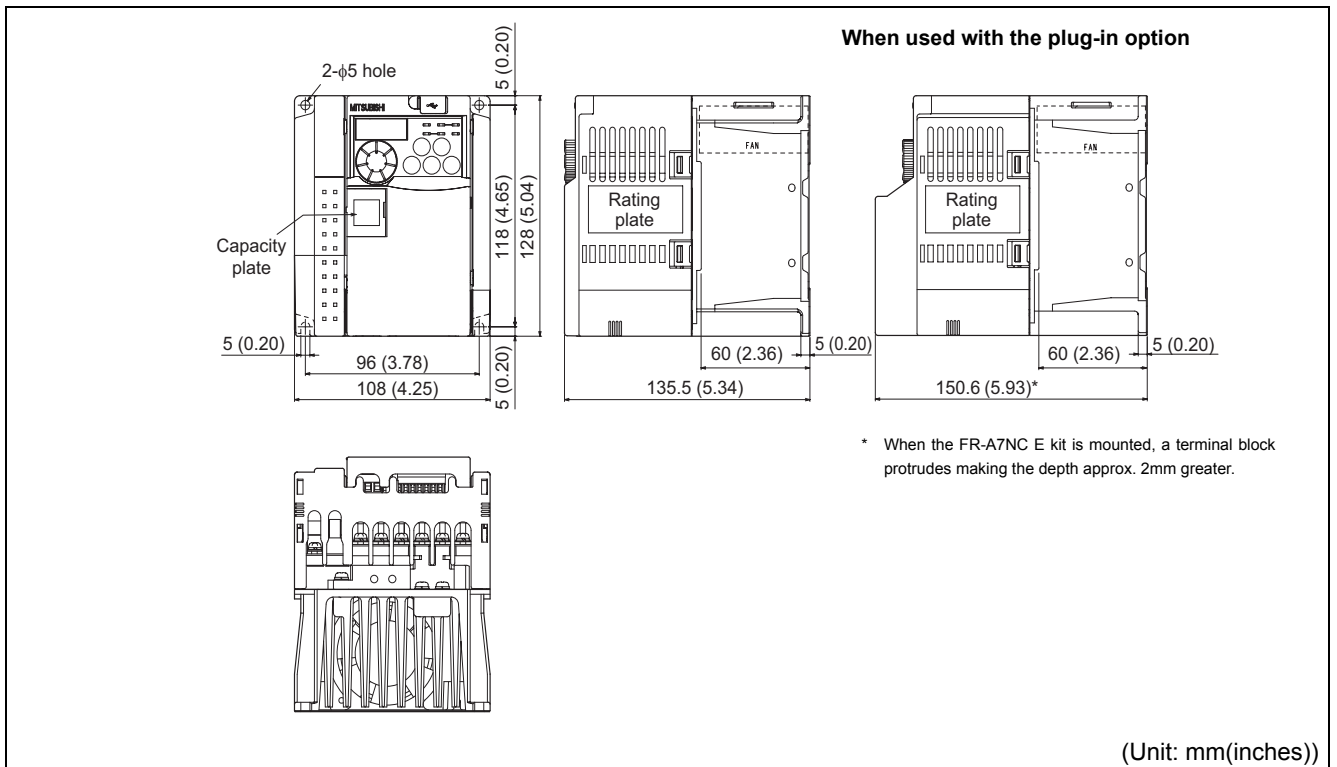

# Outline dimension drawings

## ●FR-E720-175

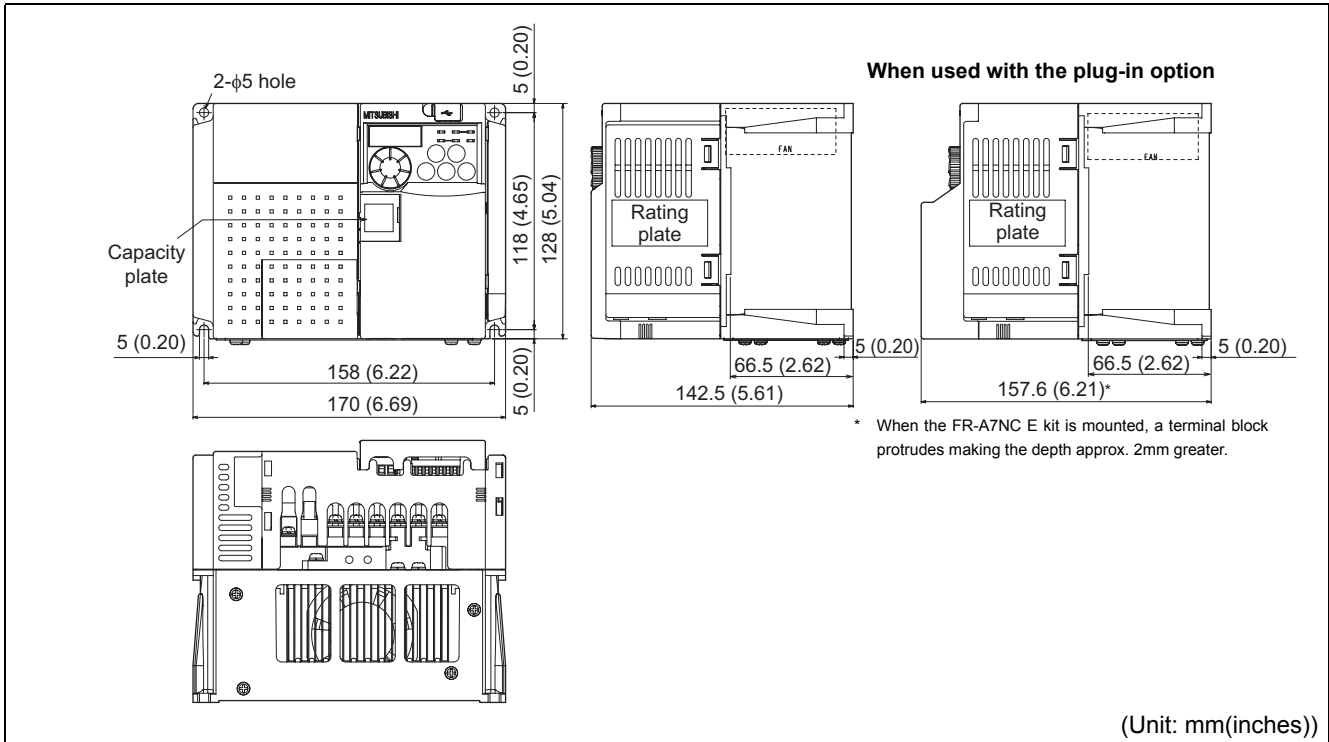

## ●FR-E720-240 to 600

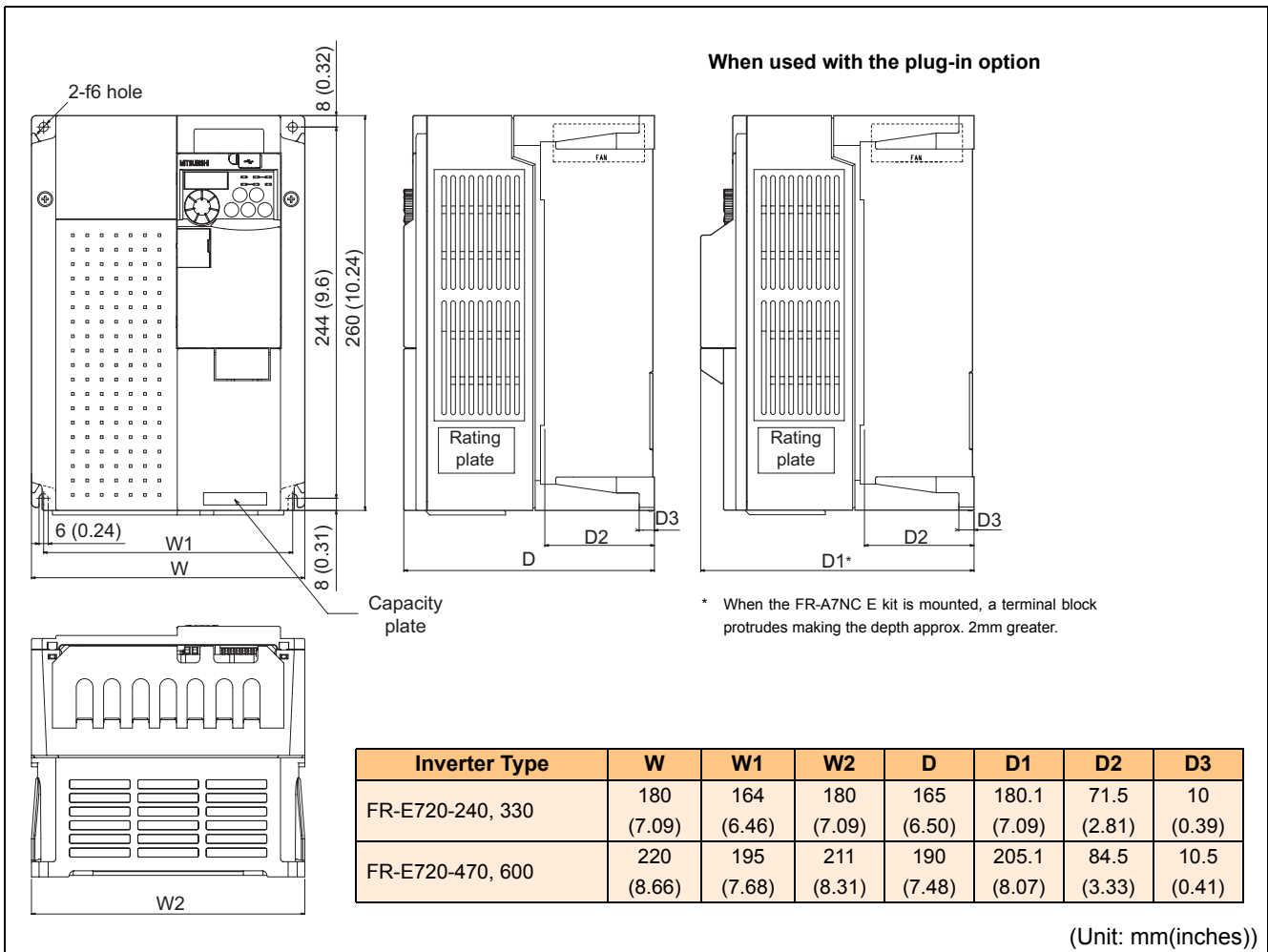

(2) 400V class

●FR-E740-016 to 095

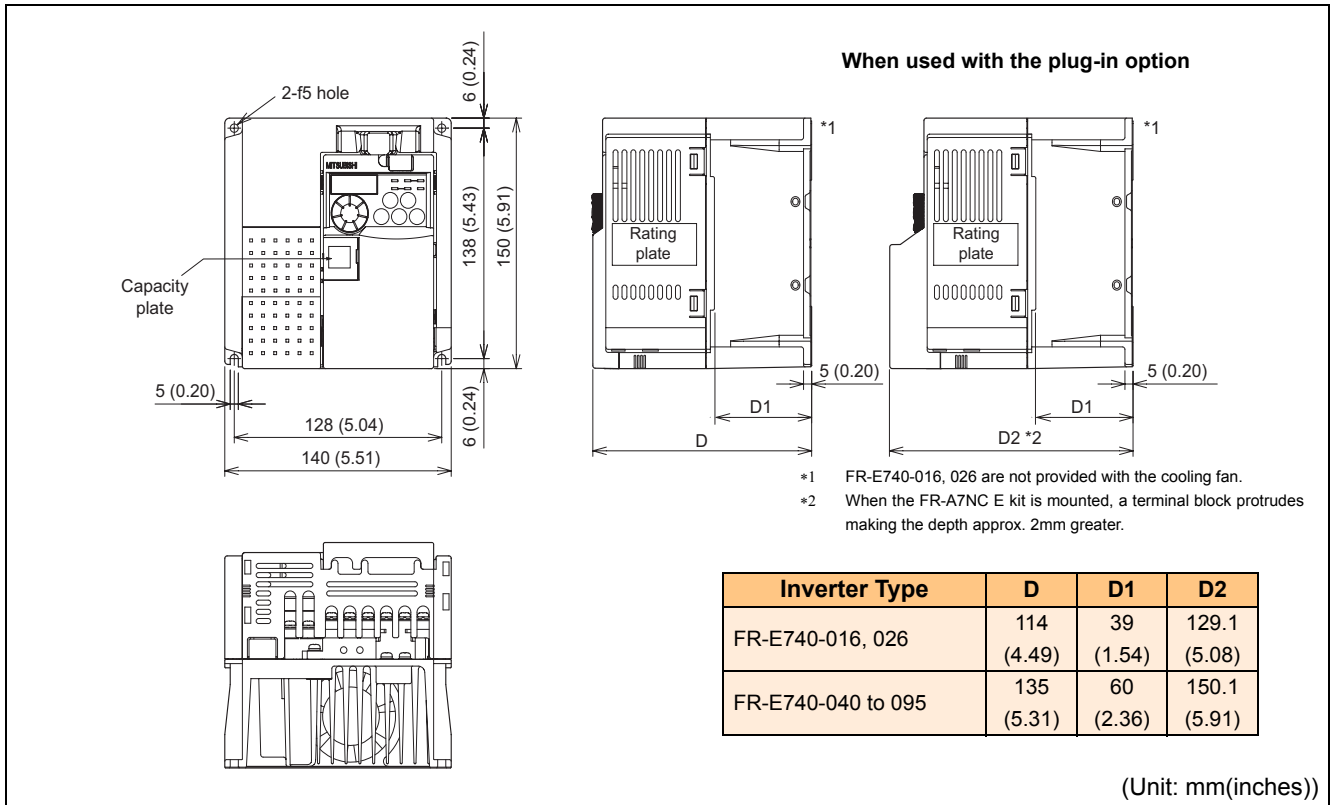

●FR-E740-120, 170

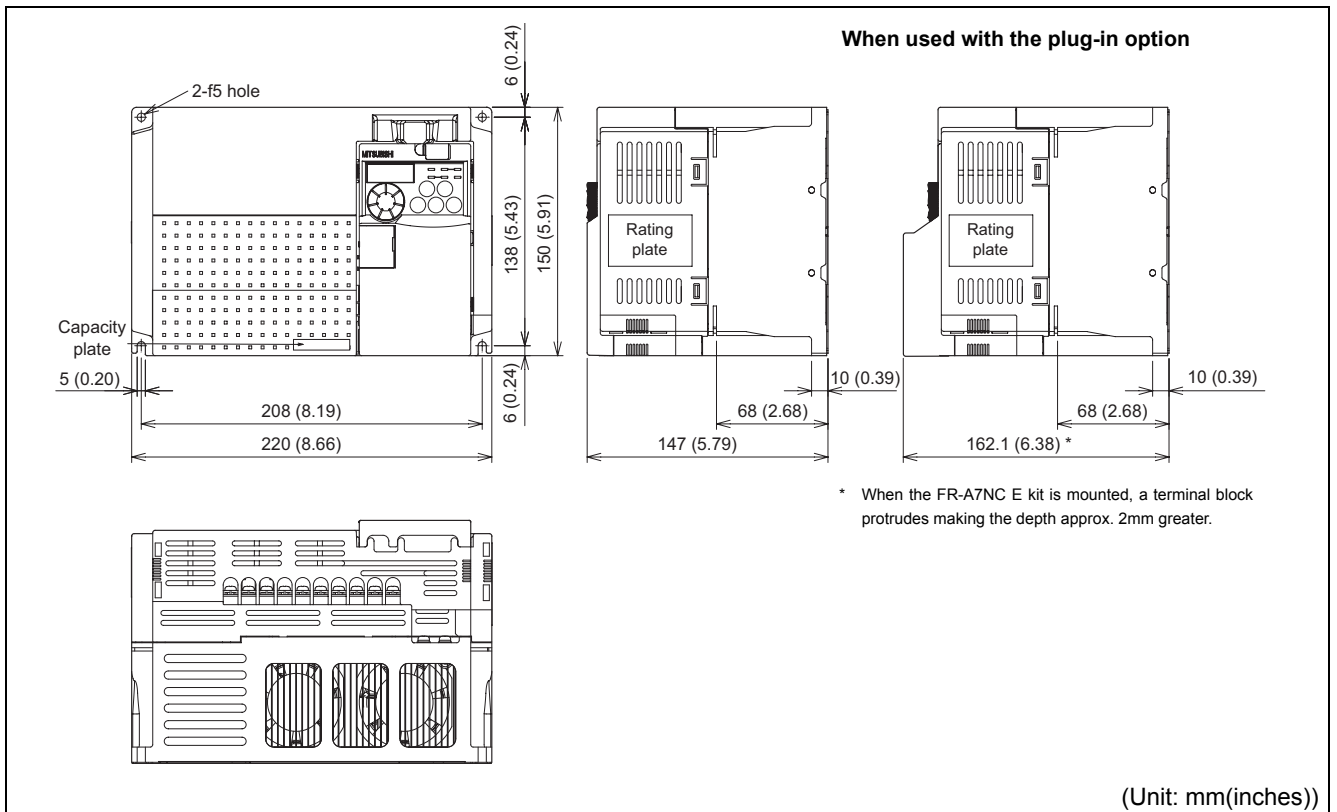

## ●Parameter unit (option) (FR-PU07)

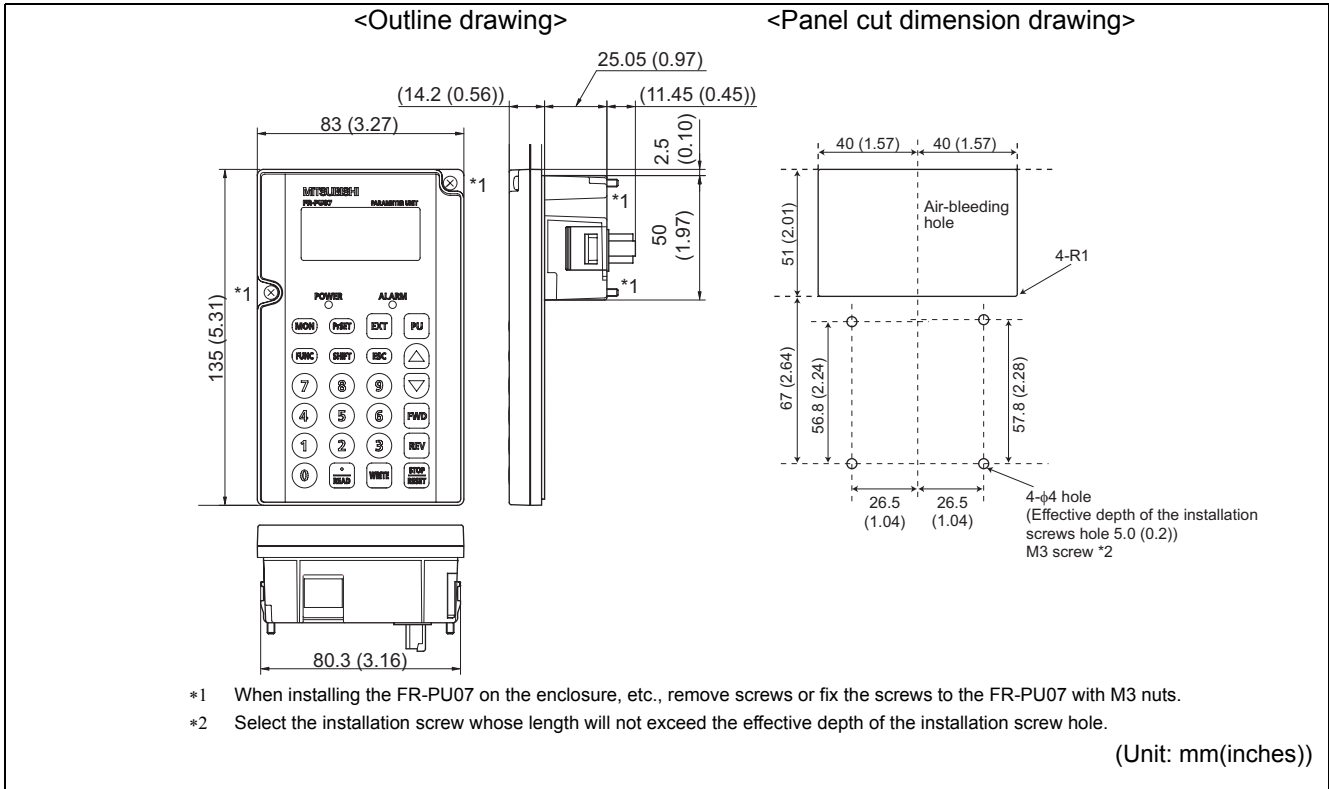

## ●Parameter unit (option) (FR-PU04)

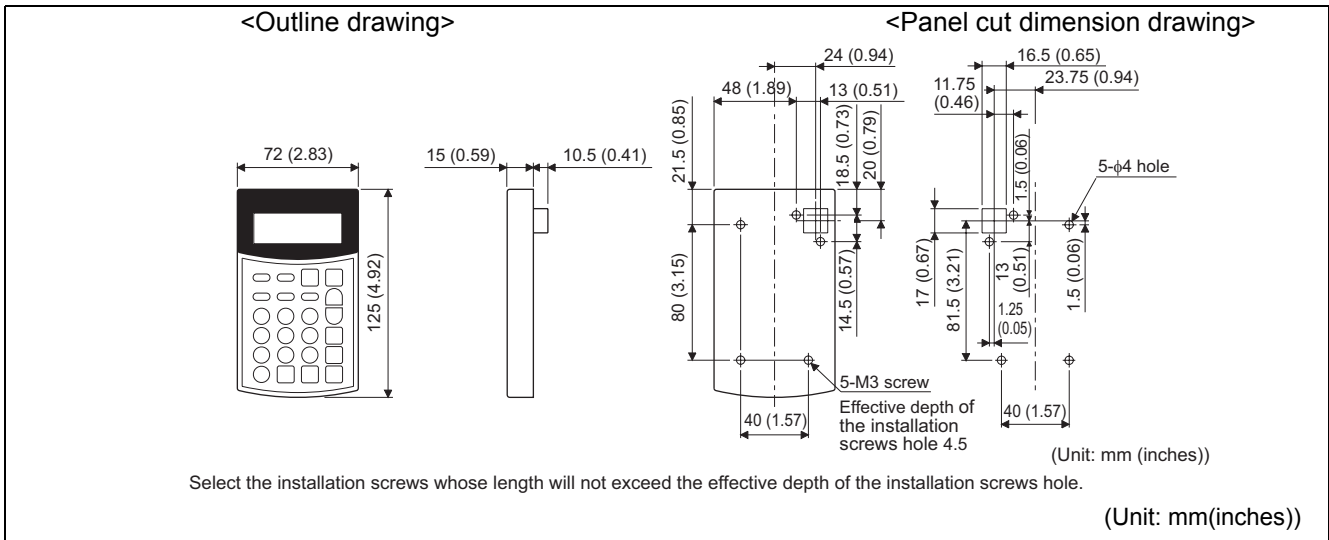

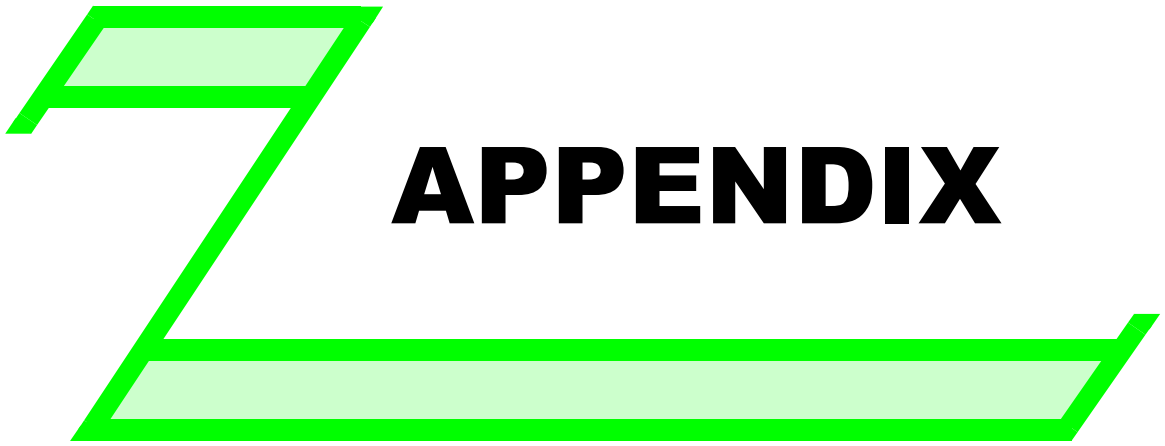
A large, stylized number '3' graphic. The top horizontal bar is light green with a dark green outline. The vertical stem is dark green. The bottom horizontal bar is light green with a dark green outline. The word 'APPENDIX' is centered to the right of the stem.

# **APPENDIX**

---

**This chapter provides the "APPENDIX" of this product.  
Always read the instructions before using the equipment.**

---

---

---

# APPENDIX

---

---

<b>Appendix1 For customers who have replaced the conventional model with this inverter</b>
--

## **Appendix 1-1 Replacement of the FR-E500 series**

### **(1) Instructions for installation**

- 1) Removal procedure of the front cover was changed. *(Refer to page 5)*
- 2) The operation panel cannot be removed from the inverter.
- 3) Plug-in options of the FR-E500 series are not compatible.
- 4) Setup software (FR-SW0-SETUP, FR-SW1-SETUP, FR-SW2-SETUP) can not be used.



### **(2) Instructions for continuous use of the FR-PU04 (parameter unit)**

- 1) For the FR-E700 series, many functions (parameters) have been added. User initial value list and user clear of the HELP function can not be used.
- 2) For the FR-E700 series, many protective functions have been added. These functions activate, but all faults are displayed as "Fault 14". When the faults history has been checked, "E.14" appears. Added faults display will not appear on the parameter unit.
- 3) User initial value setting can not be used.
- 4) User registration/clear (user group 2) can not be used.
- 5) Parameter copy/verification function can not be used.

### **(3) Parameter resetting**

It is easy if you use setup software (FR Configurator FR-SW3-SETUP).

#### (4) Main differences and compatibilities with the FR-E500 Series

Item	FR-E500	FR-E700
Control method	V/F control General-purpose magnetic flux vector control	V/F control General-purpose magnetic flux vector control Advanced magnetic flux vector control Optimum excitation control
Changed/cleared functions	Torque boost (Pr. 0) initial value FR-E520-1.5K to 7.5K: 6% FR-E540-1.5K to 3.7K: 6% FR-E540-5.5K, 7.5K: 4%	FR-E720-080 to 175: 4% FR-E720-240, 330: 3% FR-E740-040 to 095: 4% FR-E740-120, 170: 3%
	DC injection brake operation voltage (Pr. 12) initial value FR-E520-0.4K to 7.5K: 6%	FR-E720-030 to 330: 4%
	Frequency at 5V (10V) input (Pr. 38) Frequency at 20mA input frequency (Pr. 39) Second electronic thermal O/L relay (Pr. 48) Shortest acceleration/deceleration mode (Pr. 60)	Parameter number change (Pr. 125 Terminal 2 frequency setting gain frequency) (Pr. 126 Terminal 4 frequency setting gain frequency) (Pr. 51 Second electronic thermal O/L relay) (Pr. 60 Energy saving control selection) (Pr. 292 Automatic acceleration/deceleration)
	Reverse rotation from the inverter operation panel  Press  .	After setting "1" in Pr. 40 RUN key rotation direction selection , press  .
	FM terminal function selection (Pr. 54) setting, AM terminal function selection (Pr. 158) setting 0: Output frequency (initial value), 1: Output current, 2: Output voltage	AM terminal function selection (Pr. 158) setting  1: Output frequency (initial value), 2: Output current, 3: Output voltage
	Second applied motor Pr. 71 = 100 to 123	Pr. 450 Second applied motor
	Terminal 2 0 to 5V, 0 to 10V selection (Pr. 73) setting 0: 0 to 5V (initial value), 1: 0 to 10V	Pr. 73 Analog input selection 0: 0 to 10V 1: 0 to 5V (initial value)
	Operation mode selection (Pr. 79) Initial value 1: PU operation mode	Initial value 0: External operation mode is selected at power on
	Setting 8: Operation mode switching by external signal Setting general-purpose magnetic flux vector Pr. 80 ≠ 9999	Setting 8: deleted (X16 signal is used instead)  Pr. 80 ≠ 9999, Pr. 81 ≠ 9999, Pr. 800 = 30
	User group 1 (16), user group 2 (16) (Pr. 160, Pr. 173 to Pr. 175)	User group (16) only, setting methods were partially changed (Pr. 160, Pr. 172, Pr. 173)
	Input terminal function selection (Pr. 180 to Pr. 183) setting 5: MRS signal (output stop) 6: STOP signal (start self-holding selection)	Pr. 178 to Pr. 184 Input terminal function selection setting 5: JOG signal (jog operation selection) 6: None 24: MRS signal (output stop) 25: STOP signal (start self-holding selection)
	Cooling fan operation selection (Pr. 244) initial setting 0: Cooling fan operates in power-on status. Stop selection (Pr. 250) setting increments 1s	1: Cooling fan on/off control valid  0.1s
	RS-485 communication control source from the PU connector PU operation mode	Network operation mode (PU operation mode as FR-E500 when Pr. 551 = 2)
	Earth (ground) fault detection 400V class: Detects always	400V class: Detects only at a start
	Inrush current limit circuit	Provided for the 200V class 2.2K or more and 400V class Provided for the all capacity
	Control terminal block	Fixed terminal block (can not be removed) (+ screw M2.5) Removable terminal block (- screw M2 (M3 for terminal A, B, and C only)
Output signal	200V class: FM (pulse output) 400V class: AM (analog output) AM (analog output) for all voltage class	
Operation panel	Removable operation panel (PA02) Integrated operation panel (can not be removed)	
PU	FR-PU04 FR-PU07 FR-PU04 (some functions, such as parameter copy, are unavailable.)	
Plug-in option	Dedicated plug-in option (installation is incompatible)	
	for 400V class only FR-E5NC : CC-Link communication FR-E5ND : DeviceNet communication FR-E5NL : LonWorks communication	FR-A7AX E kit : 16bit digital input FR-A7AY E kit : Digital output, Extension analog output FR-A7AR E kit : Relay output FR-A7NC E kit : CC-Link communication FR-A7ND E kit : DeviceNet communication FR-A7NP E kit : PROFIBUS-DP communication FR-A7NL E kit : LonWorks communication
Installation size	0.1 to 7.5K are compatible in mounting dimensions	

REVISIONS

\*The manual number is given on the bottom left of the back cover.

Print Date	*Manual Number	Revision
Sep., 2007	IB(NA)-0600334ENG-A	First edition

 **For Maximum Safety**

- Mitsubishi inverters are not designed or manufactured to be used in equipment or systems in situations that can affect or endanger human life.
- When considering this product for operation in special applications such as machinery or systems used in passenger transportation, medical, aerospace, atomic power, electric power, or submarine repeating applications, please contact your nearest Mitsubishi sales representative.
- Although this product was manufactured under conditions of strict quality control, you are strongly advised to install safety devices to prevent serious accidents when it is used in facilities where breakdowns of the product are likely to cause a serious accident.
- Please do not use this product for loads other than three-phase induction motors.